

SHINDENGEN

Schottky Rectifiers (SBD)

Dual

DF10SC9

90V 10A

FEATURES

- SMT
- Tj150
- P_{RRSM} avalanche guaranteed
- High current capacity with Small Package

APPLICATION

- Switching power supply
- DC/DC converter
- Home Appliances, Office Equipment
- Telecommunication

OUTLINE DIMENSIONS

Case : STO-220

Unit : mm

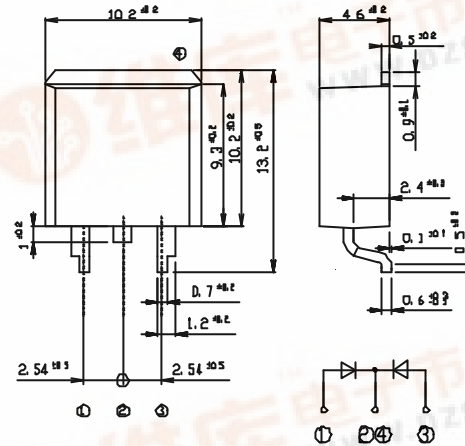

RATINGS

Absolute Maximum Ratings (If not specified Tc=25)

Item	Symbol	Conditions	Ratings	Unit
Storage Temperature	Tstg		-55 ~ 150	
Operating Junction Temperature	Tj		150	
Maximum Reverse Voltage	V _{RM}		90	V
Repetitive Peak Surge Reverse Voltage	V _{RRSM}	Pulse width 0.5ms, duty 1/40	100	V
Average Rectified Forward Current	I _O	50Hz sine wave, R-load, Rating for each diode I _O /2, Tc=131	10	A
Peak Surge Forward Current	I _{FSM}	50Hz sine wave, Non-repetitive 1 cycle peak value, Tj=125	150	A
Repetitive Peak Surge Reverse Power	P _{RRSM}	Pulse width 10 μs, Rating of per diode, Tj=25	330	W

Electrical Characteristics (If not specified Tc=25)

Item	Symbol	Conditions	Ratings	Unit
Forward Voltage	V _F	I _F =5A, Pulse measurement, Rating of per diode	Max.0.75	V
Reverse Current	I _R	V _R =V _{RM} , Pulse measurement, Rating of per diode	Max.3	mA
Junction Capacitance	C _j	f=1MHz, V _R =10V, Rating of per diode	Typ.185	pF
Thermal Resistance	θ _{JC}	junction to case	Max.1.2	/W

DF10SC9

Forward Voltage

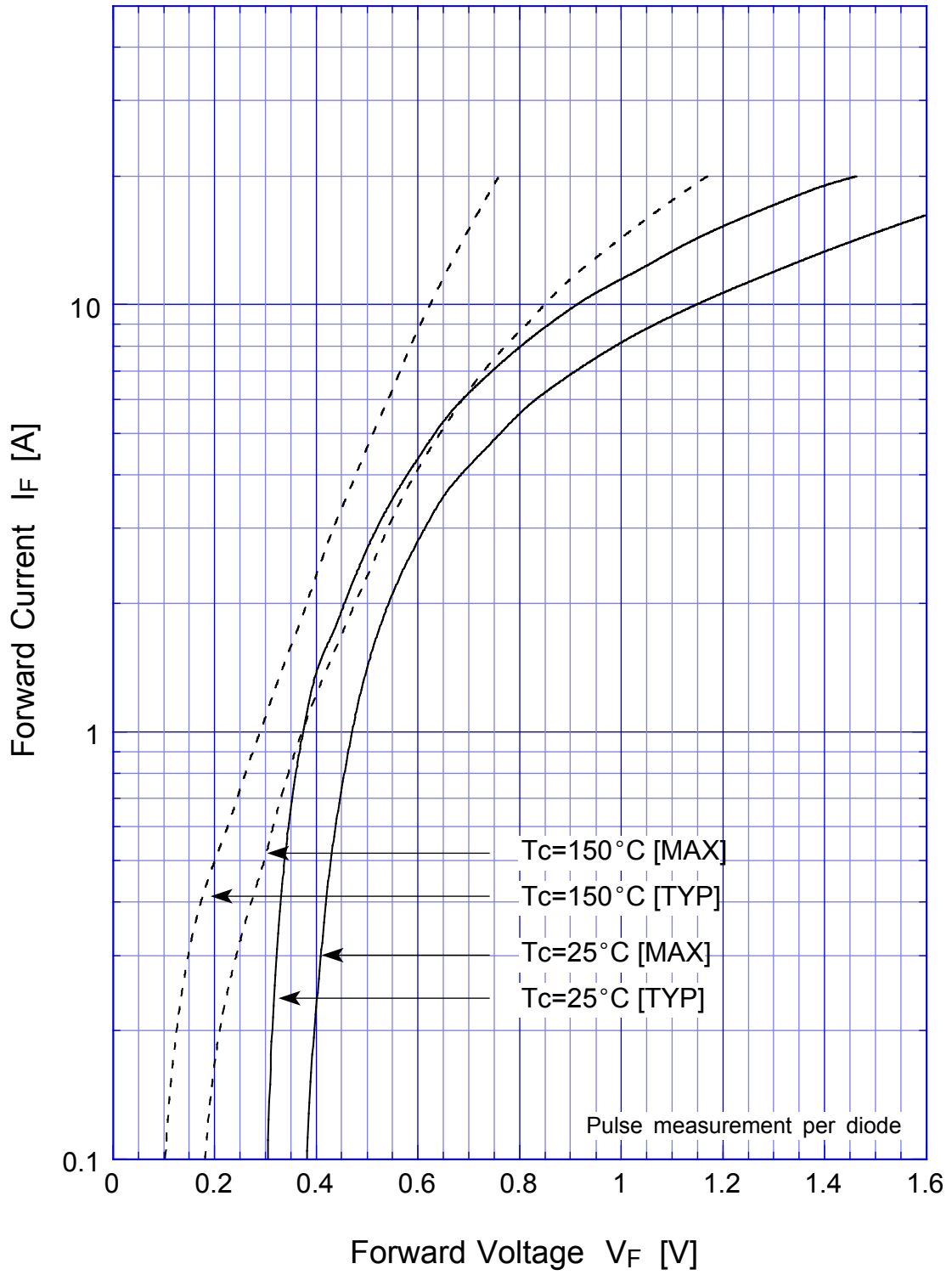

DF10SC9

Junction Capacitance

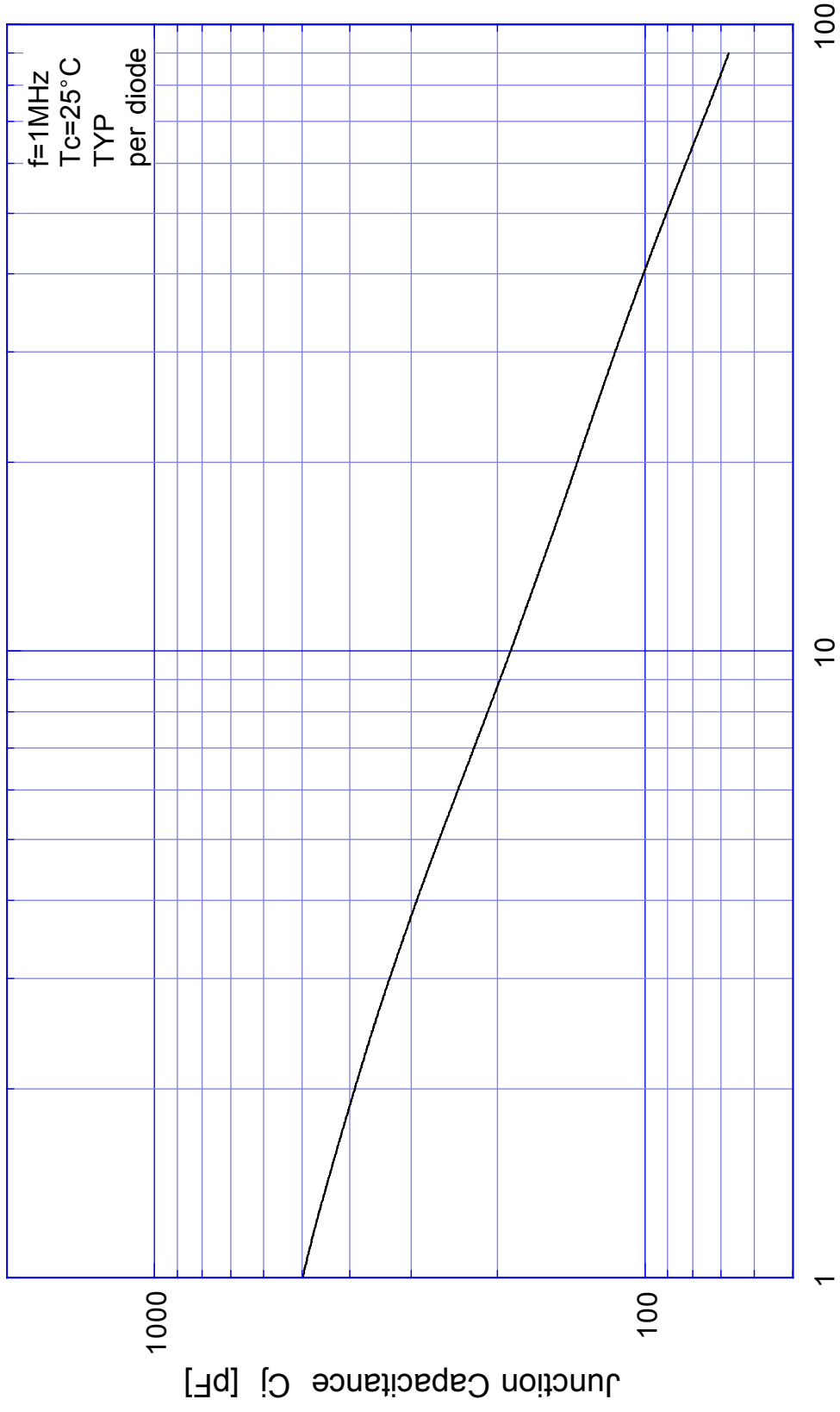

Reverse Voltage V_R [V]

DF10SC9 Reverse Current

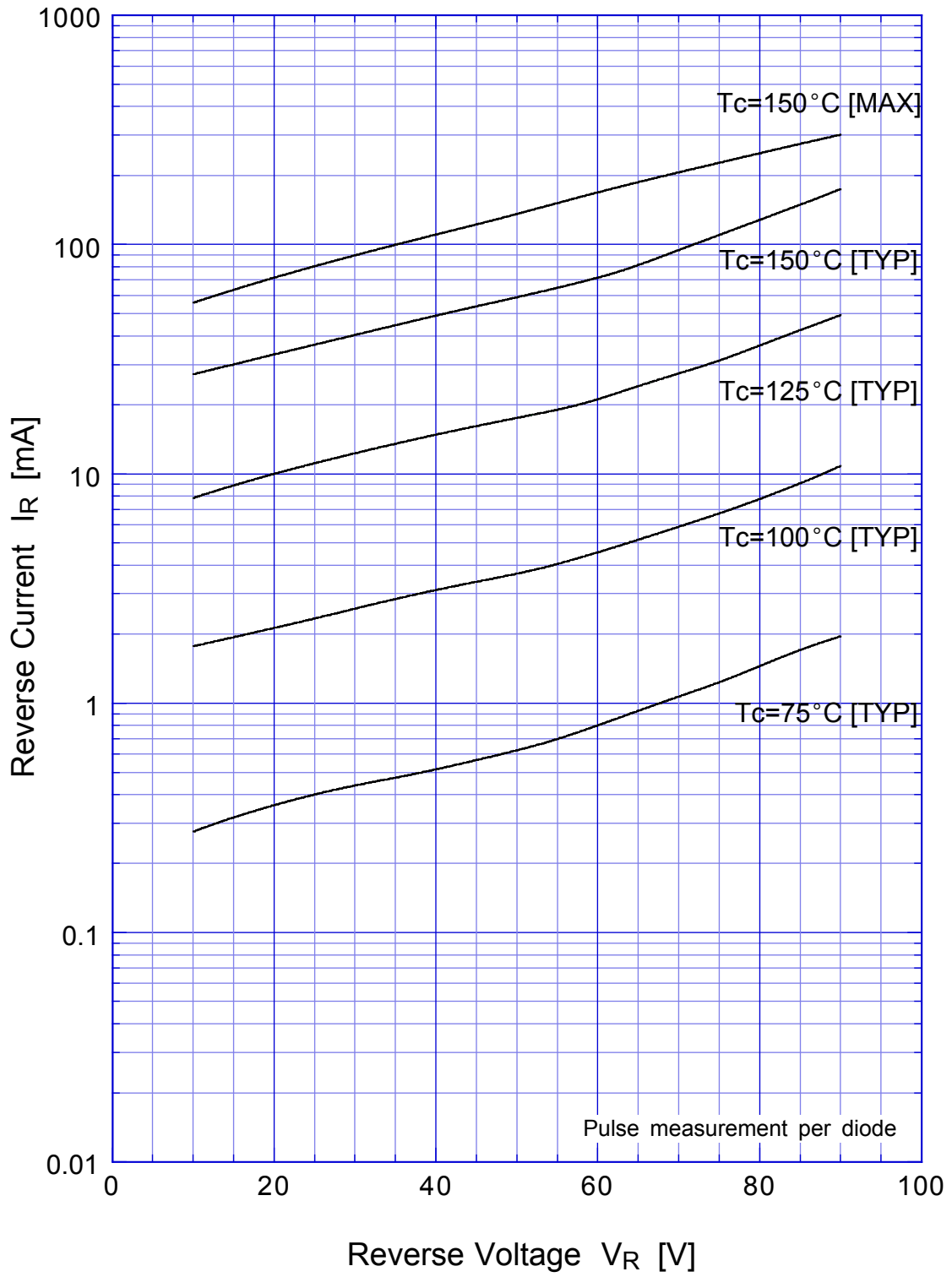

DF10SC9 Reverse Power Dissipation

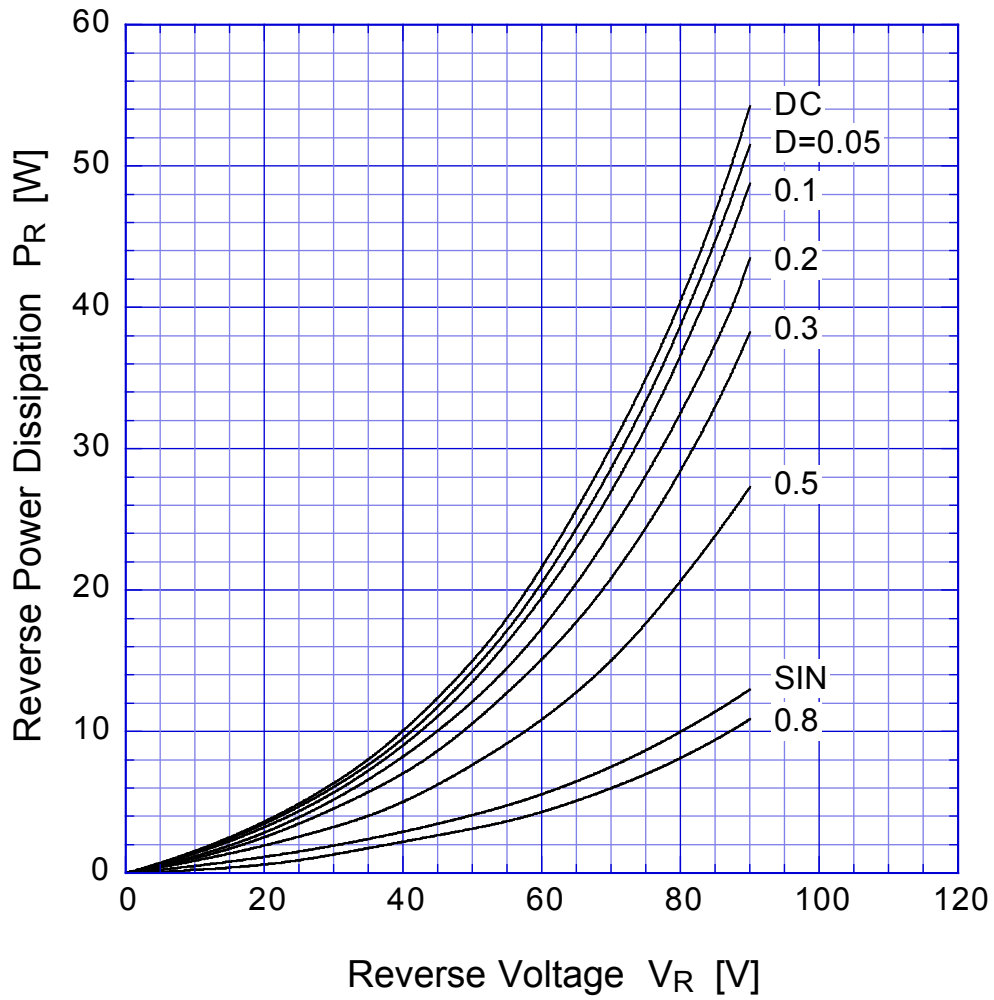

$T_j = 150^\circ\text{C}$

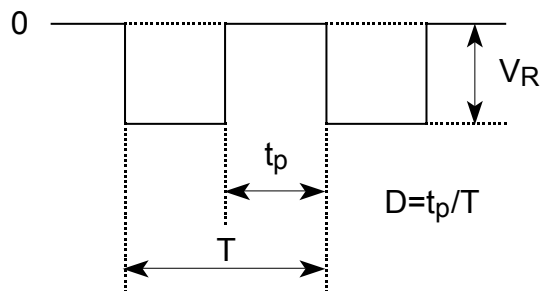

DF10SC9 Forward Power Dissipation

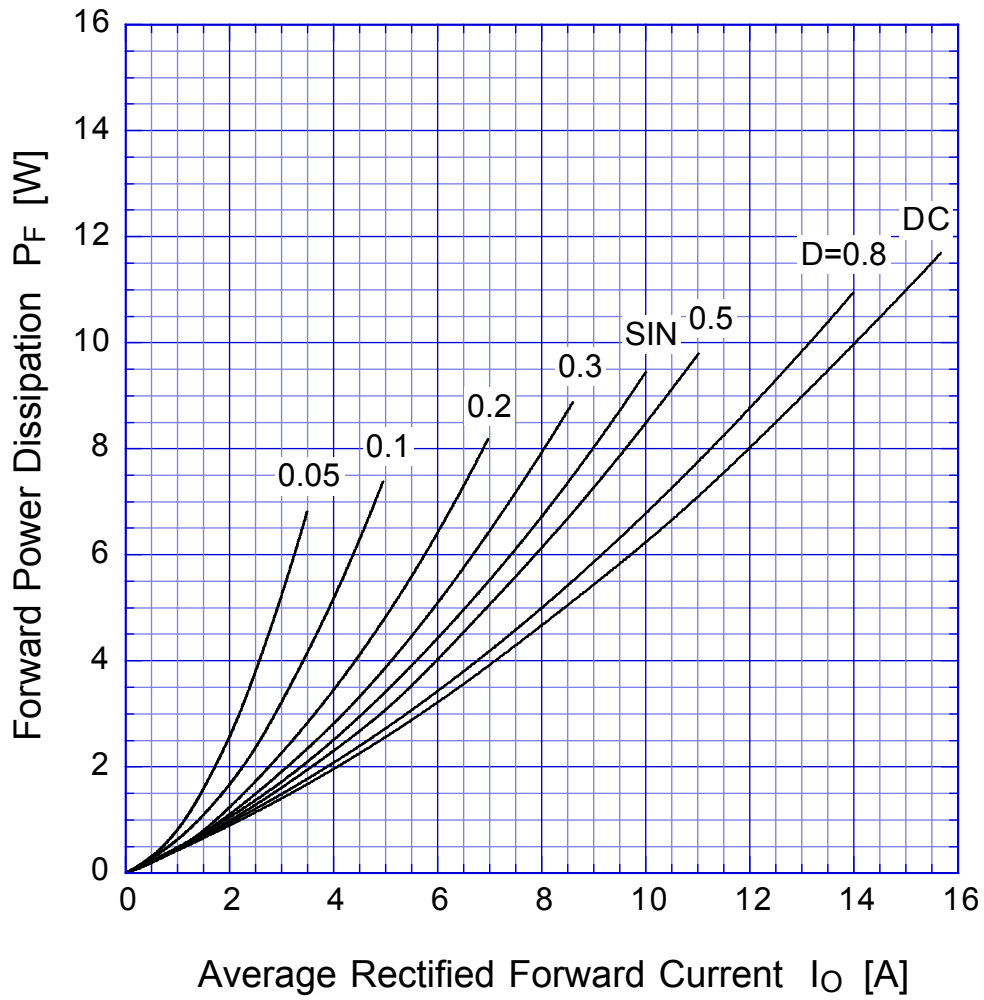

$T_j = 150^\circ\text{C}$

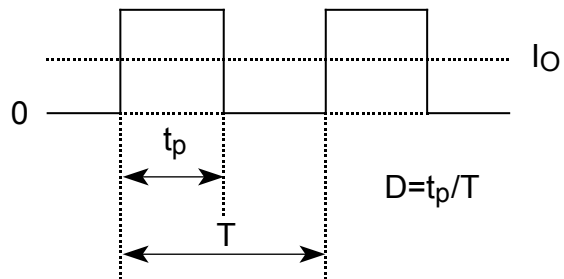

DF10SC9

Derating Curve

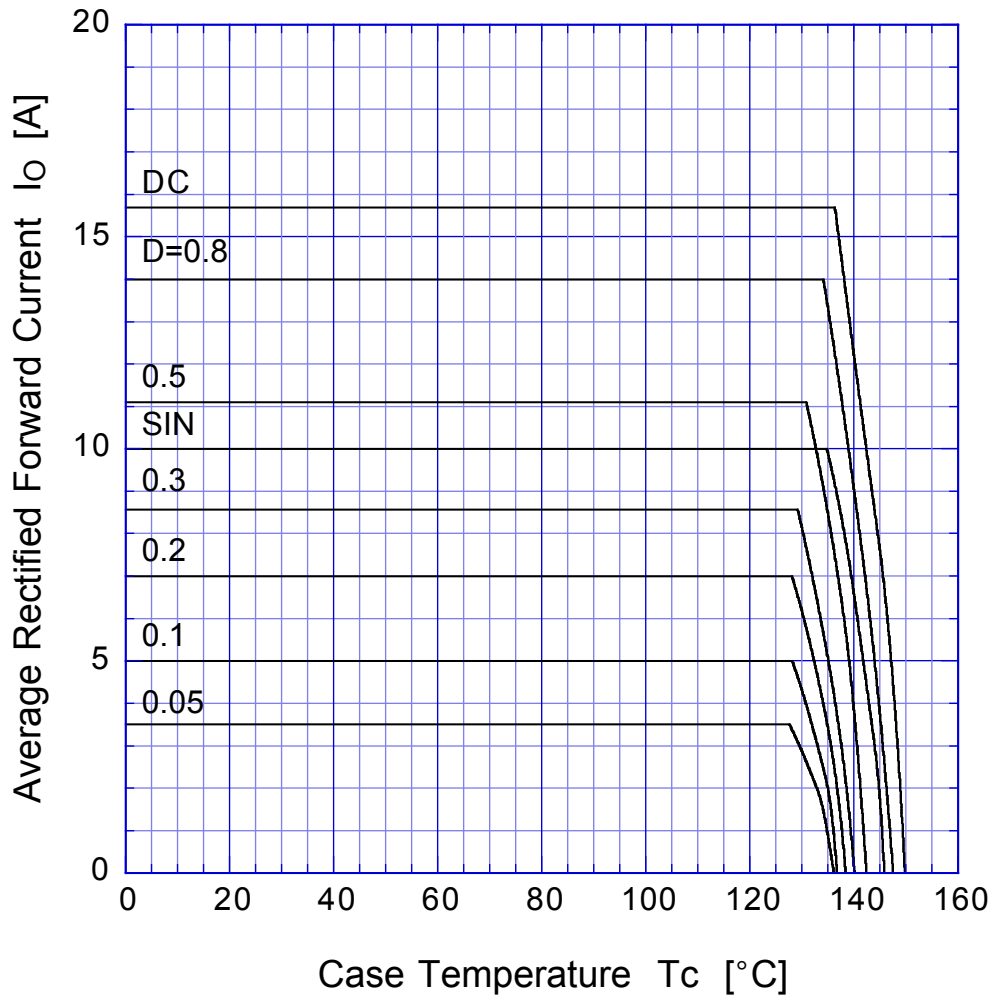

$V_R = 45V$

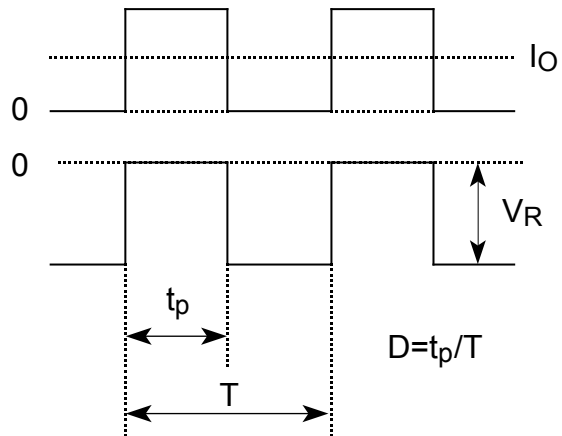

DF10SC9

Peak Surge Forward Capability

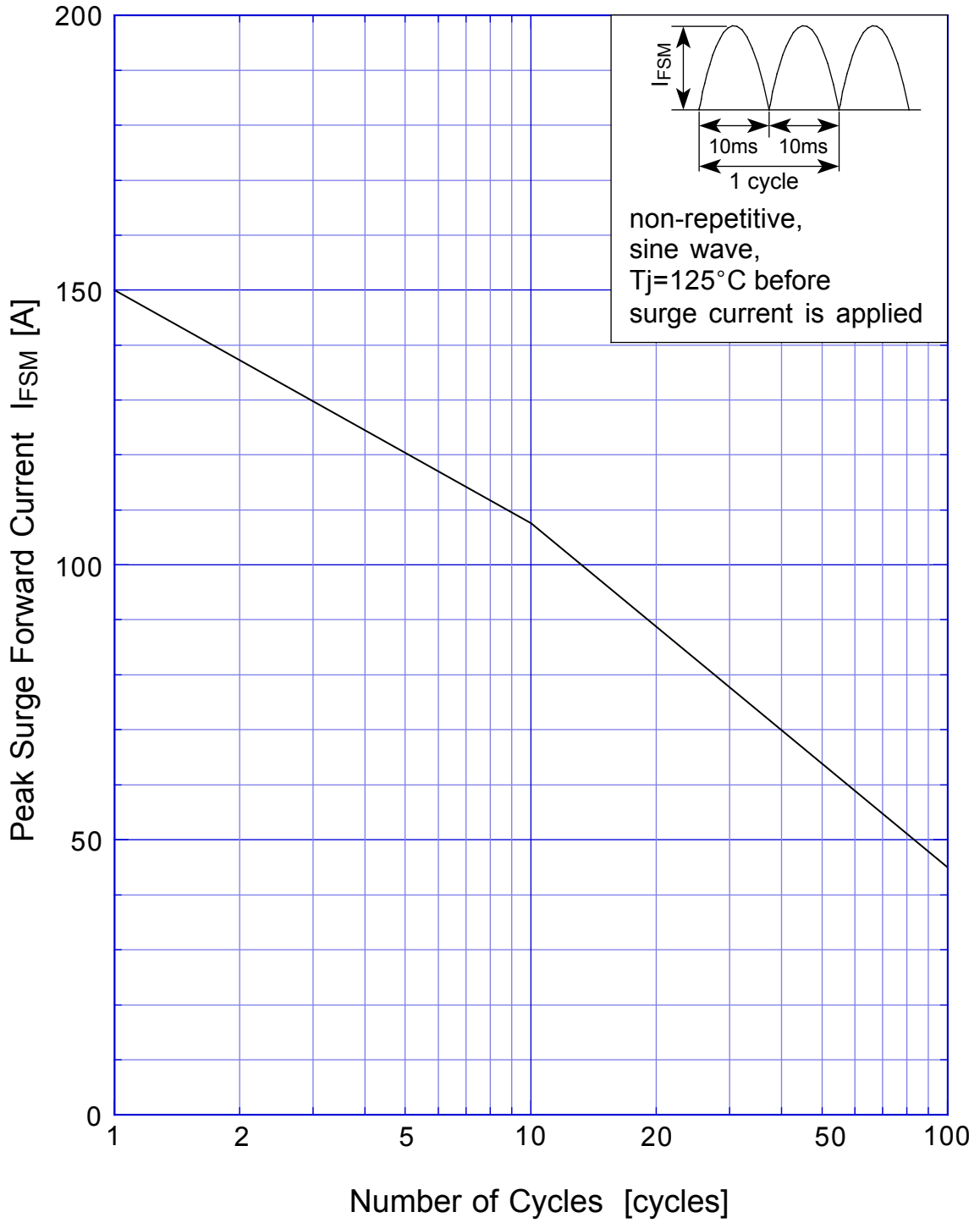

SBD Repetitive Surge Reverse Power Derating Curve

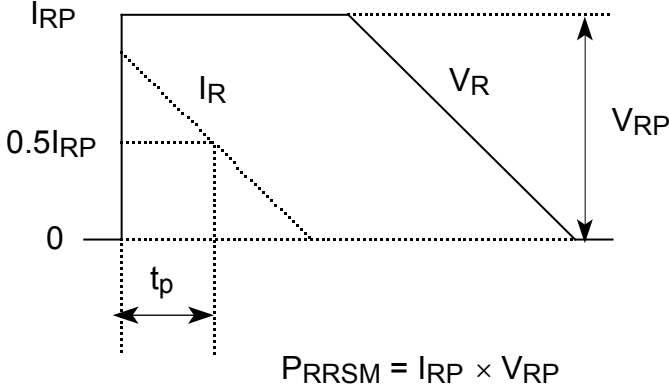
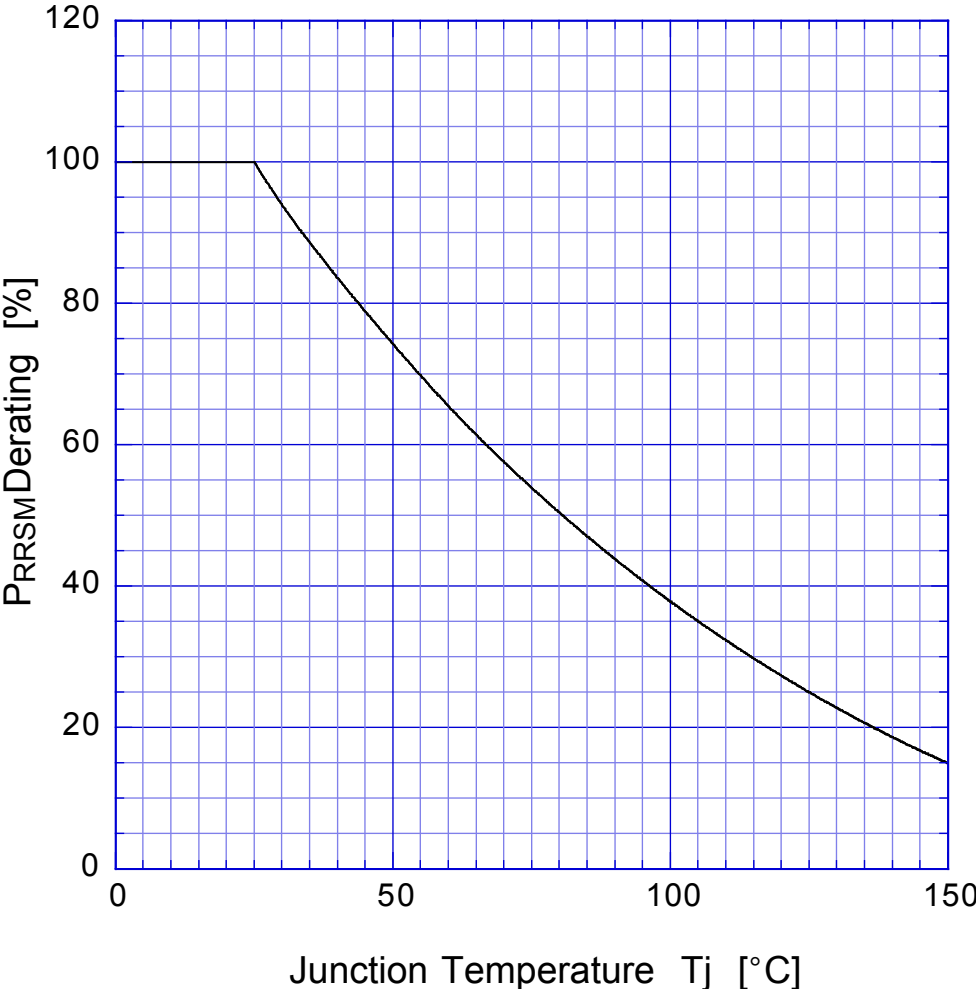

SBD

Repetitive Surge Reverse Power Capability

