

SHINDENGEN

Super Fast Recovery Rectifiers

Single

DF20L60

600V 20A

FEATURES

SMT
High Voltage
trr70ns

APPLICATION

PFC
Switching power supply
Free Wheel
Home Appliances, Office Equipment,
Factory Automation

OUTLINE DIMENSIONS

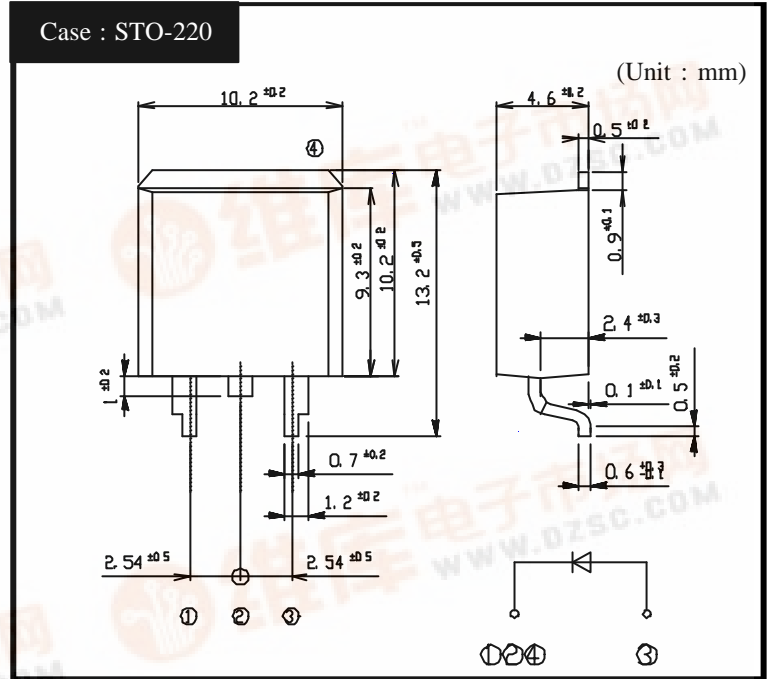

RATINGS

Absolute Maximum Ratings (If not specified Tc=25)

| Item | Symbol | Conditions | Ratings | Unit |
|-----------------------------------|------------------|--|-----------|------|
| Storage Temperature | Tstg | | -55 ~ 150 | |
| Operating Junction Temperature | Tj | | 150 | |
| Maximum Reverse Voltage | V _{RM} | | 600 | V |
| Average Rectified Forward Current | I _o | 50Hz sine wave, R-load, Tc=84 | 20 | A |
| Peak Surge Forward Current | I _{FSM} | 50Hz sine wave, Non-repetitive 1 cycle peak value, Tj=25 | 170 | A |

Electrical Characteristics (If not specified Tc=25)

| Item | Symbol | Conditions | Ratings | Unit |
|-----------------------|----------------|---|---------|------|
| Forward Voltage | V _F | I _F =20A, Pulse measurement | Max.1.9 | V |
| Reverse Current | I _R | V _R =V _{RM} , Pulse measurement | Max.25 | μA |
| Reverse Recovery Time | trr | I _F =0.5A, I _R =1A | Max.70 | ns |
| Thermal Resistance | jc | junction to case | Max.1.5 | /W |

DF20L60

Forward Voltage

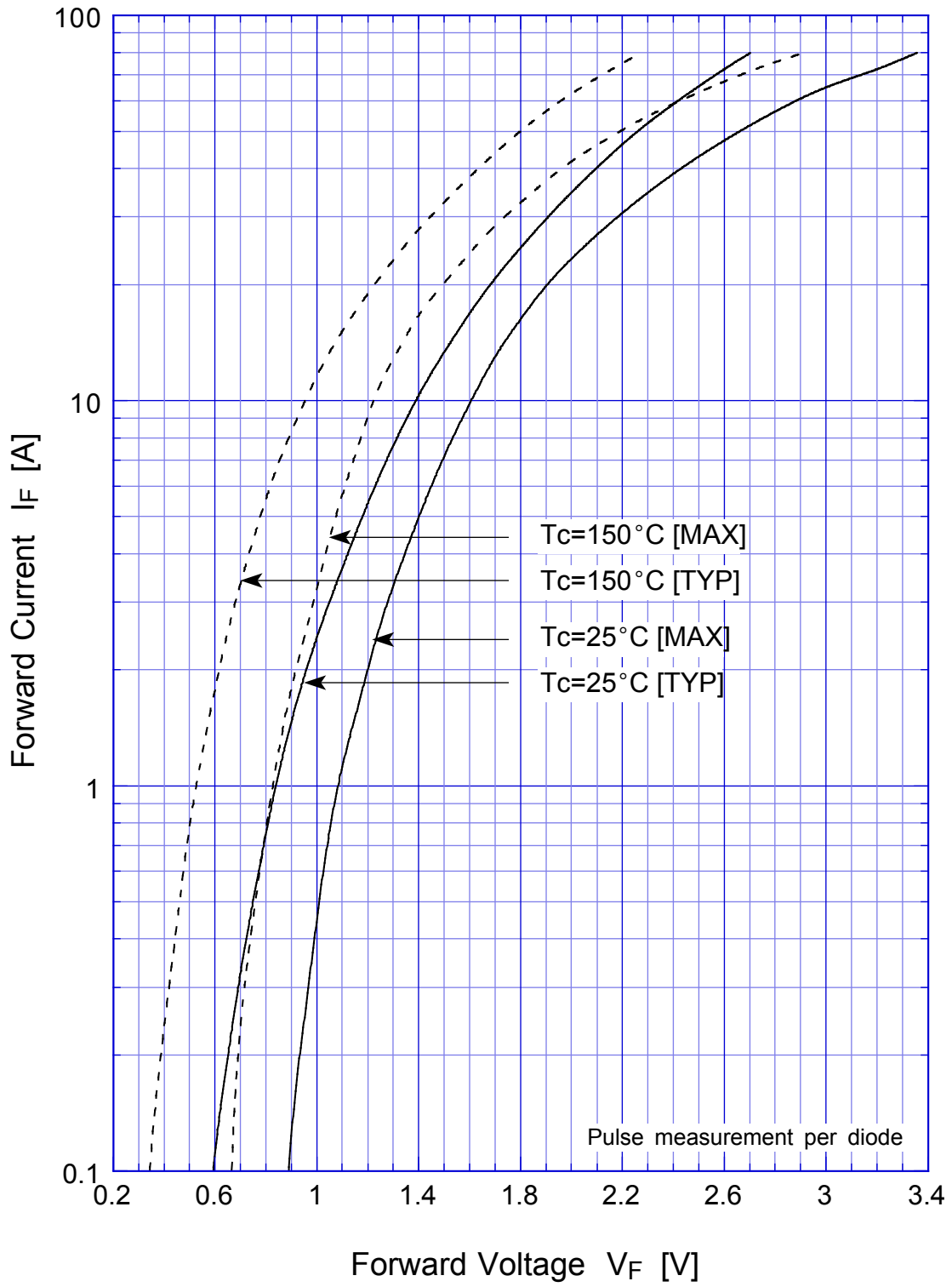

DF20L60 Forward Power Dissipation

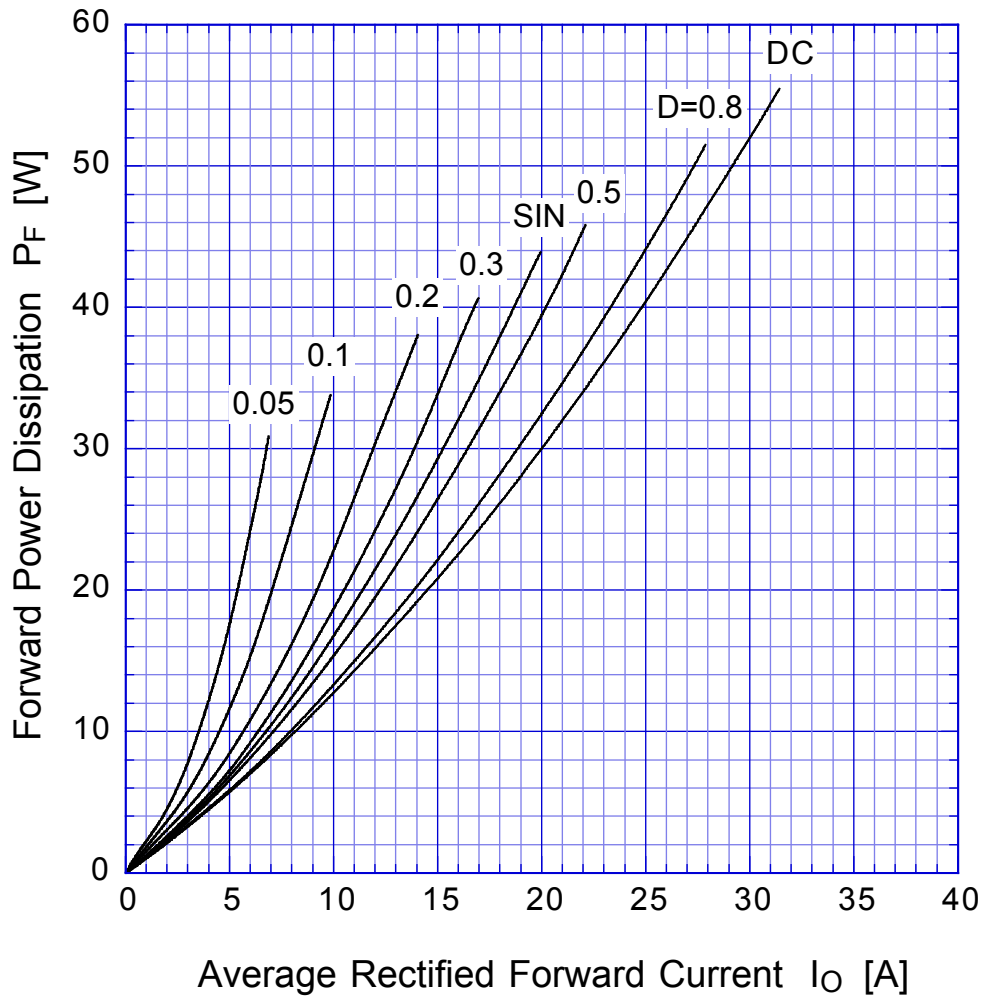

$T_j = T_{jmax}$

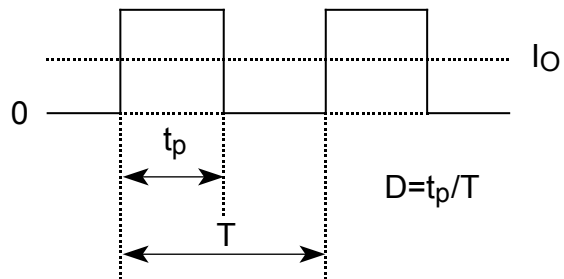

DF20L60

Derating Curve

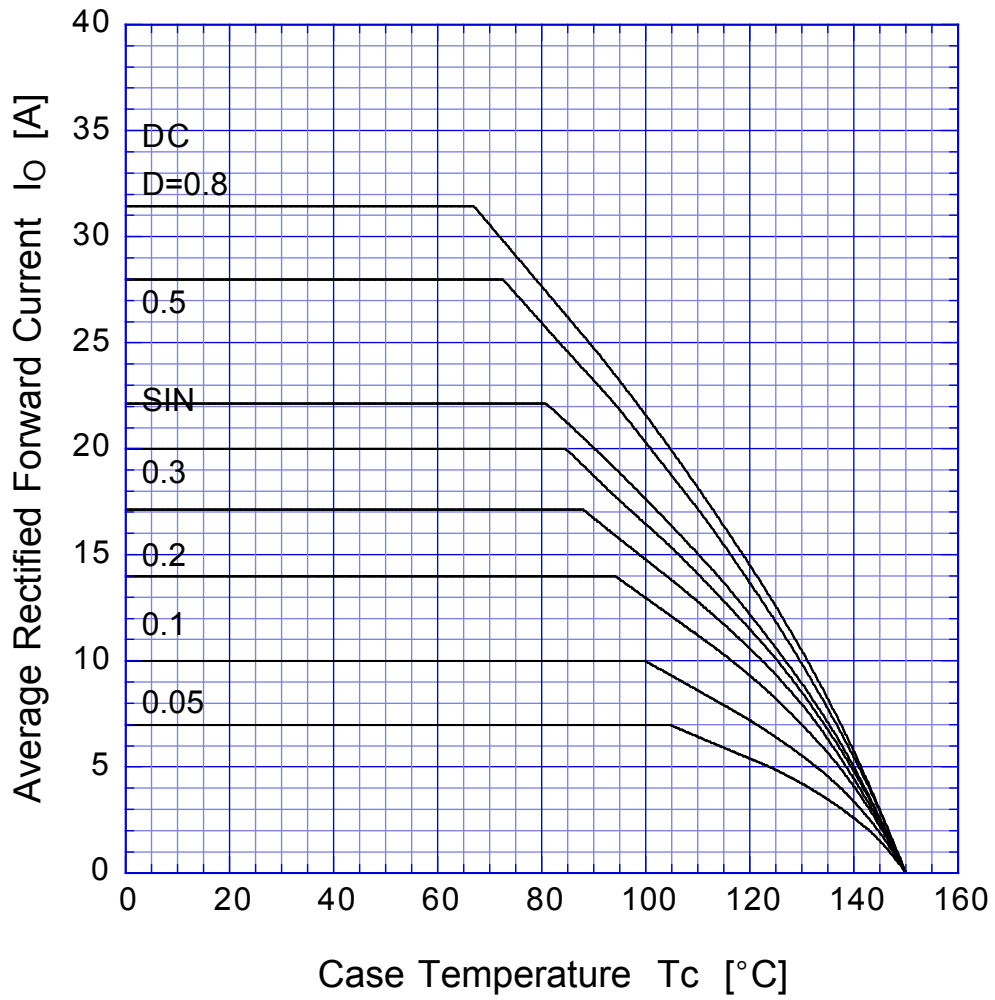

$$V_R = V_{RM}$$

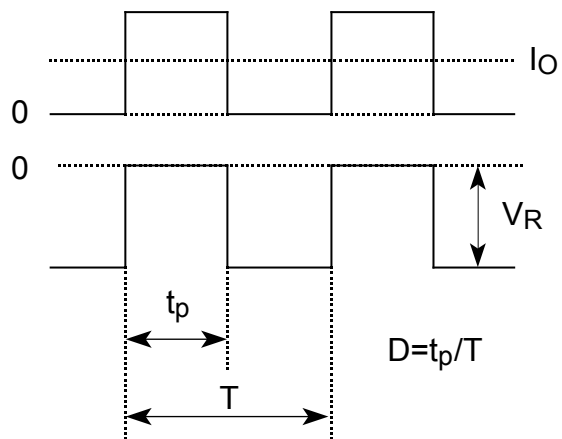

DF20L60

Peak Surge Forward Capability

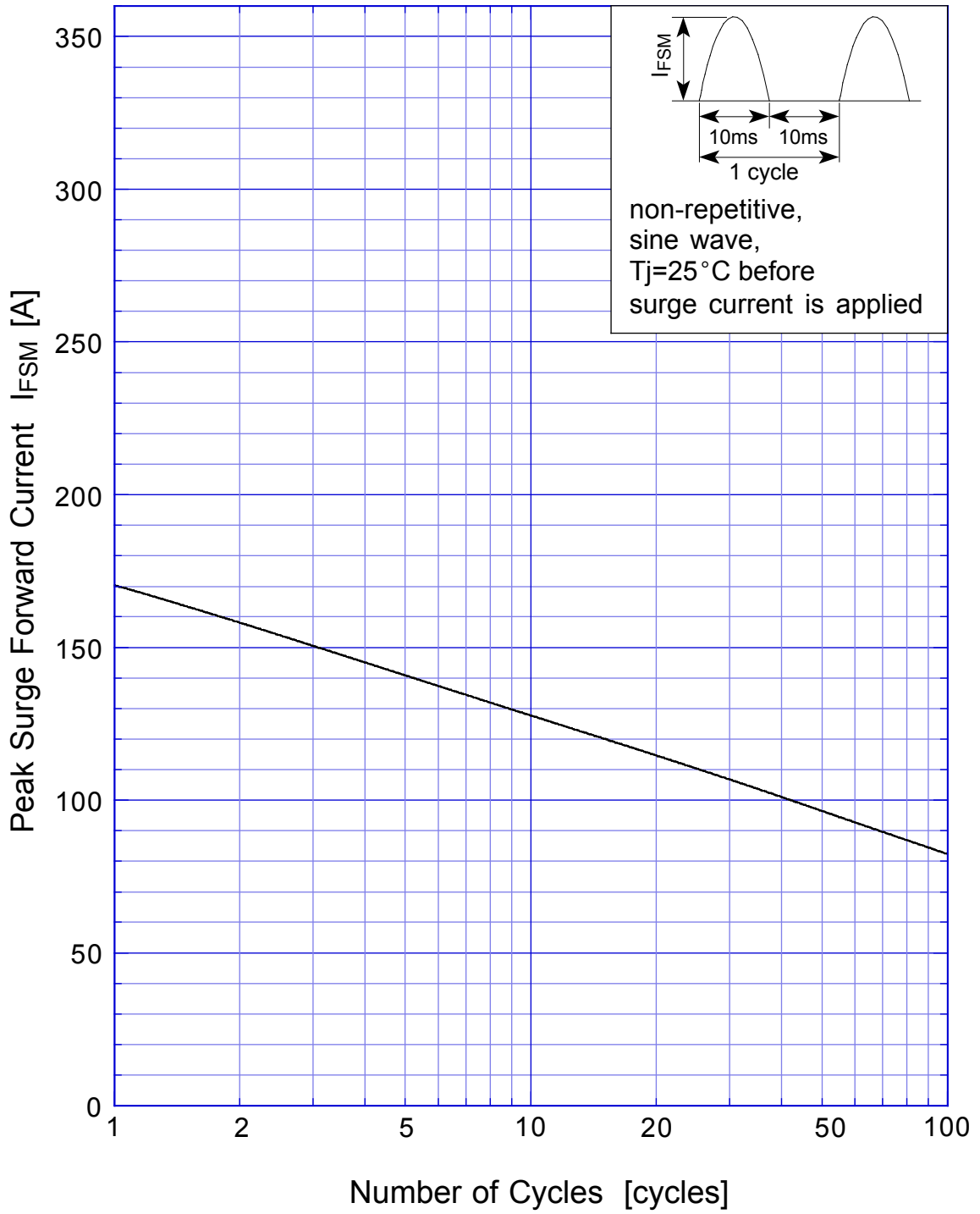

DF20L60 Junction Capacitance

