

SHINDENGEN

Schottky Rectifiers (SBD)

Dual

DF20SC9M

90V 20A

FEATURES

- SMT
- Tj150
- P_{RRSM} avalanche guaranteed
- High current capacity with Small Package

APPLICATION

- Switching power supply
- DC/DC converter
- Home Appliances, Office Equipment
- Telecommunication

OUTLINE DIMENSIONS

Case : STO-220

Unit : mm

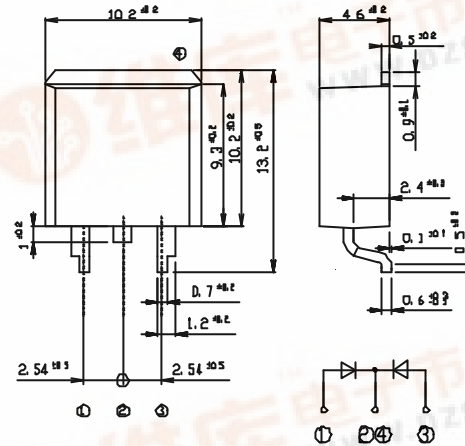

RATINGS

Absolute Maximum Ratings (If not specified Tc=25)

Item	Symbol	Conditions	Ratings	Unit
Storage Temperature	T _{stg}		-40 ~ 150	
Operating Junction Temperature	T _j		150	
Maximum Reverse Voltage	V _{RM}		90	V
Repetitive Peak Surge Reverse Voltage	V _{RRSM}	Pulse width 0.5ms, duty 1/40	100	V
Average Rectified Forward Current	I _O	50Hz sine wave, R-load, Rating for each diode I _O /2, Tc=111	20	A
Peak Surge Forward Current	I _{FSM}	50Hz sine wave, Non-repetitive 1 cycle peak value, Tj=25	200	A
Repetitive Peak Surge Reverse Power	P _{RRSM}	Pulse width 10 μs, Rating of per diode, Tj=25	660	W

Electrical Characteristics (If not specified Tc=25)

Item	Symbol	Conditions	Ratings	Unit
Forward Voltage	V _F	I _F =10A, Pulse measurement, Rating of per diode	Max.0.75	V
Reverse Current	I _R	V _R =V _{RM} , Pulse measurement, Rating of per diode	Max.10	mA
Junction Capacitance	C _j	f=1MHz, V _R =10V, Rating of per diode	Typ.370	pF
Thermal Resistance	θ _{JC}	junction to case	Max.1.6	/W



DF20SC9M Forward Voltage

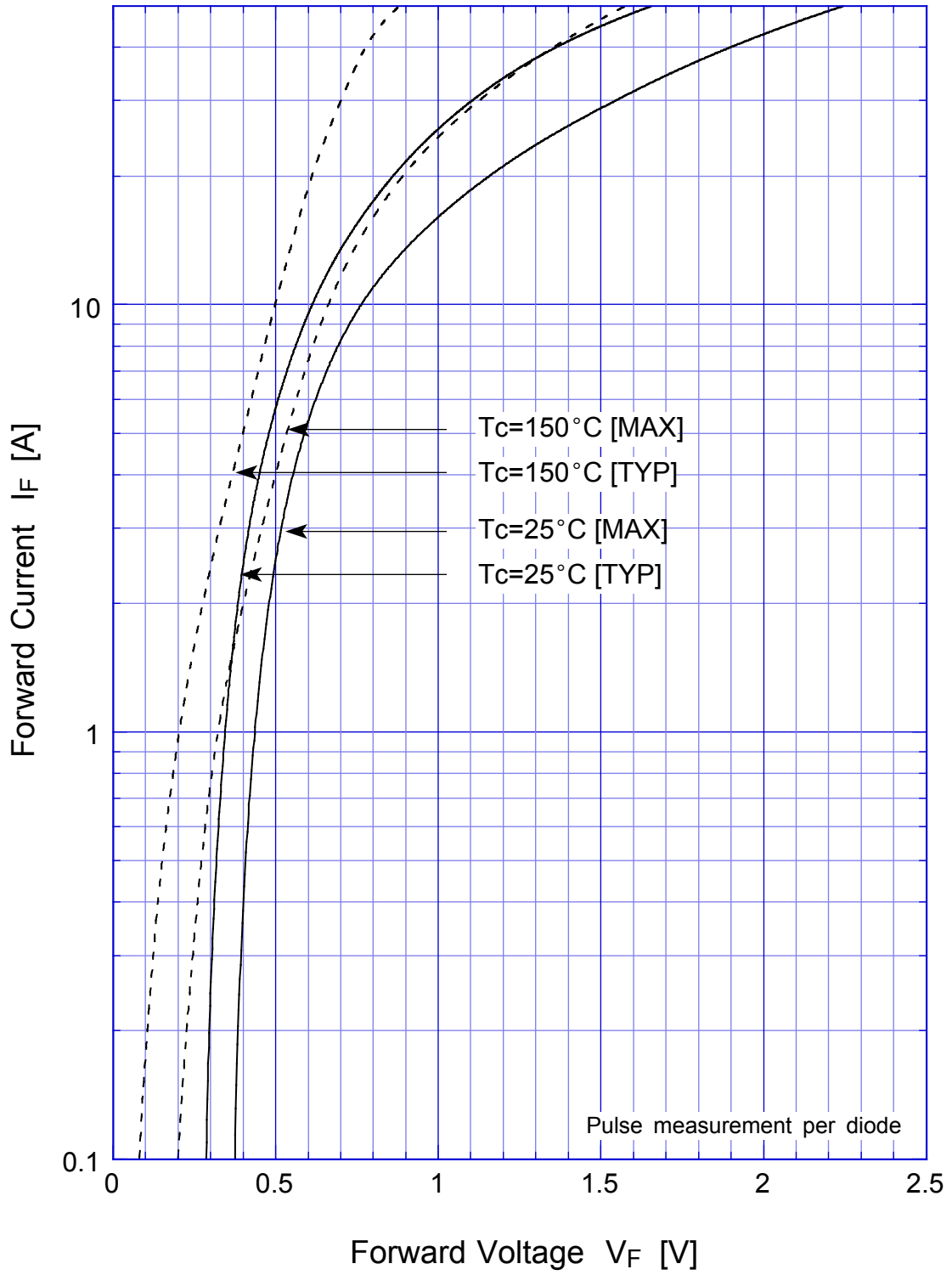

DF20SC9M Junction Capacitance

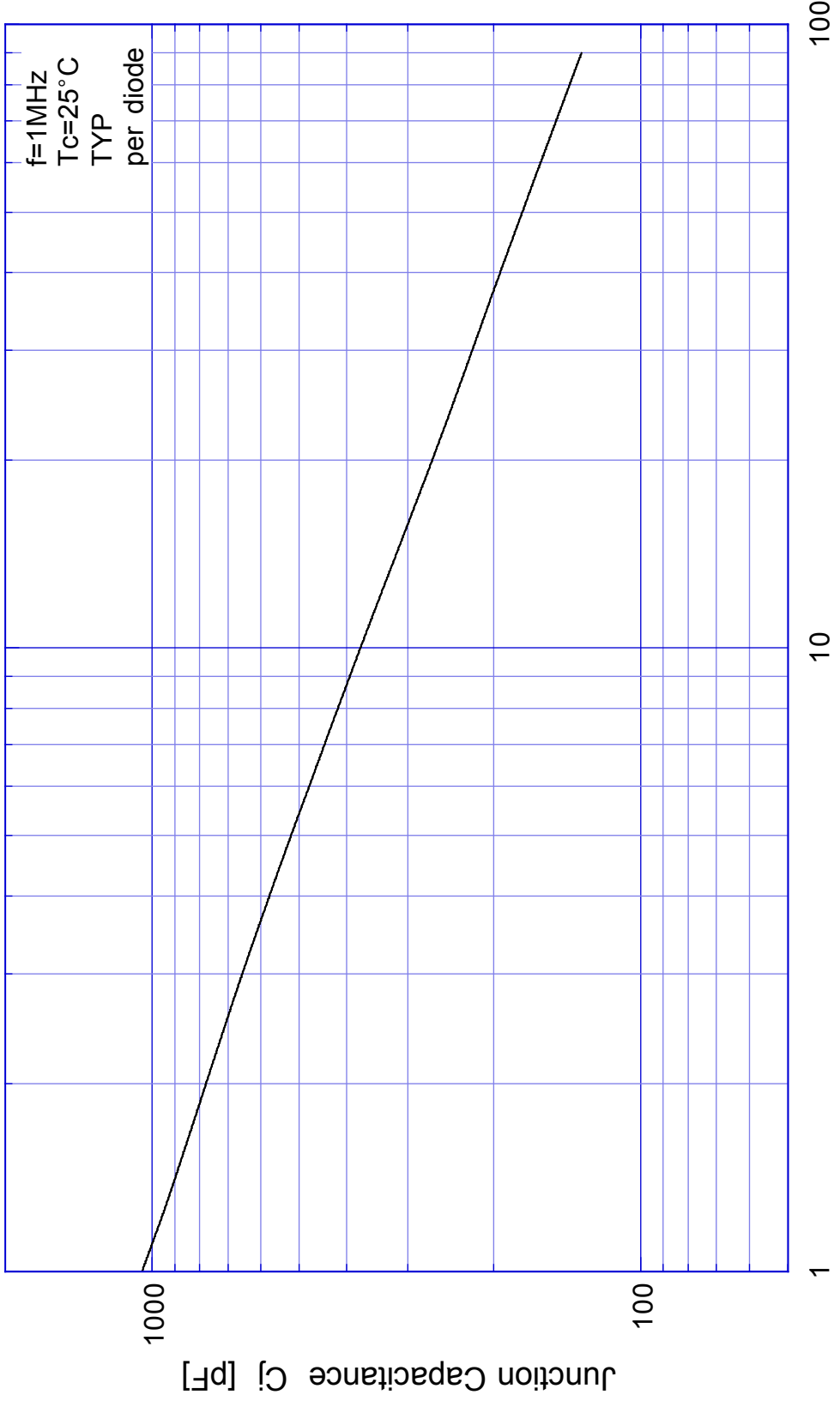

DF20SC9M Reverse Current

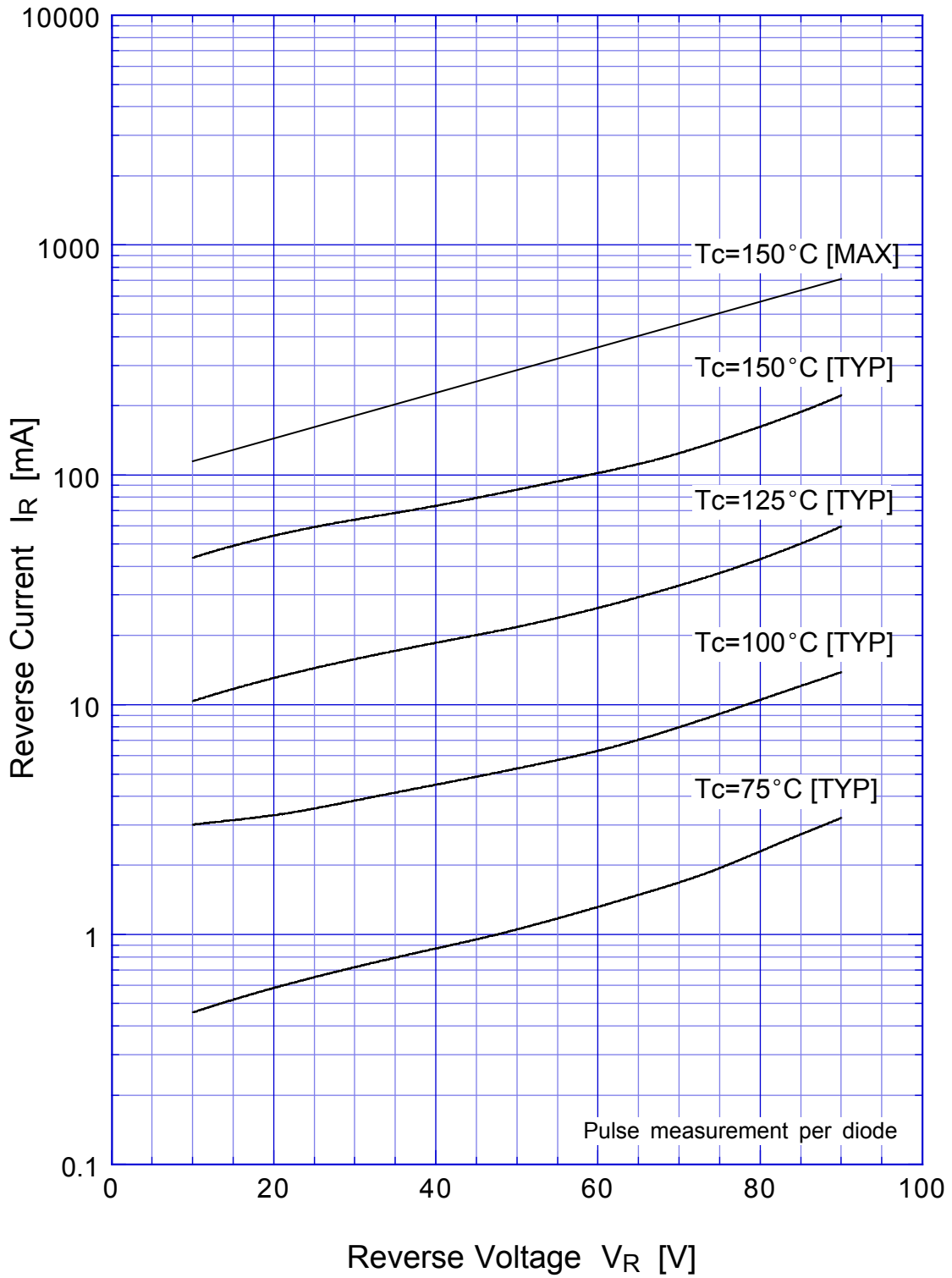

DF20SC9M Reverse Power Dissipation

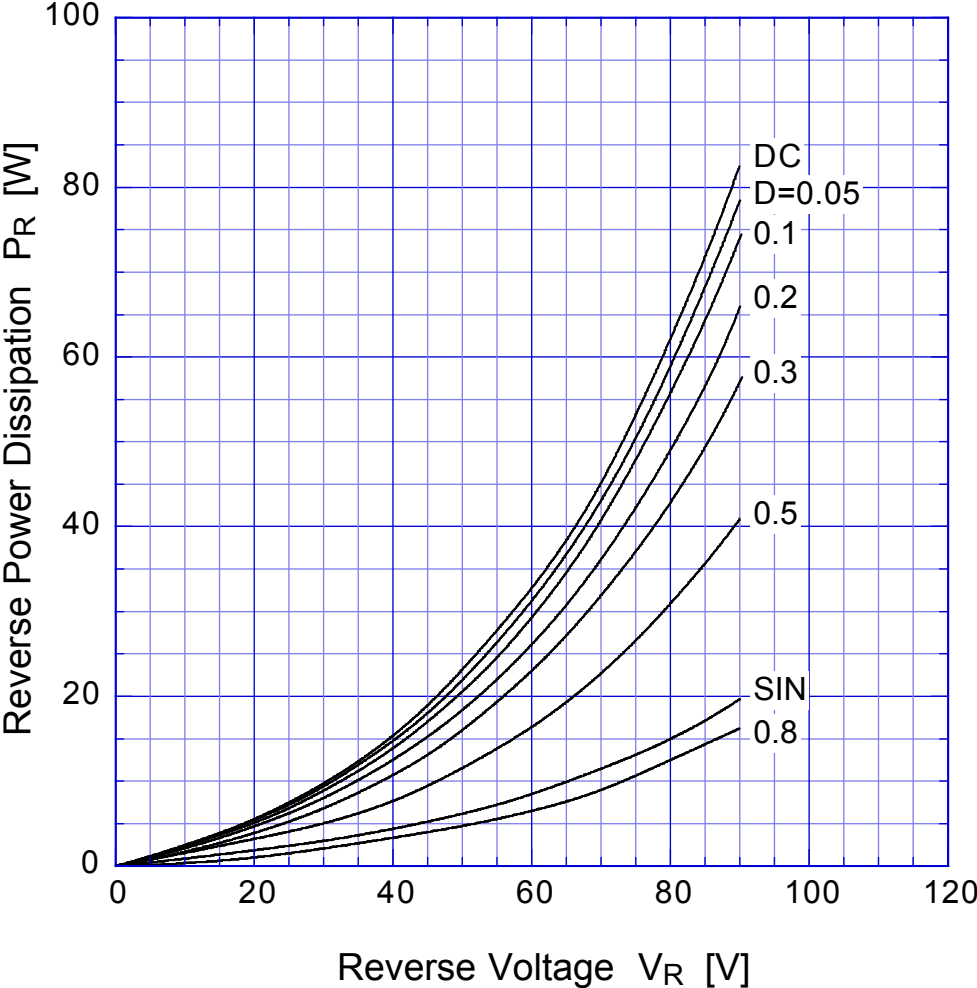

$T_j = 150^\circ\text{C}$

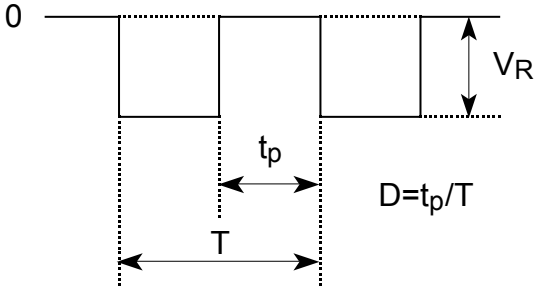

DF20SC9M Forward Power Dissipation

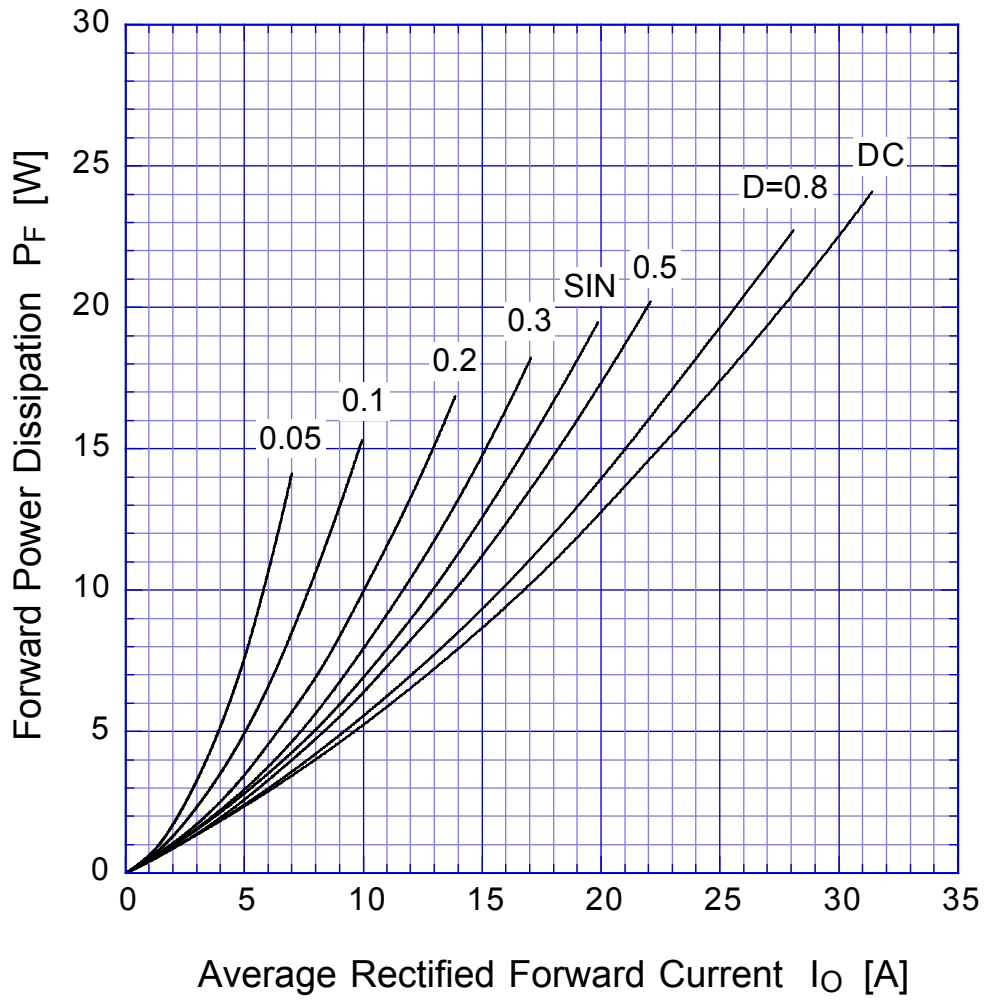

$T_j = 150^\circ\text{C}$

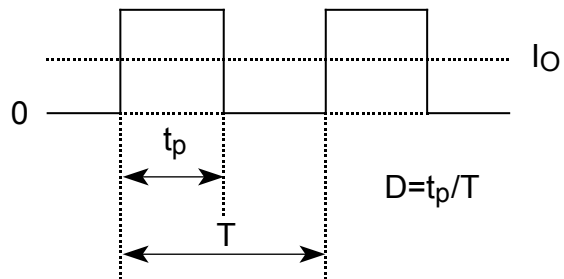

DF20SC9M

Derating Curve

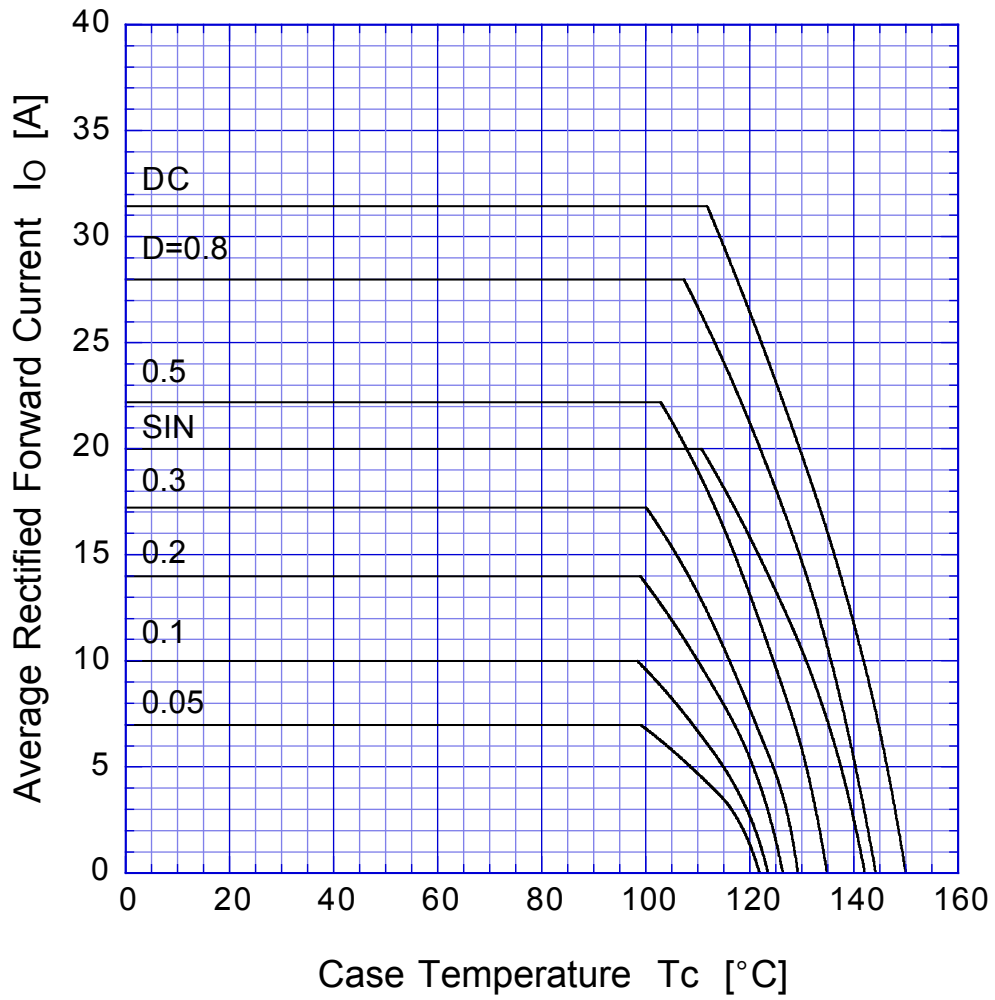

$V_R = 45V$

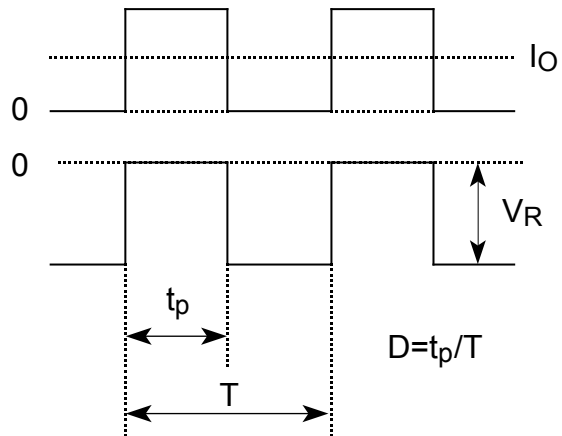

DF20SC9M Peak Surge Forward Capability

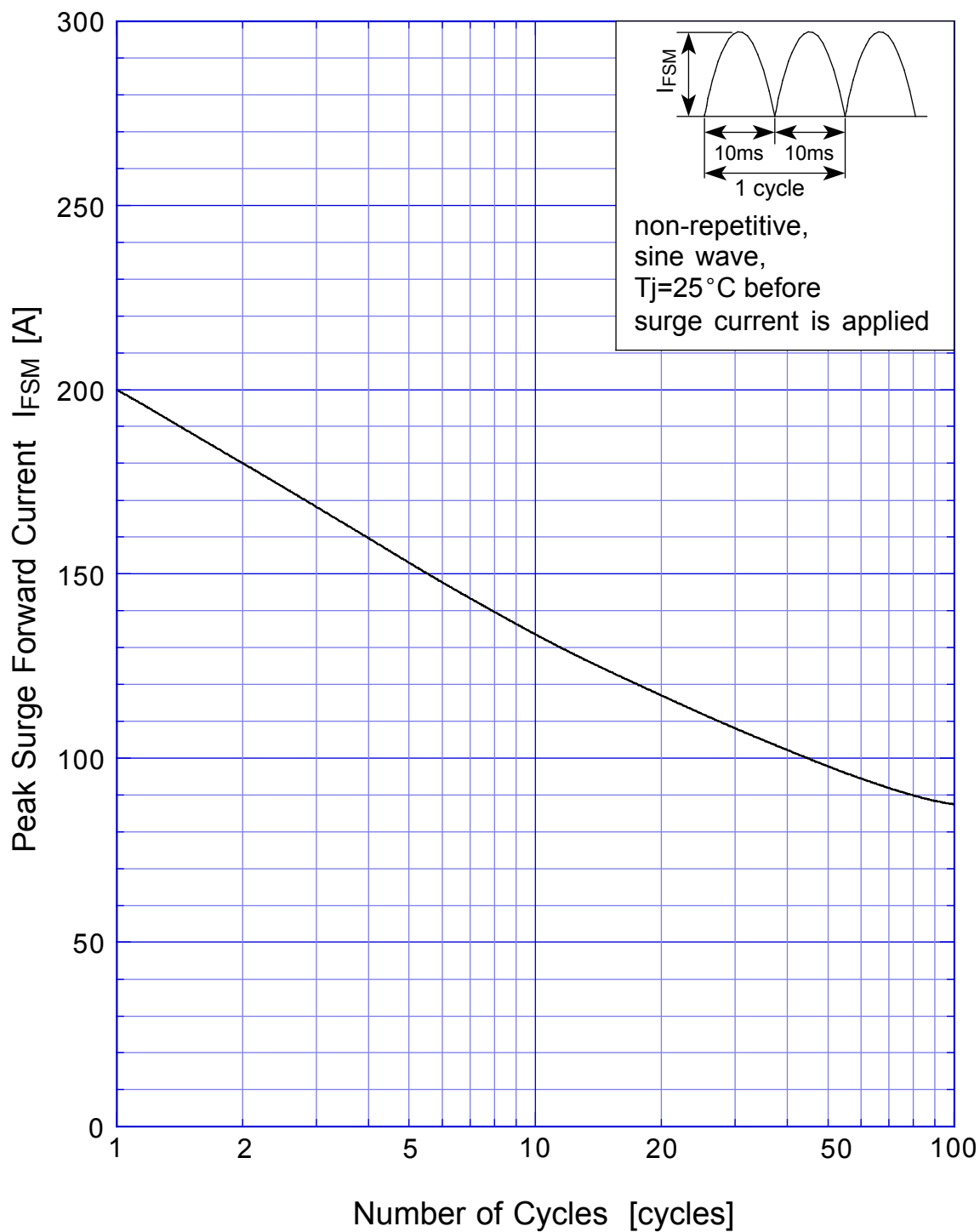

SBD Repetitive Surge Reverse Power Derating Curve

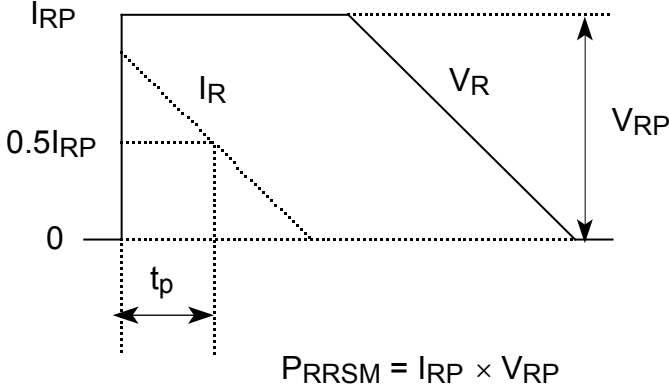
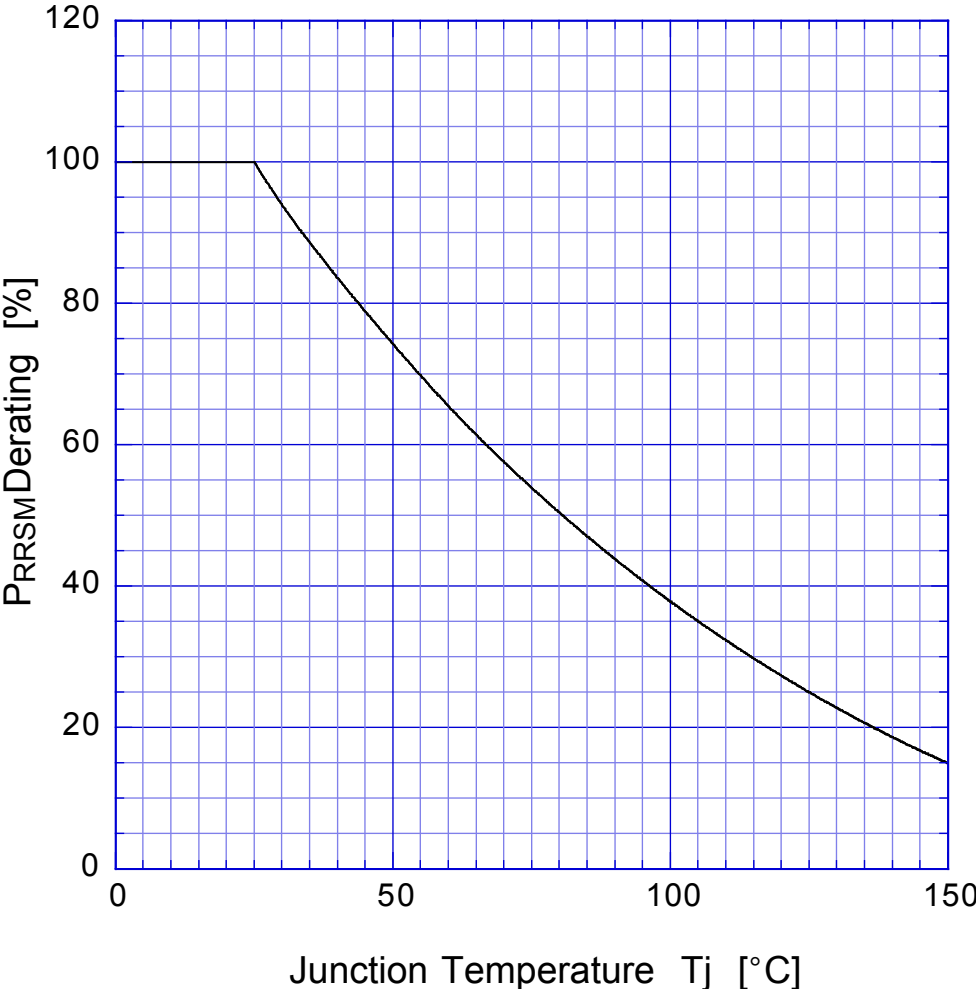

SBD

Repetitive Surge Reverse Power Capability

