

SIEMENS

HIGH EFFICIENCY RED DLO4135/7135

GREEN DLG4137/7137

.43" Single Character DLO4135/7

.68" Single Character DLO7135/7

5x7 Dot Matrix Intelligent Display[®] with Memory/Decoder/Driver

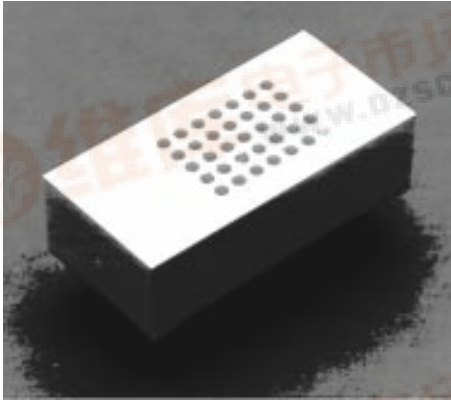

DLO4135/4137



DLO7135/7137

Package Dimensions in Inches (mm)

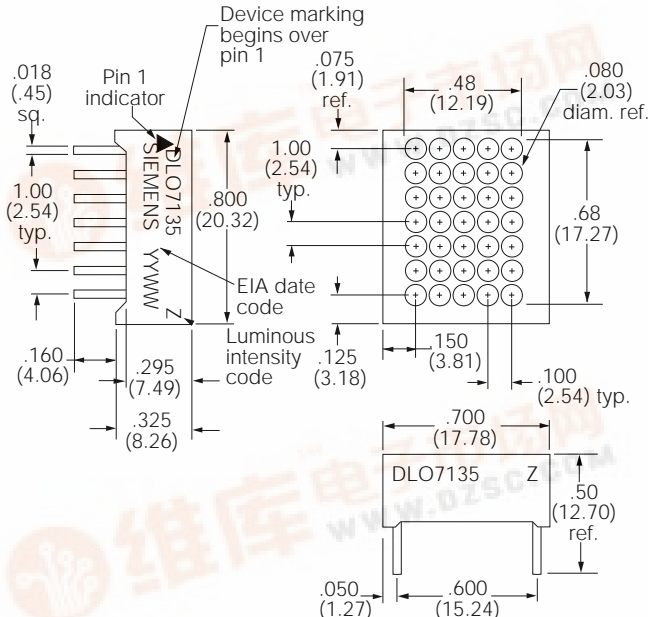
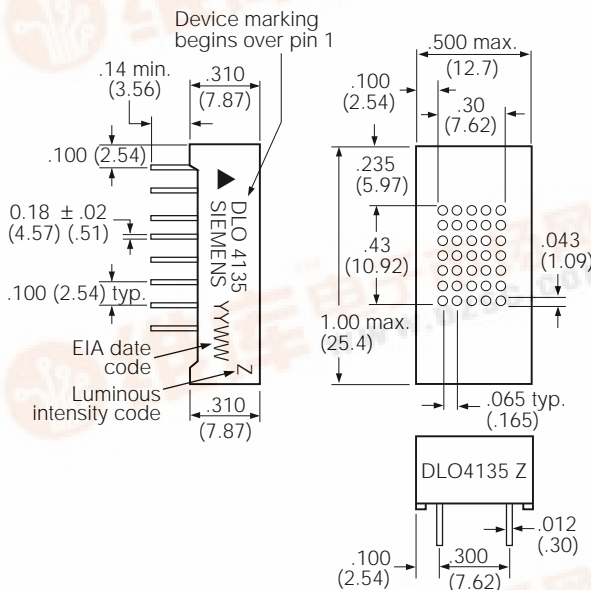

FEATURES

- **5x7 Dot Matrix Characters**
DLO4135/DLG4137: .43" High
DLO7135/DLG7137: .68" High
- **Wide Viewing Angle ±75°**
- **96 Character ASCII Set**
Upper Case and Lower Case Characters
- **Fully Encapsulated, Rugged Solid Plastic Package**
- **Built-in Memory**
- **Built-in Character Generator**
- **Built-in Multiplex and LED Drive Circuitry**
- **Built-in Lamp Test**
- **Intensity Control (4 levels)**
- **Microprocessor Bus Compatible**
- **Intensity Coded for Display Uniformity**
- **Single 5-Volt Power Supply**
- **X/Y Stackable**
- **Available in High Efficiency Red and Green**



DESCRIPTION

The DLX413X/DLX713X are single digit 5x7 dot matrix Intelligent Display devices. The DLX413X character is 0.43" high. The DLX713X character is 0.68" high. The built-in CMOS integrated circuit contains memory, ASCII character generator, LED multiplexing and drive circuitry; thereby eliminating the need for additional circuitry. They will display the 96 ASCII characters.

These devices are TTL and microprocessor compatible and offer the possibility of cascading the displays, allowing for multi-character messages. These displays were designed for viewing distances of up to 20 feet (DLX413X) or 30 feet (DLX713X). They require a single 5-volt power supply and parallel ASCII input.

All products are 100% tested, then subjected to out-going AQLs of .25% for brightness matching, visual alignment and dimensions, .065% for electrical and functional.

Important: Refer to Appnote 18, "Using and Handling Intelligent Displays." Since this is a CMOS device, normal precautions should be taken to avoid static damage.

Timing Parameters at 25°C, $V_{CC}=5.0\text{ V} \pm 0.5\text{ V}$

Symbol	Parameter	Units (ns)
T_{CES}	Chip Enable Set-Up	10
T_{DS}	Data Set Up	100
T_W	Write Pulse	120
T_{DH}	Data Hold	20
T_{CEH}	Chip Enable Hold	20
T_{ACC}	Access Time	150

DC Characteristics

Parameter	-40°C			+25°C			+85°C			Units	Conditions
	Min.	Typ.	Max.	Min.	Typ.	Max.	Min.	Typ.	Max.		
I_{CC} (20 dots on)		135	180		100	140		85	115	mA	$V_{CC}=5\text{ V}$, $\overline{BL0}=\overline{BL1}=5\text{ V}$
I_{CC} Blank		2.0	5.5		1.5	4.0		0.8	3.5	mA	$V_{CC}=\overline{WR}=5.0\text{ V}$, $\overline{BL0}=\overline{BL1}=0\text{ V}$
I_{IL} (all inputs)				25	50	100				μA	$V_{IN}=0.8\text{ V}$, $V_{CC}=5\text{ V} \pm 0.5\text{ V}$
V_{IH}	2.0			2.0			2.0			V	$V_{CC}=5\text{ V} \pm 0.5\text{ V}$
V_{IL}			0.8			0.8			0.8	V	$V_{CC}=5\text{ V} \pm 0.5\text{ V}$
V_{CC}	4.5	5.0	5.5	4.5	5.0	5.5	4.5	5.0	5.5	V	

Notes

- "Off Axis Viewing Angle" definition: The minimum angle in any direction from the normal to the display surface at which any part of any dot in the display is not visible.
- This display contains a CMOS integrated circuit. Normal CMOS handling precautions should be taken to avoid damage due to high static voltages or electric fields. See Appnote 18.**
- Unused inputs must be tied to an appropriate logic voltage level (either V+ or GND).
- $V_{CC}=5.0\text{ VDC} \pm 10\%$.
- Clean only in water, isopropyl alcohol, freon TF, TE (or equivalent).

Maximum Ratings

V_{CC} Range (max.) -0.5 to +7.0 Vdc
 Voltage, Any Pin, Respect to GND -0.5 to $V_{CC} + 0.5\text{ Vdc}$
 Operating Temperature -40°C to +85°C
 Storage Temperature -40°C to +100°C
 Maximum Solder Temperature, .063"
 below Seating Plane, $t < 5\text{ sec.}$ 260°C
 Relative Humidity at 85°C (non condensing) 85%

Optical Characteristics (Typical) at 25°C

Time Averaged Luminous Intensity/Dot at 5 V . . . 1500 mcd typ.
 Character Size
 DLO4135/DLG4137 0.43"
 DLO7135/DLG7137 0.68"
 Viewing Angle (Note 1) $\pm 75^\circ$
 Spectral Peak Wavelength
 DLO4135/7135 (High Efficiency Red) 635 nm typ.
 DLG4137/7137 (Green) 565 nm typ.
 Dot to Dot Intensity Ratio 1.8:1.0 max.

Timing Characteristics — Write Cycle Waveforms

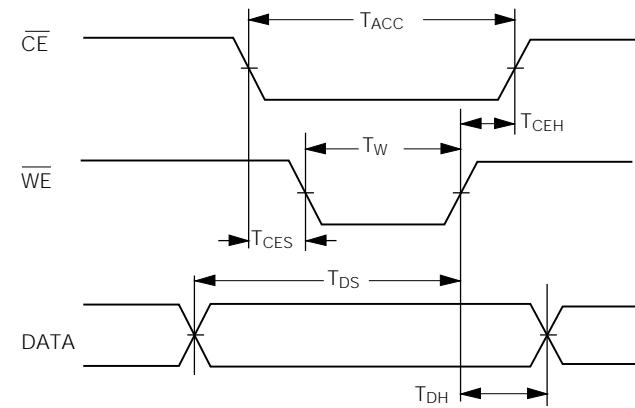

Top View — DLO4135/DLG4137

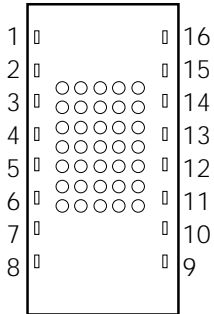

Pin Functions — DLO4135/DLG4137

Pin	Function	Pin	Function
1	\overline{LT} Lamp	9	D0 Data LSB
2	\overline{WR} Write	10	D1 Data
3	$\overline{BL1}$ Brightness	11	D2 Data
4	$\overline{BL0}$ Brightness	12	D3 Data
5	No Pin	13	D4 Data
6	No Pin	14	D5 Data
7	\overline{CE} Chip Enable	15	D6 Data MSB
8	GND	16	+V _{CC}

Top View — DLO7135/DLG7137

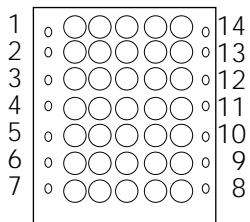

Pin Functions — DLO7135/DLG7137

Pin	Function	Pin	Function
1	V _{CC}	8	D0 Data Input LSB
2	\overline{LT} Lamp Test	9	D1 Data
3	\overline{CE} Chip Enable	10	D2 Data
4	\overline{WR} Write	11	D3 Data
5	$\overline{BL1}$ Brightness	12	D4 Data
6	$\overline{BL0}$ Brightness	13	D5 Data
7	GND	14	D6 Data Input MSB

Lamp Test

When the lamp test (\overline{LT}) is activated, all dots on the display are illuminated at $1/7$ brightness. The lamp test function is independent of write (\overline{WR}) and the settings of the blanking inputs ($\overline{BL0}$, $\overline{BL1}$).

This convenient test gives a visual indication that all dots are functioning properly. Lamp test also may be used as a cursor function or pointer which does not destroy previously displayed characters.

Dimming and Blanking the Display

Brightness Level	$\overline{BL1}$	$\overline{BL0}$
Blank	0	0
$1/7$ Brightness	0	1
$1/2$ Brightness	1	0
Full Brightness	1	1

Loading Data

Loading data into the display is straightforward. Chip enable (\overline{CE}) should be present and stable during a write pulse (\overline{WR}). Parallel data information should be stable for the minimum time (T_{W}) and held for TDH after write has gone high. No synchronization is necessary and each character will continue to be displayed until it is replaced with another. Multiple displays may be stacked together with only an additional decoder IC for chip enable decoding.

Note : Either $\overline{BL0}$ or $\overline{BL1}$ should be held high for display to light up.

Data Loading Example

\overline{CE}	\overline{WR}	$\overline{BL0}$	$\overline{BL1}$	\overline{LT}	Data Input								
					D6	D5	D4	D3	D2	D1	D0		
H	X	H	X	H	X	X	X	X	X	X	X	X	NC
X	X	L	L	H	X	X	X	X	X	X	X	X	Blank
X	X	X	X	L	X	X	X	X	X	X	X	X	Lamp Test
L	L	H	H	H	H	L	L	L	L	L	H	A	
L	L	H	H	H	H	H	H	L	L	H	L	r	
L	L	H	H	H	L	H	H	L	L	H	H	3	
L	L	H	H	H	L	H	L	H	L	H	H	+	

X=don't care, NC=no change

16 Digits Interconnection

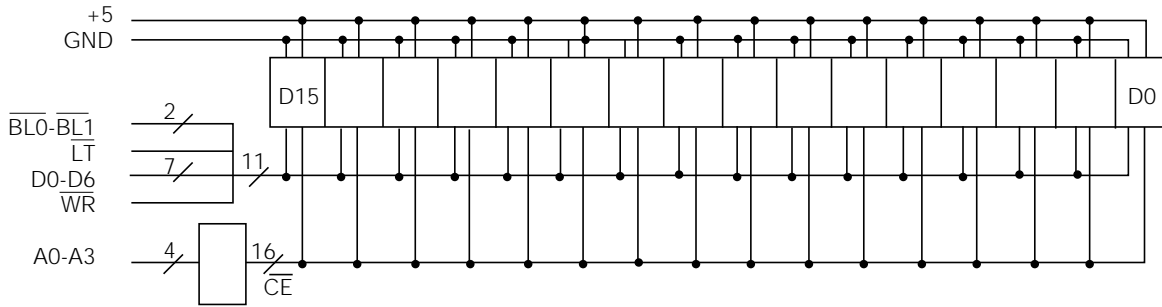

Character Set

ASCII CODE				D0	D1	D2	D3	D4	D5	D6	D7	D8	D9	D10	D11	D12	D13	D14	D15
0	0	0	0	0	1	0	1	0	1	0	1	0	1	0	1	0	1	0	1
0	0	0	1	0	0	1	1	0	0	1	1	0	0	1	1	0	0	1	1
0	0	1	0	0	0	0	0	1	1	1	1	0	0	0	0	1	1	1	1
0	0	1	1	0	0	0	0	0	0	0	0	1	1	1	1	1	1	1	1
D6	D5	D4	HEX	0	1	2	3	4	5	6	7	8	9	A	B	C	D	E	F
0	0	0	0	THESE CODES DISPLAY BLANK															
0	0	1	1																
0	1	0	2		:	:	:	:	:	:	:	:	:	:	:	:	:	:	:
0	1	1	3	:	:	:	:	:	:	:	:	:	:	:	:	:	:	:	:
1	0	0	4	:	:	:	:	:	:	:	:	:	:	:	:	:	:	:	:
1	0	1	5	:	:	:	:	:	:	:	:	:	:	:	:	:	:	:	:
1	1	0	6	:	:	:	:	:	:	:	:	:	:	:	:	:	:	:	:
1	1	1	7	:	:	:	:	:	:	:	:	:	:	:	:	:	:	:	:

- Notes: 1. High = 1 level.
 2. Low = 0 level.
 3. Upon power up, the device will initialize in a random state.