

GaAs Flip Chip Schottky Diodes



Features

- Designed for High Volume Designs
- High Frequency (20–100 GHz)
- Exceeds Environmental Requirements for MIC & Hybrid Applications
- Designed for Low Junction Capacitance and Low Series Resistance
- Applications Include PCN Mixers and Circuits, As Well As Low Power, Fast Switching
- Low Parasitic Flip Chip Configuration

Description

This new series of GaAs Schottky barrier diodes offer high performance at commercial market prices. They are designed for low junction capacitance, as well as low series resistance. Diodes are designed for MIC work (hard and soft substrates), but the leadless design eliminates the problems associated with mounting of beam lead diodes. Due to its rigid construction, it exceeds environmental requirements for MIC and hybrid applications. Diodes can be supplied on expandable film frame for high speed pick and place process. Standard packing will be in a gel pack. Flexible conductive epoxy is the most effective method for circuitry attachments. Standard mounting temperatures should not exceed 175°C.

Single - DMK2783-000, DMK2790-000

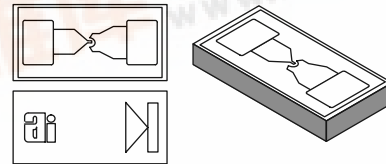

Anti-Parallel - DMK2308-000

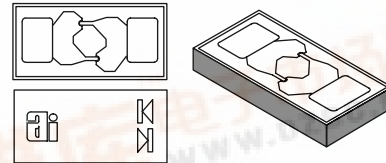

Series Pair - DMK8001-000

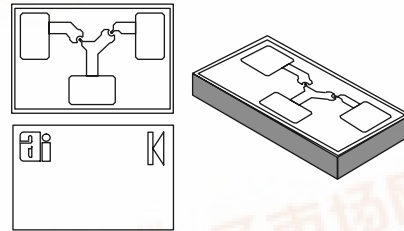

Electrical Specifications at 25°C

Recommended Frequency (GHz)	V_B^1 @ 10 μ A (V)	C_T^2 0 V, 1 MHz (pF)		R_S @ 10 mA (Ω)	V_F @ 1 mA (mV)		Single	Series Pair	Anti-Parallel
		Min.	Max.		Max.	Min.	Max.	540-011	540-012
20–100	3.0	0.03	0.05	9	680	780	DMK2783-000		
20–100	3.0	0.04	0.07	7	650	750	DMK2790-000		DMK2308-000
20–100	3.0	0.05	0.08	7	650	750		DMK8001-000	

1. V_B cannot be measured nondestructively in anti-parallel configuration.
 2. C_T = junction capacitance plus 0.02 pF (overlay).



Typical Parameter Distribution on Wafer

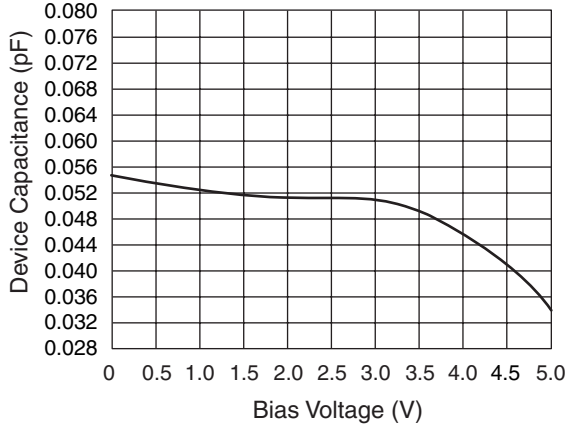

Capacitance/Voltage Variation

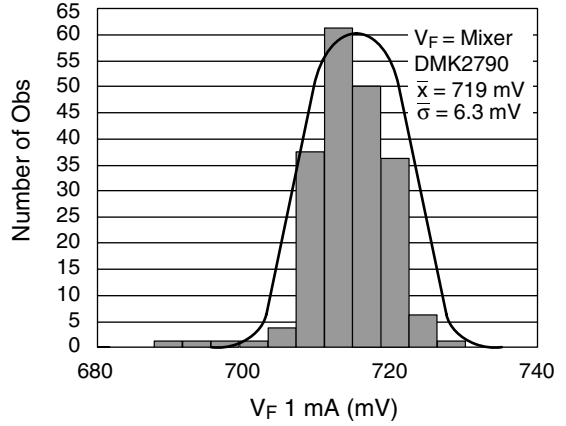

Histogram

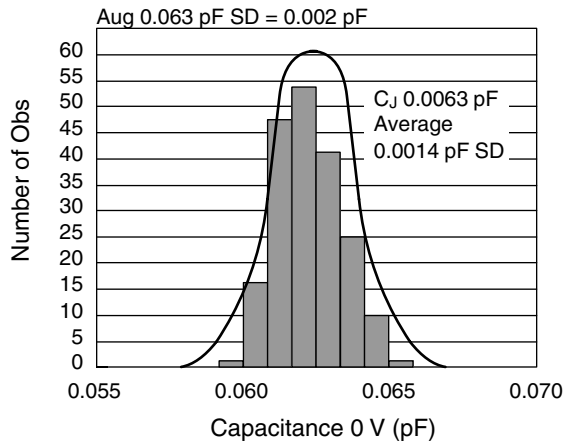

Histogram

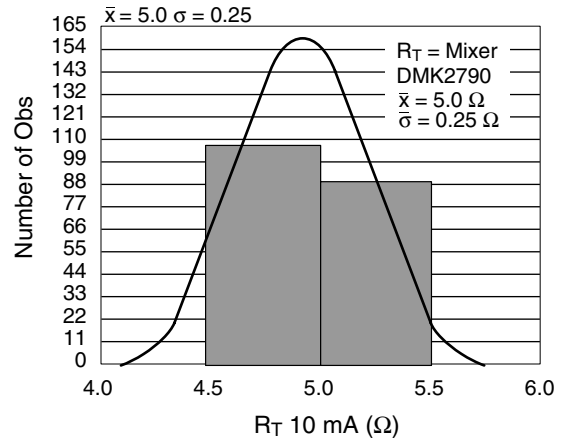

Histogram

Spice Parameters (Per Junction)

I_s Amp	R_s Ω	n	T_D S	C_{j0} pF	m	E_G eV	V_J eV	X_{TT}	FC	B_V V	I_{BV} A
0.5 E-12	4	1.05	1E-11	0.05	0.26	1.43	0.82	2	0.5	4.0	1E-05

Suggested Setup Values For WEST-BOND Model 7200A Epoxy Die Bonder

Materials

Epoxy

Microelectronic grade one component, solvent-free silver-filled, electrically conductive adhesive — example: Ablebond 8380 by Ablestick.

Dispense Tube

WEST-BOND B-1831-1 with 9.5 mil I.D., or WEST-BOND B-1831-2 with 15.5 mil I.D. Other sizes available.

Die Pickup Tool

SPT Part Number 2101-W625-CT-031 x 0.016 x 0.0075. Hole diameter 0.016" face diameter 0.031", O.D. 0.625". Use vacuum pressure to pick and place chip.

Adjustment

Bond Force

35 grams at tool.

Dispense Air

30 psi.

Dispense Time

To give diameter of dot required.

Curing Time

Temperature	Time
250°C	10 min.
130°C	20 min.
100°C	60 min.
85°C	120 min.

Flexible Conductive Epoxy Mounting of Alpha Beamless Flip Chip Diodes – To Soft or Hard Substrate – As Plated

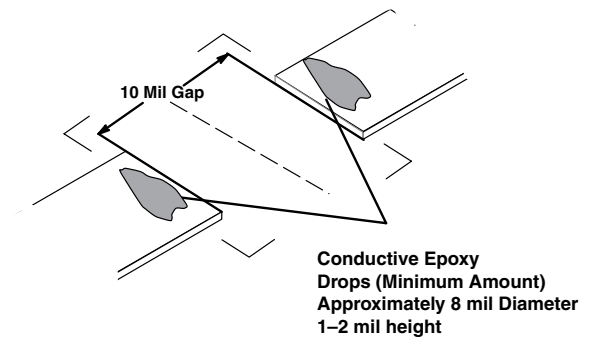

Deposit Conductive Epoxy

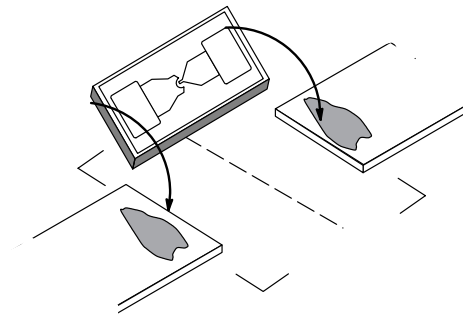

Perform Die Attach

- Flip Device
- Align Bond Pads to Epoxy Dot (Alignment Marks Help)
- Use Even Pressure to Make Correct Connection

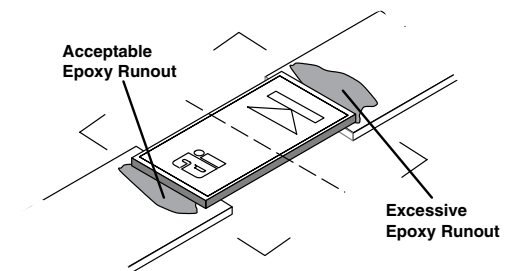

Cure Epoxy & DC Continuity Check

- Inspect for Adequate Epoxy Fillet
- Cure According to Mfg. Preferred Schedule. Typically 110–150°C @ 60 Minutes, or 150°C, 4 Minutes for Snap-Cure Epoxies

Outline Drawings

540-011

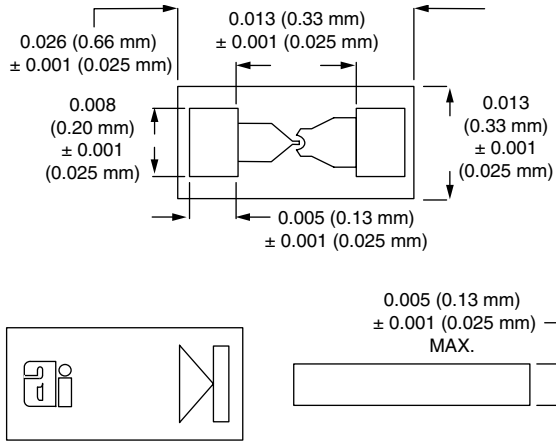

540-025

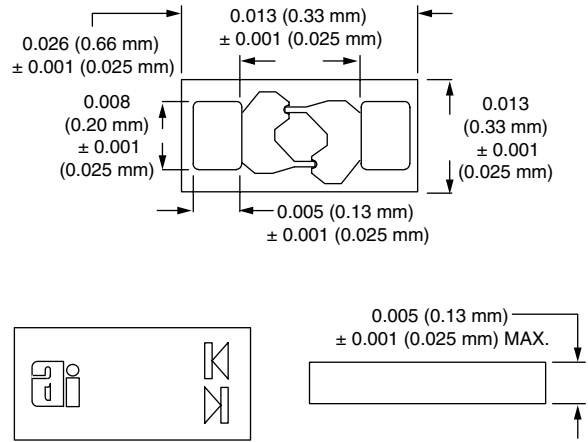

540-012

