



August 1998

54FCT240

Octal Buffer/Line Driver with TRI-STATE® Outputs

General Description

The 54FCT240 is an octal buffer and line driver designed to be employed as a memory address driver, clock driver and bus oriented transmitter or receiver which provides improved PC board density.

Features

- Inverting TRI-STATE outputs drive bus lines or buffer memory address registers
- Output sink capability of 32 mA, source capability of 12 mA
- TTL input and output compatible levels
- CMOS power consumption
- Standard Microcircuit Drawing (SMD) 5962-8765501

Ordering Code:

Military	Package Number	Package Description
54FCT240DMQB	J20A	20-Lead Ceramic Dual-In-Line
54FCT240FMQB	W20A	20-Lead Cerpak
54FCT240LMQB	E20A	20-Lead Ceramic Leadless Chip Carrier, Type C

Logic Symbol

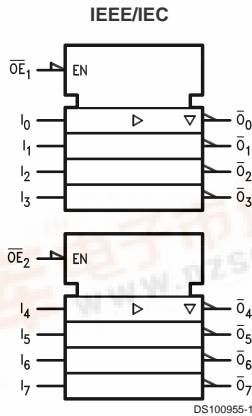

Pin Names	Description
$\overline{OE}_1, \overline{OE}_2$	TRI-STATE Output Enable Inputs
I_0-I_7	Inputs
$\overline{O}_0-\overline{O}_7$	Outputs

Connection Diagrams

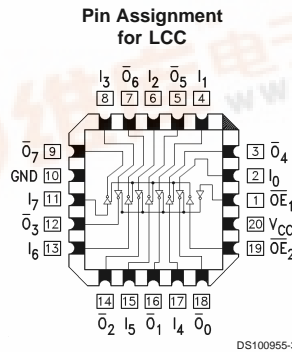
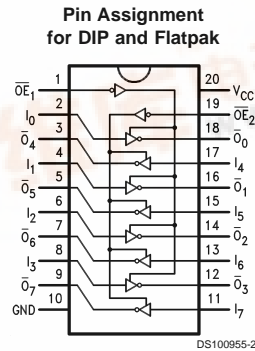

TRI-STATE® is a registered trademark of National Semiconductor Corporation.
FACT® is a registered trademark of Fairchild Semiconductor Corporation.

54FCT240 Octal Buffer/Line Driver with TRI-STATE Outputs



Connection Diagrams (Continued)

Inputs		Outputs (Pins 12, 14, 16, 18)
\overline{OE}_1	I_n	
L	L	H
L	H	L
H	X	Z

Inputs		Outputs (Pins 3, 5, 7, 9)
\overline{OE}_2	I_n	
L	L	H
L	H	L
H	X	Z

H = HIGH Voltage Level
 L = LOW Voltage Level
 X = Immaterial
 Z = High Impedance

Absolute Maximum Ratings (Note 1)

If Military/Aerospace specified devices are required, please contact the National Semiconductor Sales Office/ Distributors for availability and specifications.

Storage Temperature	-65°C to +150°C
Ambient Temperature under Bias	-55°C to +125°C
Junction Temperature under Bias	
Ceramic	-55°C to +175°C
V _{CC} Pin Potential to Ground Pin	-0.5V to +7.0V
Input Voltage (Note 1)	-0.5V to +7.0V
Input Current (Note 1)	-30 mA to +5.0 mA
Voltage Applied to Any Output in the Disabled or Power-off State	-0.5V to 5.5V

in the HIGH State -0.5V to V_{CC}
 Current Applied to Output
 in LOW State (Max) twice the rated I_{OL} (mA)

Recommended Operating Conditions

Free Air Ambient Temperature	
Military	-55°C to +125°C
Supply Voltage	
Military	+4.5V to +5.5V

Note 1: Absolute maximum ratings are those values beyond which damage to the device may occur. The databook specifications should be met, without exception, to ensure that the system design is reliable over its power supply, temperature, and output/input loading variables. National does not recommend operation of FACT® circuits outside databook specifications.

DC Characteristics for 'FCT Family Devices

Symbol	Parameter	FCT240		Units	V _{CC}	Conditions
		Min	Max			
V _{IH}	Input HIGH Voltage	2.0		V		Recognized HIGH Signal
V _{IL}	Input LOW Voltage		0.8	V		Recognized LOW Signal
V _{CD}	Input Clamp Diode Voltage		-1.2	V	Min	I _{IN} = -18 mA
V _{OH}	Output HIGH Voltage	54FCT	4.3	V	Min	I _{OH} = -300 μA
		54FCT	2.4	V	Min	I _{OH} = -12 mA
V _{OL}	Output LOW Voltage	54FCT	0.2	V	Min	I _{OL} = 300 μA
		54FCT	0.5	V	Min	I _{OL} = 32 mA
I _{IH}	Input HIGH Current		5	μA	Max	V _{IN} = 5.5V
I _{IL}	Input LOW Current		-5	μA	Max	V _{IN} = 0.0V
I _{OZH}	High Impedance Output Current		10	μA	Max	V _{IN} = 5.5V
I _{OZL}	High Impedance Output Current		-10	μA	Max	V _{IN} = 0.0V
I _{OS}	Output Short-Circuit Current		-60	mA	Max	V _{OUT} = 0.0V
I _{CCQ}	Power Supply Current		1.5	mA	Max	V _{IN} = 0.2V or V _{IN} = 5.3V
ΔI _{CC}	Power Supply Current		2.0	mA	Max	V _{IN} = 3.4V
I _{CCT}	Total Power Supply Current		4.8	mA	Max	V _{IN} = 3.4V or V _{IN} = GND, OE = GND, f _i = 10Mhz, outputs open, one bit toggling - 50% duty cycle
			4.0	mA	Max	V _{IN} = 5.3V or V _{IN} = 0.2V, OE = GND, f _i = 10Mhz, outputs open, one bit toggling - 50% duty cycle
I _{CCD}	Dynamic I _{CC} No Load		0.25	mA/MHz	Max	Outputs Open, OE = GND, One Bit Toggling, 50% Duty Cycle

AC Electrical Characteristics					
Symbol	Parameter	54FCT240		Units	Fig. No.
		$T_A = -55^\circ\text{C to } +125^\circ\text{C}$ $V_{CC} = 4.5\text{V} - 5.5\text{V}$ $C_L = 50\text{ pF}$			
		Min	Max		
t_{PLH}	Propagation Delay	1.5	9.0	ns	
t_{PHL}	Data to Outputs	1.5	9.0		
t_{PZH}	Output Enable	1.5	10.5	ns	
t_{PZL}	Time	1.5	10.5		
t_{PHZ}	Output Disable	1.5	12.5	ns	
t_{PLZ}	Time	1.5	12.5		

Capacitance				
Symbol	Parameter	Max	Units	Conditions
C_{IN}	Input Capacitance	10	pF	$V_{CC} = \text{OPEN}$
C_{PD}	Power Dissipation Capacitance	12	pF	$V_{CC} = 5.0\text{V}$

Physical Dimensions inches (millimeters) unless otherwise noted

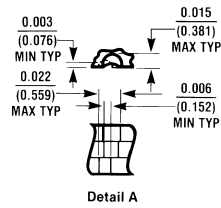
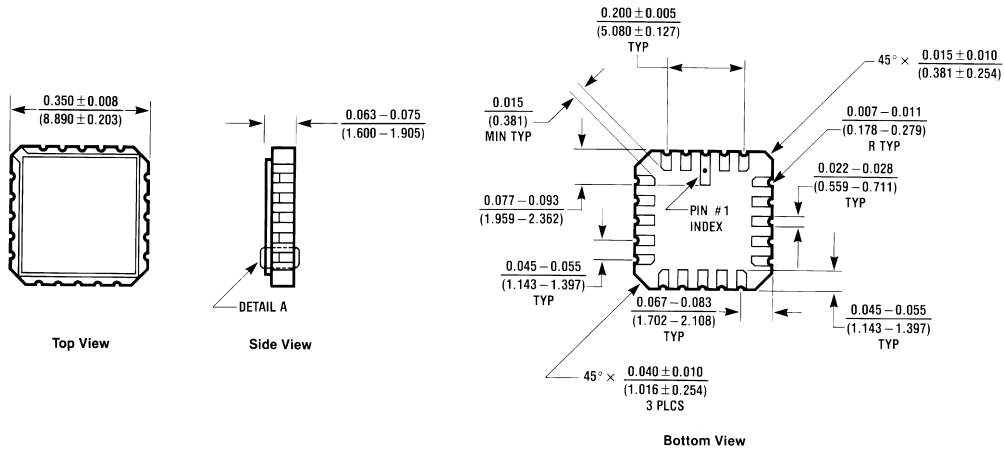

E20A (REV D)

**20 Terminal Ceramic Leadless Chip Carrier (L)
NS Package Number E20A**

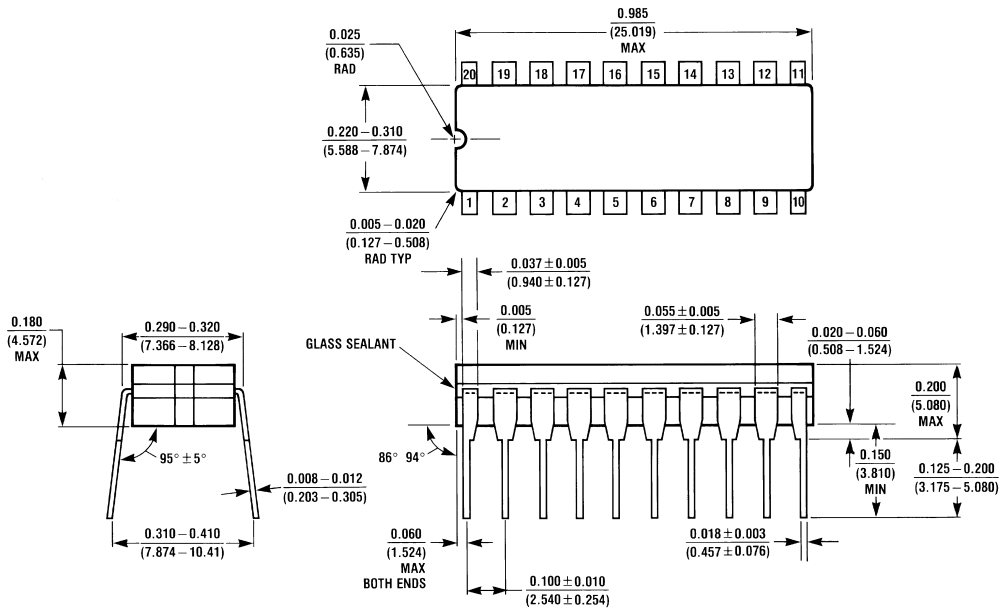

J20A (REV M)

**20 Lead Ceramic Dual-In-Line Package (D)
NS Package Number J20A**

Physical Dimensions inches (millimeters) unless otherwise noted (Continued)

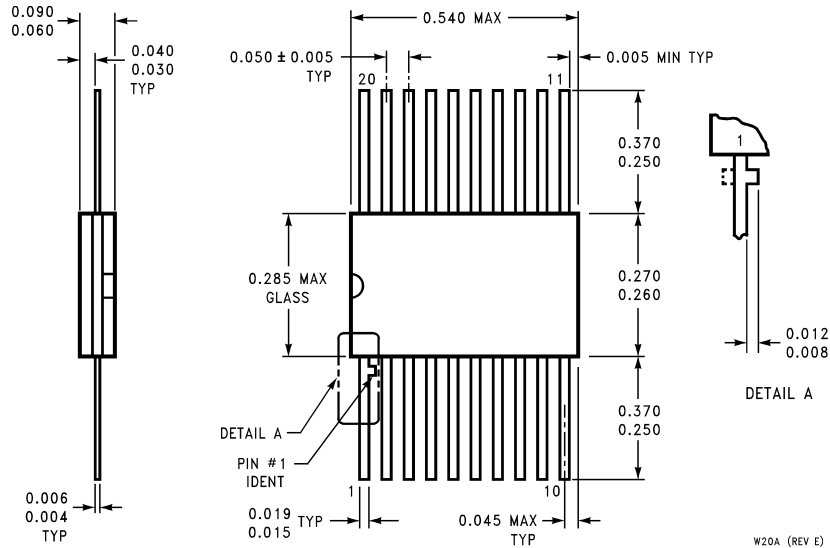

**20 Lead Ceramic Flatpak (F)
NS Package Number W20A**

LIFE SUPPORT POLICY

NATIONAL'S PRODUCTS ARE NOT AUTHORIZED FOR USE AS CRITICAL COMPONENTS IN LIFE SUPPORT DEVICES OR SYSTEMS WITHOUT THE EXPRESS WRITTEN APPROVAL OF THE PRESIDENT AND GENERAL COUNSEL OF NATIONAL SEMICONDUCTOR CORPORATION. As used herein:

1. Life support devices or systems are devices or systems which, (a) are intended for surgical implant into the body, or (b) support or sustain life, and whose failure to perform when properly used in accordance with instructions for use provided in the labeling, can be reasonably expected to result in a significant injury to the user.
2. A critical component is any component of a life support device or system whose failure to perform can be reasonably expected to cause the failure of the life support device or system, or to affect its safety or effectiveness.



National Semiconductor Corporation
Americas
Tel: 1-800-272-9959
Fax: 1-800-737-7018
Email: support@nsc.com

www.national.com

National Semiconductor Europe

Fax: +49 (0) 1 80-530 85 86
Email: europe.support@nsc.com
Deutsch Tel: +49 (0) 1 80-530 85 85
English Tel: +49 (0) 1 80-532 78 32
Français Tel: +49 (0) 1 80-532 93 58
Italiano Tel: +49 (0) 1 80-534 16 80

National Semiconductor Asia Pacific Customer Response Group

Tel: 65-2544466
Fax: 65-2504466
Email: sea.support@nsc.com

National Semiconductor Japan Ltd.

Tel: 81-3-5639-7560
Fax: 81-3-5639-7507