



DMV1500M

DAMPER + MODULATION DIODE FOR VIDEO

MAIN PRODUCT CHARACTERISTICS

	MODUL	DAMPER
$I_{F(AV)}$	3 A	6 A
V_{RRM}	600 V	1500 V
$t_{rr} (max)$	50 ns	135 ns
$V_F (max)$	1.4 V	1.65 V

FEATURES AND BENEFITS

- Full kit in one package
- High breakdown voltage capability
- Very fast recovery diode
- Specified turn on switching characteristics
- Low static and peak forward voltage drop for low dissipation
- Insulated version:
Insulated voltage = 2500 V_{RMS}
Capacitance = 7 pF
- Planar technology allowing high quality and best electrical characteristics
- Outstanding performance of well proven DTV as damper and new faster Turbo 2 600V technology as modulation

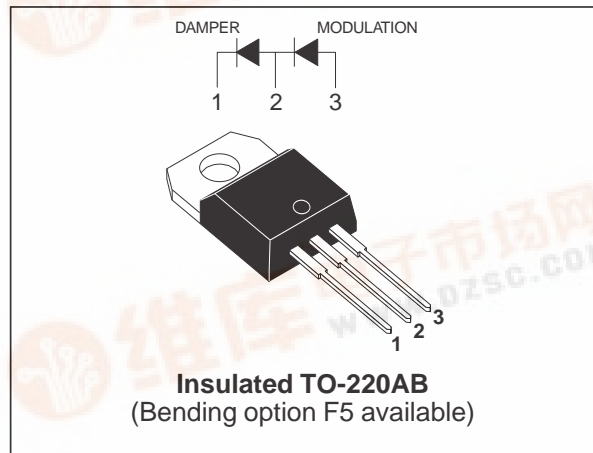

DESCRIPTION

High voltage semiconductor especially designed for horizontal deflection stage in standard and high resolution video display with E/W correction.

The insulated TO-220AB package includes both the DAMPER diode and the MODULATION diode. Assembled on automated line, it offers excellent insulating and dissipating characteristics, thanks to the internal ceramic insulation layer.

ABSOLUTE RATINGS (limiting values, per diode)

Symbol	Parameter	Value		Unit
		MODUL	DAMPER	
V_{RRM}	Repetitive peak reverse voltage	600	1500	V
I_{FSM}	Surge non repetitive forward current	35	75	A
T_{stg}	Storage temperature range	- 40 to + 150		°C
T_j	Maximum operating junction temperature	150		

DMV1500M

THERMAL RESISTANCES

Symbol	Parameter	Value	Unit
$R_{th(j-c)}$	Damper junction to case	4.8	°C/W
$R_{th(j-c)}$	Modulation junction to case	6	

STATIC ELECTRICAL CHARACTERISTICS OF THE DAMPER DIODES

Symbol	Parameter	Test conditions	Value				Unit
			Tj = 25°C		Tj = 125°C		
			Typ.	Max.	Typ.	Max.	
V_F *	Forward voltage drop	$I_F = 6\text{ A}$	1.4	2.2	1.2	1.65	V
I_R **	Reverse leakage current	$V_R = 1500\text{ V}$		100	100	1000	μA

Pulse test : * $t_p = 380\ \mu\text{s}$, $\delta < 2\%$
 ** $t_p = 5\ \text{ms}$, $\delta < 2\%$

To evaluate the maximum conduction losses of the DAMPER diode use the following equations :

$$P = 1.37 \times I_{F(AV)} + 0.047 \times I_F^2 \text{ (RMS)}$$

STATIC ELECTRICAL CHARACTERISTICS OF THE MODULATION DIODE

Symbol	Parameter	Test conditions	Value				Unit
			Tj = 25°C		Tj = 125°C		
			Typ.	Max.	Typ.	Max.	
V_F *	Forward voltage drop	$I_F = 3\text{ A}$		1.8	1.1	1.4	V
I_R **	Reverse leakage current	$V_R = 600\text{ V}$		20	3	50	μA

Pulse test : * $t_p = 380\ \mu\text{s}$, $\delta < 2\%$
 ** $t_p = 5\ \text{ms}$, $\delta < 2\%$

To evaluate the maximum conduction losses of the MODULATION diode use the following equations :

$$P = 1.12 \times I_{F(AV)} + 0.092 \times I_F^2 \text{ (RMS)}$$

RECOVERY CHARACTERISTICS OF THE DAMPER DIODE

Symbol	Parameter	Test conditions	Value		Unit	
			Typ.	Max.		
t_{rr}	Reverse recovery time	$I_F = 100\text{ mA}$ $I_R = 100\text{ mA}$ $I_{RR} = 10\text{ mA}$		750	ns	
t_{rr}	Reverse recovery time	$I_F = 1\text{ A}$ $dI_F/dt = -50\text{ A}/\mu\text{s}$ $V_R = 30\text{ V}$		110	135	ns

RECOVERY CHARACTERISTICS OF THE MODULATION DIODE

Symbol	Parameter	Test conditions		Value		Unit
				Typ.	Max.	
t_{rr}	Reverse recovery time	$I_F = 100\text{mA}$ $I_R = 100\text{mA}$ $I_{RR} = 10\text{mA}$	$T_j = 25^\circ\text{C}$	110	350	ns
t_{rr}	Reverse recovery time	$I_F = 1\text{A}$ $di_F/dt = -50\text{A}/\mu\text{s}$ $V_R = 30\text{V}$	$T_j = 25^\circ\text{C}$		50	ns

TURN-ON SWITCHING CHARACTERISTICS OF THE DAMPER DIODE

Symbol	Parameter	Test conditions		Value		Unit
				Typ.	Max.	
t_{fr}	Forward recovery time	$I_F = 6\text{A}$ $di_F/dt = 80\text{A}/\mu\text{s}$ $V_{FR} = 3\text{V}$	$T_j = 100^\circ\text{C}$	570		ns
V_{FP}	Peak forward voltage	$I_F = 6\text{A}$ $di_F/dt = 80\text{A}/\mu\text{s}$	$T_j = 100^\circ\text{C}$	21	28	V

TURN-ON SWITCHING CHARACTERISTICS OF THE MODULATION DIODE

Symbol	Parameter	Test conditions		Value		Unit
				Typ.	Max.	
t_{fr}	Forward recovery time	$I_F = 3\text{A}$ $di_F/dt = 80\text{A}/\mu\text{s}$ $V_{FR} = 2\text{V}$	$T_j = 100^\circ\text{C}$		240	ns
V_{FP}	Peak forward voltage	$I_F = 3\text{A}$ $di_F/dt = 80\text{A}/\mu\text{s}$	$T_j = 100^\circ\text{C}$		8	V

DMV1500M

Fig. 1-1: Power dissipation versus peak forward current (triangular waveform, $\delta = 0.45$) (damper diode).

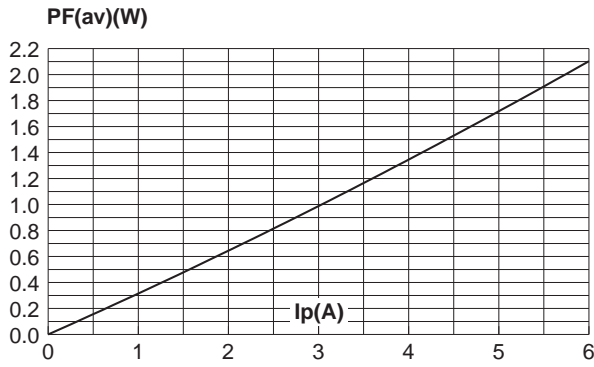

Fig. 1-2: Power dissipation versus peak forward current (triangular waveform, $\delta = 0.45$) (modulation diode).

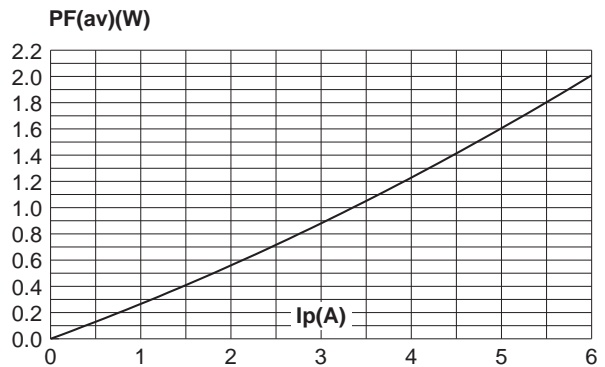

Fig. 2-1: Average forward current versus ambient temperature (damper diode).

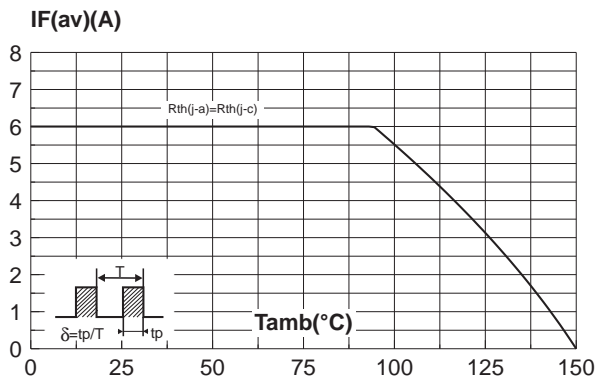

Fig. 2-2: Average forward current versus ambient temperature (modulation diode).

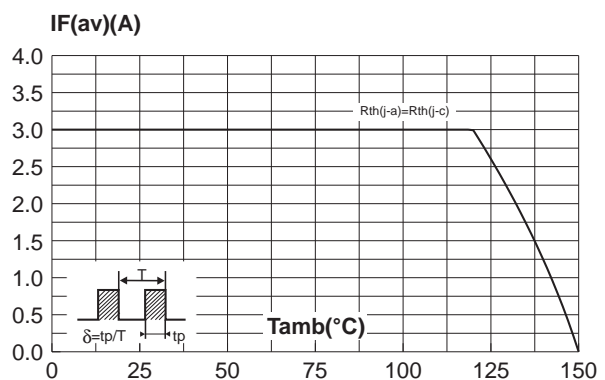

Fig. 3-1: Forward voltage drop versus forward current (damper diode).

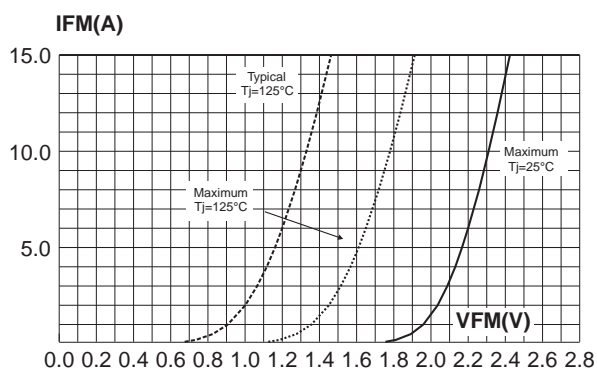

Fig. 3-2: Forward voltage drop versus forward current (modulation diode).

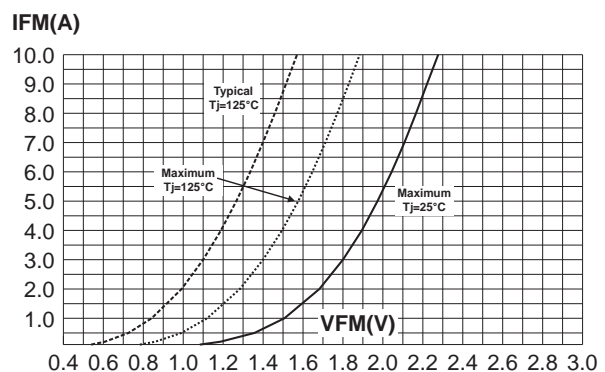

Fig. 4: Relative variation of thermal impedance junction to case versus pulse duration.

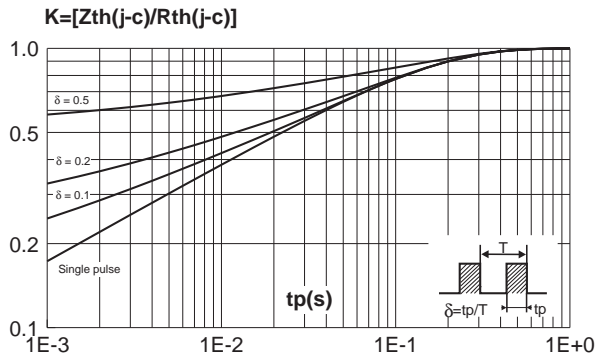

Fig. 5-1: Non repetitive surge peak forward current versus overload duration (damper diode).

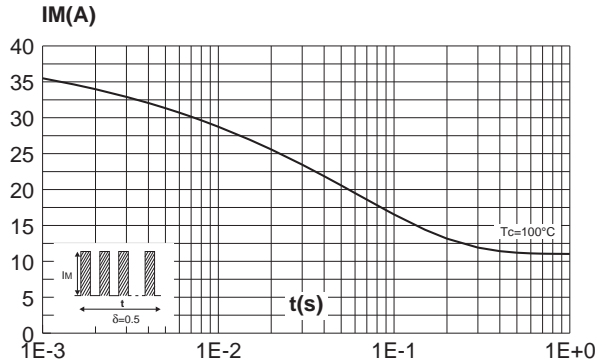

Fig. 5-2: Non repetitive surge peak forward current versus overload duration (modulation diode).

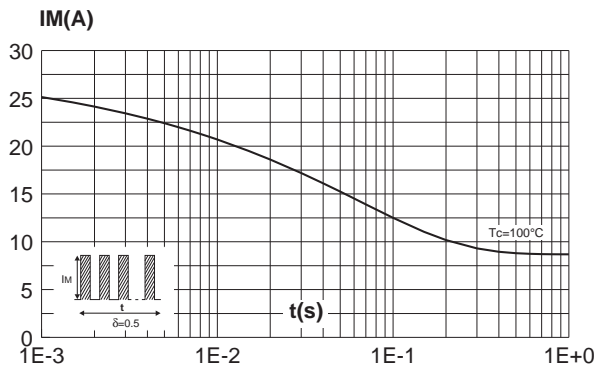

Fig. 6-1: Reverse recovery charges versus dI_F/dt (damper diode).

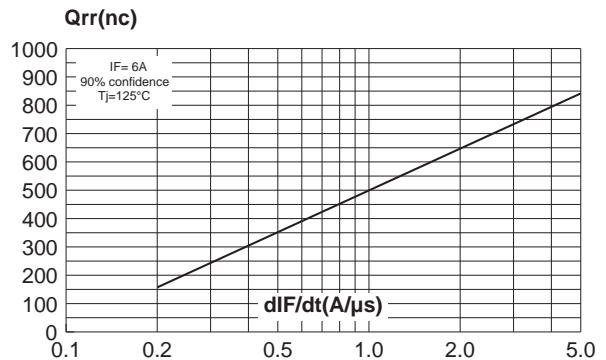

Fig. 6-2: Reverse recovery charges versus dI_F/dt (modulation diode).

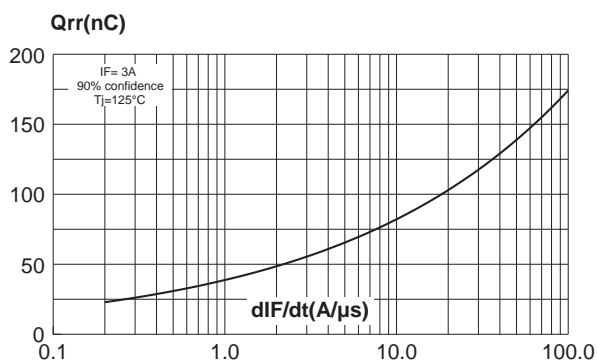
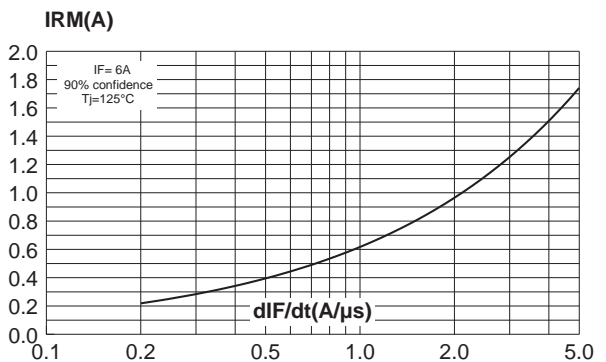

Fig. 7-1: Reverse recovery current versus dI_F/dt (damper diode).



DMV1500M

Fig. 7-2: Reverse recovery current versus dI_F/dt (modulation diode).

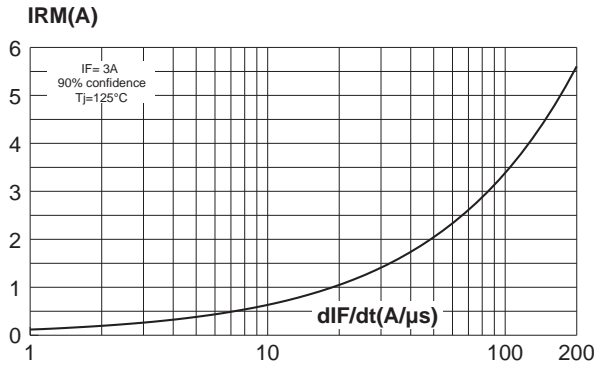

Fig. 8-2: Transient peak forward voltage versus dI_F/dt (modulation diode).

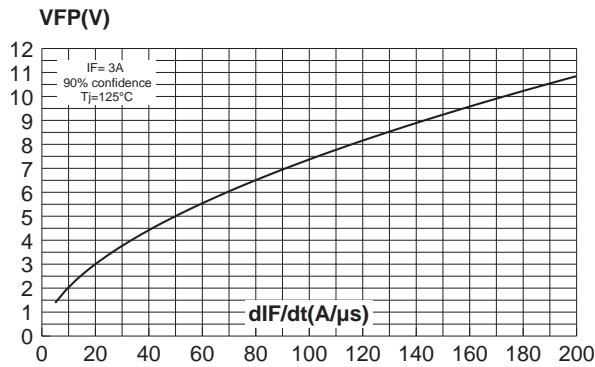

Fig. 9-2: Forward recovery time versus dI_F/dt (modulation diode).

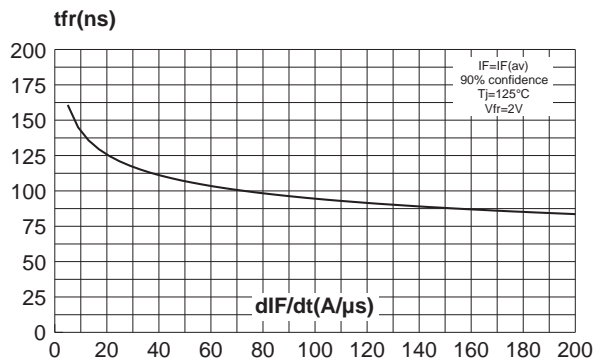

Fig. 8-1: Transient peak forward voltage versus dI_F/dt (damper diode).

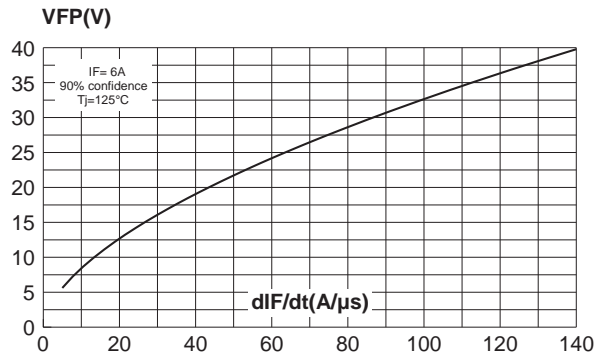

Fig. 9-1: Forward recovery time versus dI_F/dt (damper diode).

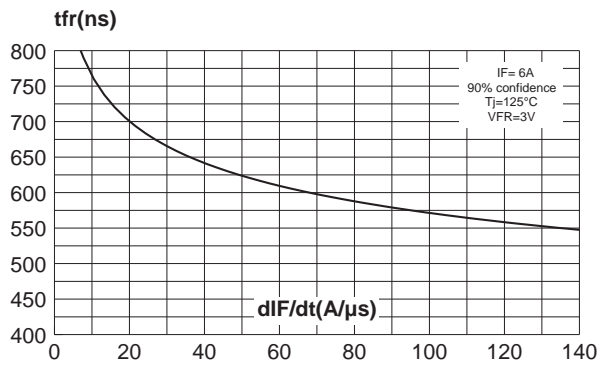
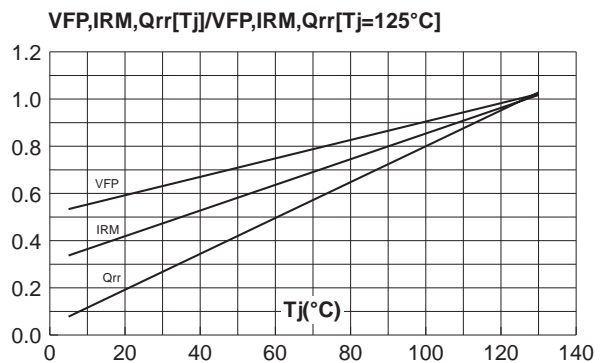
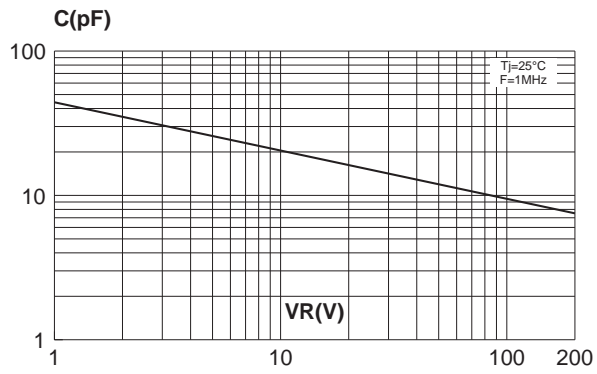

Fig. 10: Dynamic parameters versus junction temperature (damper & modulation diodes).



DMV1500M

Fig. 11: Junction capacitance versus reverse voltage applied (typical values) (damper & modulation diodes).



ORDERING INFORMATION

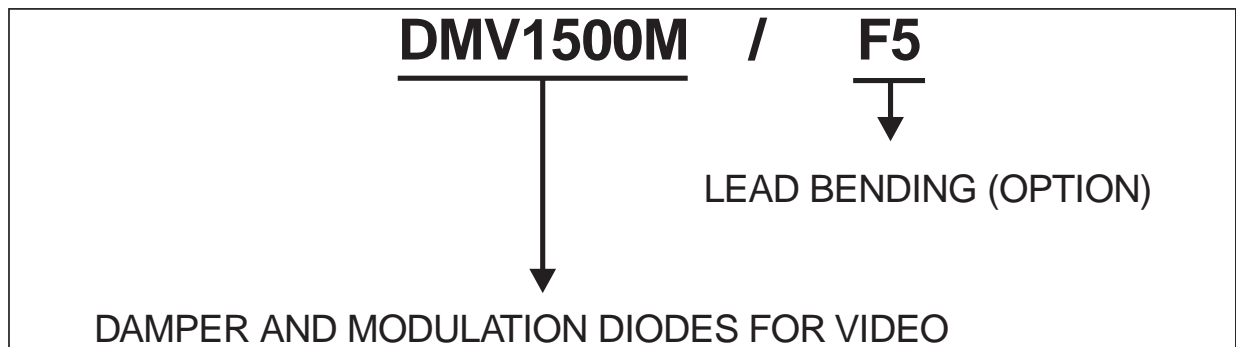

DMV1500M

PACKAGE MECHANICAL DATA TO-220AB F5 OPTION

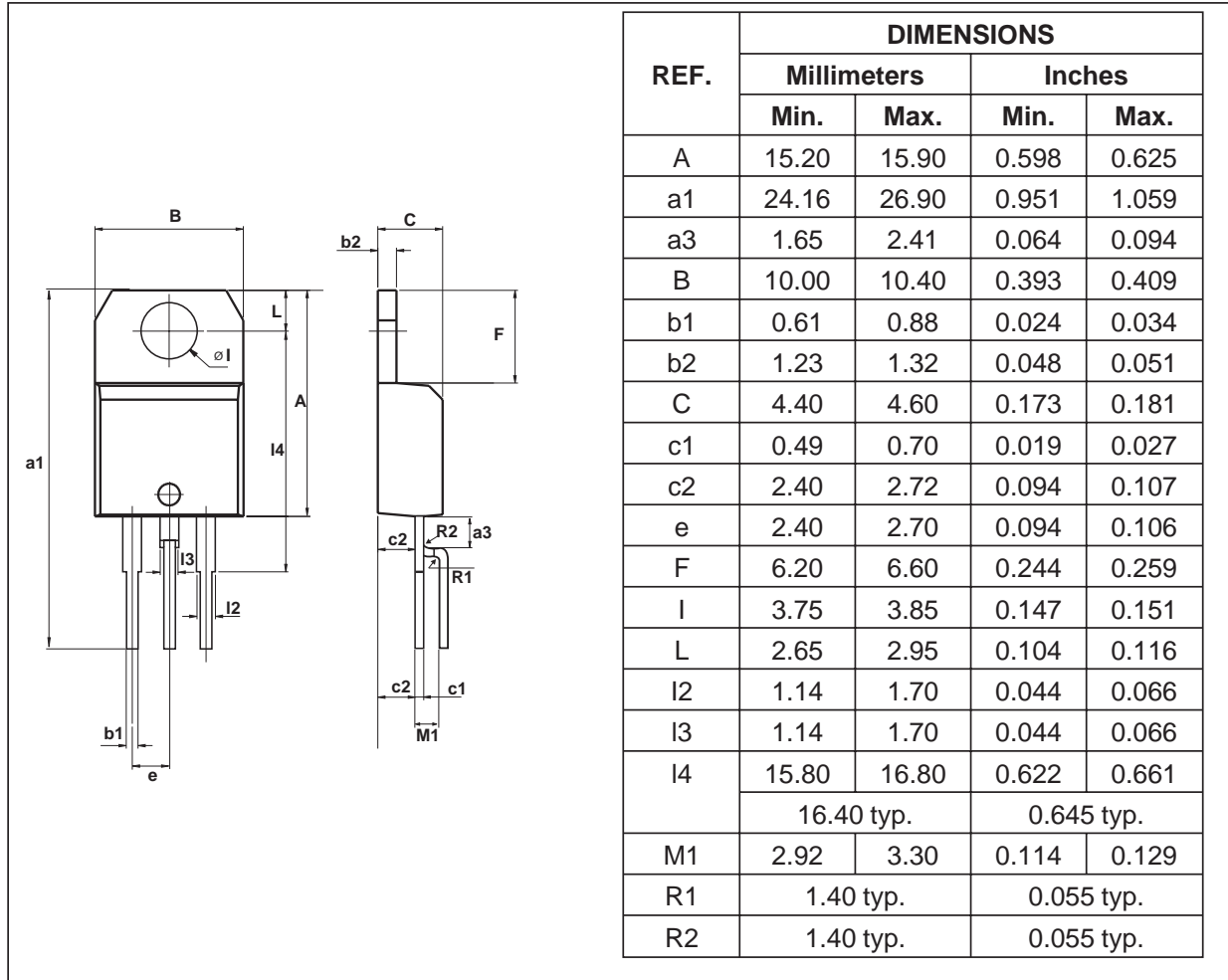

PRINTED CIRCUIT LAYOUT FOR F5 LAYOUT

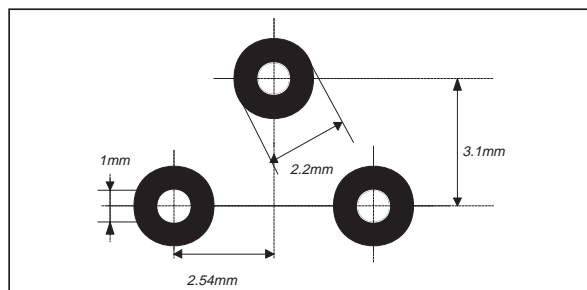

- Cooling method: by conduction (c)
- Recommended torque value: 0.8 m.N.
- Maximum torque value: 1 m.N.

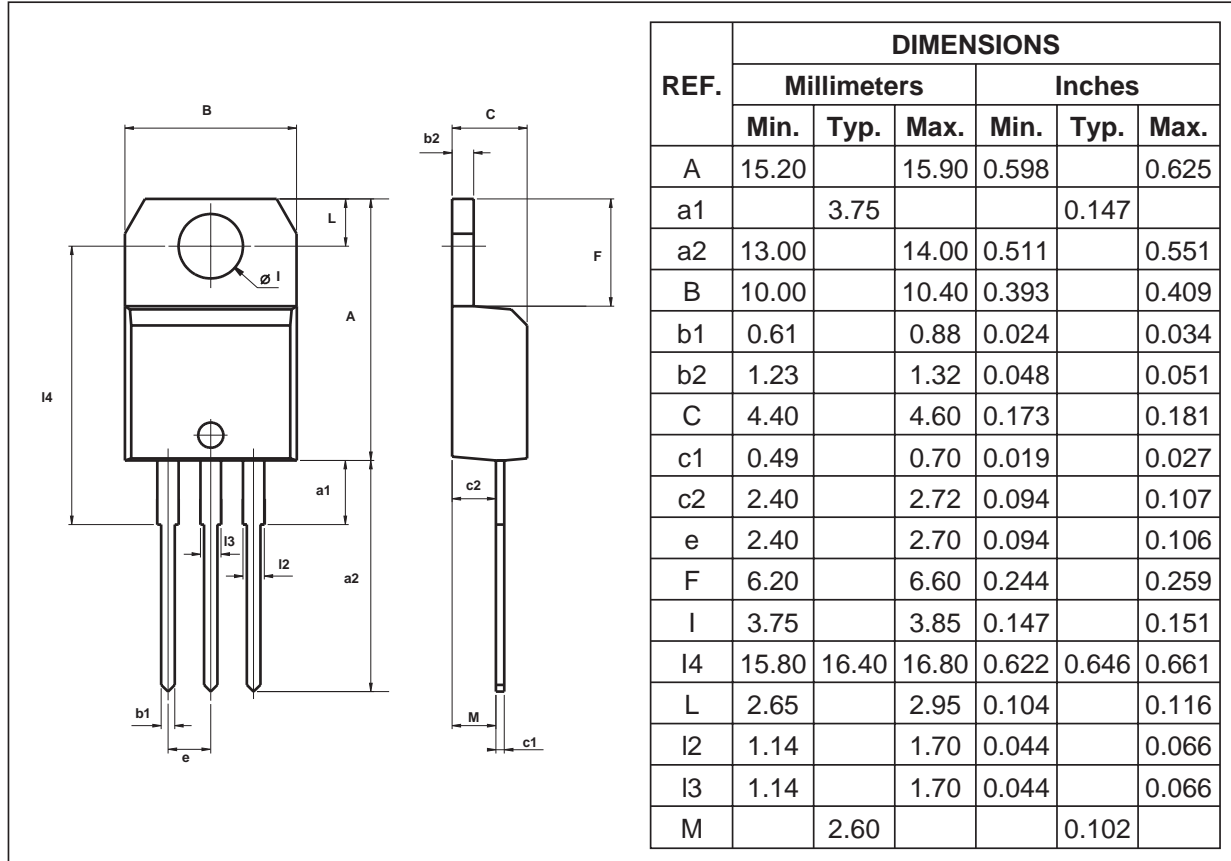
PACKAGE MECHANICAL DATA
 TO-220AB

- Cooling method: by conduction (c)
- Recommended torque value: 0.8 m.N.
- Maximum torque value: 1 m.N.

Type	Marking	Package	Weight	Base qty	Delivery mode
DMV1500M DMV1500MF5	DMV1500M	TO-220AB	2.2 g.	50	Tube

- Epoxy meets UL94, V0

Information furnished is believed to be accurate and reliable. However, STMicroelectronics assumes no responsibility for the consequences of use of such information nor for any infringement of patents or other rights of third parties which may result from its use. No license is granted by implication or otherwise under any patent or patent rights of STMicroelectronics. Specifications mentioned in this publication are subject to change without notice. This publication supersedes and replaces all information previously supplied. STMicroelectronics products are not authorized for use as critical components in life support devices or systems without express written approval of STMicroelectronics.

The ST logo is a registered trademark of STMicroelectronics

© 2001 STMicroelectronics - Printed in Italy - All rights reserved.

STMicroelectronics GROUP OF COMPANIES

Australia - Brazil - China - Finland - France - Germany - Hong Kong - India - Italy - Japan - Malaysia
 Malta - Morocco - Singapore - Spain - Sweden - Switzerland - United Kingdom - U.S.A.

<http://www.st.com>