



N-Channel Depletion-Mode Vertical DMOS FETs

Ordering Information

BV _{DSX} / BV _{DGX}	R _{DS(ON)} (max)	I _{DSS} (min)	Order Number / Package		
			TO-92	TO-243AA*	Die
450V	20Ω	200mA	DN3545N3	DN3545N8	DN3545ND

Product marking for TO-243AA:

DN5M*

Where * = 2-week alpha date code

* Same as SOT-89. Product shipped on 2000 piece carrier tape reels.

Features

- High input impedance
- Low input capacitance
- Fast switching speeds
- Low on resistance
- Free from secondary breakdown
- Low input and output leakage

Applications

- Normally-on switches
- Solid state relays
- Converters
- Constant current sources
- Power supply circuits
- Telecom

Absolute Maximum Ratings

Drain-to-Source Voltage	BV _{DSX}
Drain-to-Gate Voltage	BV _{DGX}
Gate-to-Source Voltage	± 20V
Operating and Storage Temperature	-55°C to +150°C
Soldering Temperature*	300°C

* Distance of 1.6 mm from case for 10 seconds.

Advanced DMOS Technology

These depletion-mode (normally-on) transistors utilize an advanced vertical DMOS structure and Supertex's well-proven silicon-gate manufacturing process. This combination produces devices with the power handling capabilities of bipolar transistors and with the high input impedance and positive temperature coefficient inherent in MOS devices. Characteristic of all MOS structures, these devices are free from thermal runaway and thermally-induced secondary breakdown.

Supertex's vertical DMOS FETs are ideally suited to a wide range of switching and amplifying applications where high breakdown voltage, high input impedance, low input capacitance, and fast switching speeds are desired.

Package Options

TO-243AA
(SOT-89)

TO-92

Note: See Package Outline section for dimensions.



Thermal Characteristics

Package	I _D (continuous)*	I _D (pulsed)	Power Dissipation @ T _A = 25°C	θ _{Jc} °C/W	θ _{ja} °C/W	I _{DR} *	I _{DRM}
TO-92	136mA	1.6A	0.74W	125	170	136mA	1.6A
TO-243AA	200mA	300mA	1.6†	15	78†	200mA	300mA

* I_D (continuous) is limited by max rated T_r.

† Mounted on FR4 board, 25mm x 25mm x 1.57mm. Significant P_D increase possible on ceramic substrate.

Electrical Characteristics (@ 25°C unless otherwise specified)

Symbol	Parameter	Min	Typ	Max	Unit	Conditions
BV _{DSX}	Drain-to-Source Breakdown Voltage	450			V	V _{GS} = -5V, I _D = 100μA
V _{GS(OFF)}	Gate-to-Source OFF Voltage	-1.5		-3.5	V	V _{DS} = 25V, I _D = 10μA
ΔV _{GS(OFF)}	Change in V _{GS(OFF)} with Temperature			4.5	mV/°C	V _{DS} = 25V, I _D = 10μA
I _{GSS}	Gate Body Leakage Current			100	nA	V _{GS} = ± 20V, V _{DS} = 0V
I _{D(OFF)}	Drain-to-Source Leakage Current			1.0	μA	V _{GS} = -5V, V _{DS} = Max Rating
				1.0	mA	V _{GS} = -5V, V _{DS} = 0.8 Max Rating T _A = 125°C
I _{DSS}	Saturated Drain-to-Source Current	200			mA	V _{GS} = 0V, V _{DS} = 15V
R _{DS(ON)}	Static Drain-to-Source ON-State Resistance			20	Ω	V _{GS} = 0V, I _D = 150mA
ΔR _{DS(ON)}	Change in R _{DS(ON)} with Temperature			1.1	%/°C	V _{GS} = 0V, I _D = 150mA
G _{FS}	Forward Transconductance	150			mS	I _D = 100mA, V _{DS} = 10V
C _{ISS}	Input Capacitance			360	pF	V _{GS} = -5V, V _{DS} = 25V f = 1 MHz
C _{OSS}	Common Source Output Capacitance			40		
C _{RSS}	Reverse Transfer Capacitance			15		
t _{d(ON)}	Turn-ON Delay Time			20	ns	V _{DD} = 25V, I _D = 150mA, R _{GEN} = 25Ω, V _{GS} = 0V to -10V
t _r	Rise Time			30		
t _{d(OFF)}	Turn-OFF Delay Time			30		
t _f	Fall Time			40		
V _{SD}	Diode Forward Voltage Drop			1.8	V	V _{GS} = -5V, I _{SD} = 150mA
t _{rr}	Reverse Recovery Time		800		ns	V _{GS} = -5V, I _{SD} = 150mA

Notes:

- All D.C. parameters 100% tested at 25°C unless otherwise stated. (Pulse test: 300μs pulse, 2% duty cycle.)
- All A.C. parameters sample tested.

Switching Waveforms and Test Circuit

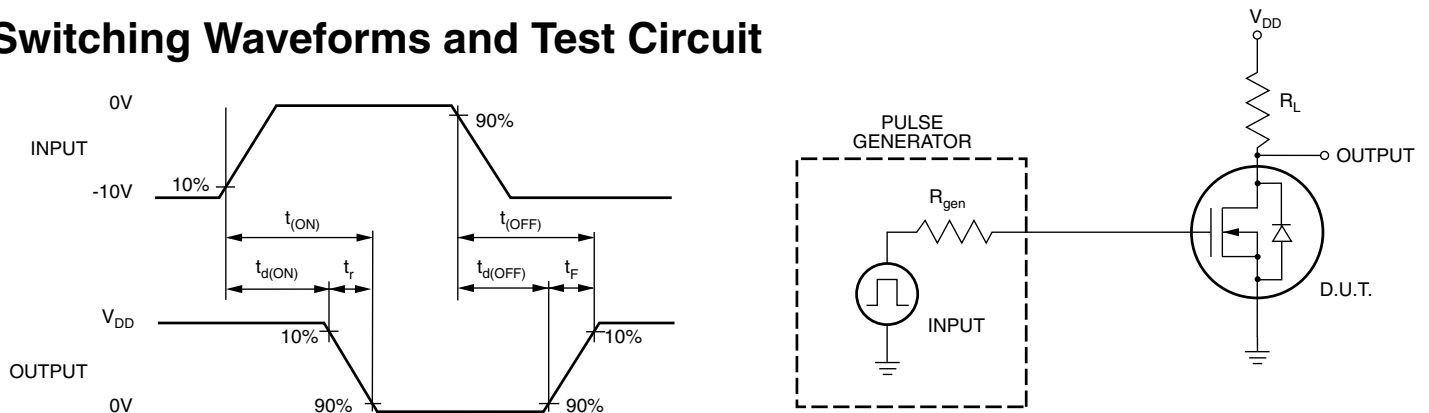

Typical Application Curves

Output Characteristics

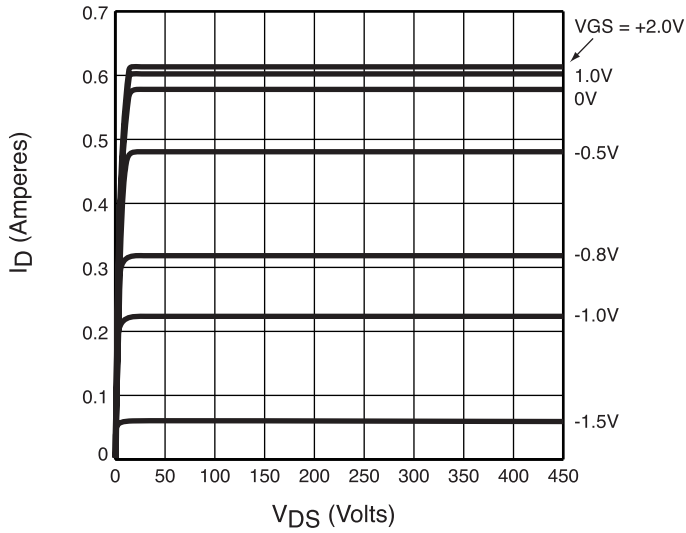

Saturation Characteristics

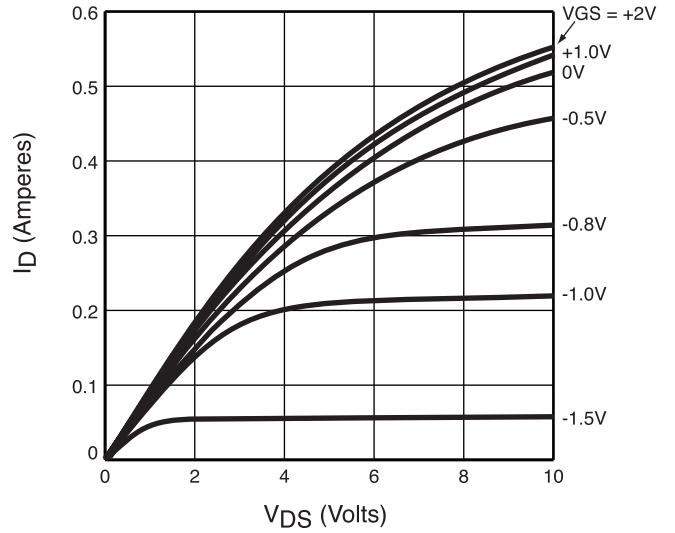

Transconductance vs. Drain Current

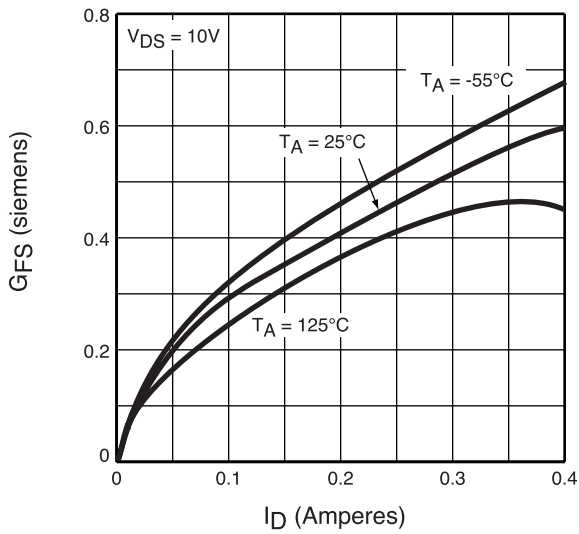

Power Dissipation vs. Ambient Temperature

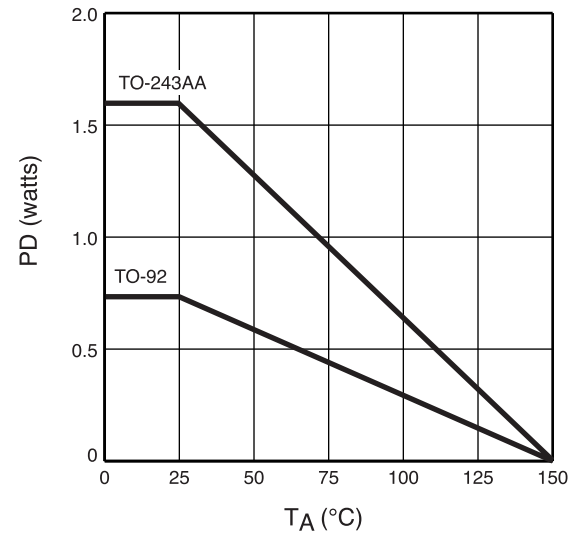

Maximum Rated Safe Operating Area

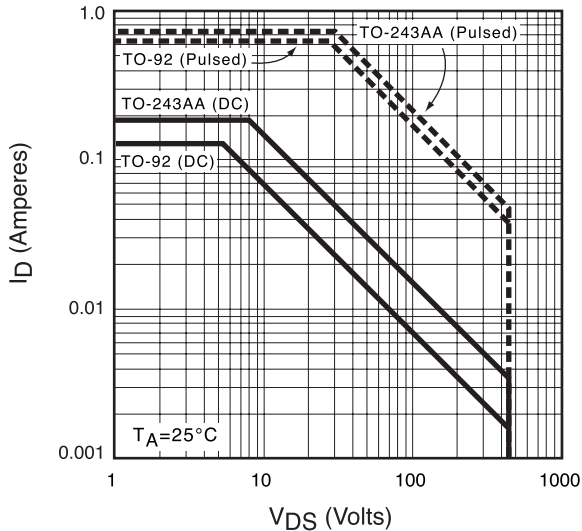

Thermal Response Characteristics

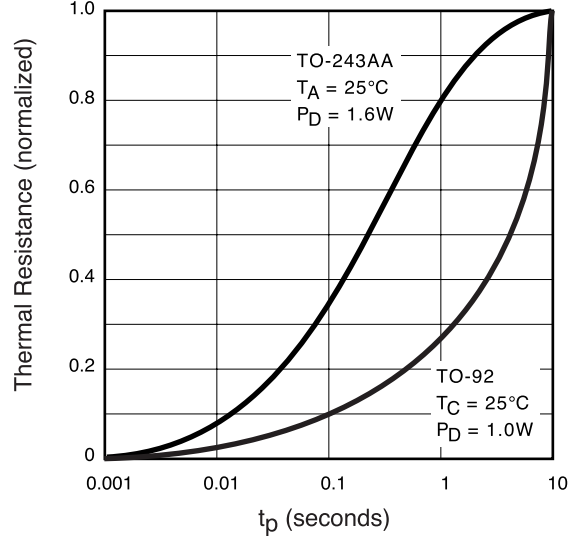

Typical Application Curves

BV_{DSS} Variation with Temperature

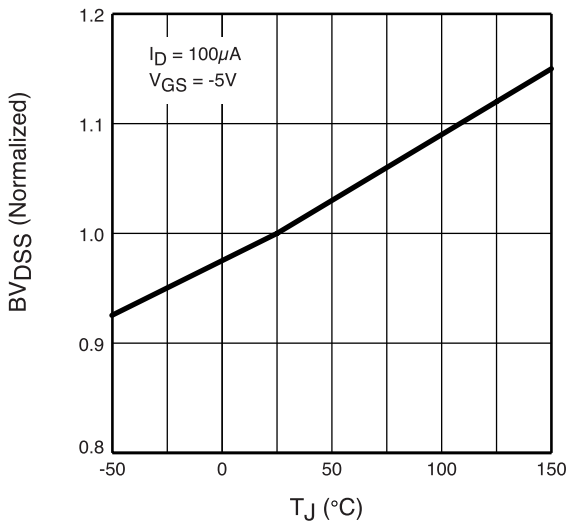

On Resistance vs. Drain Current

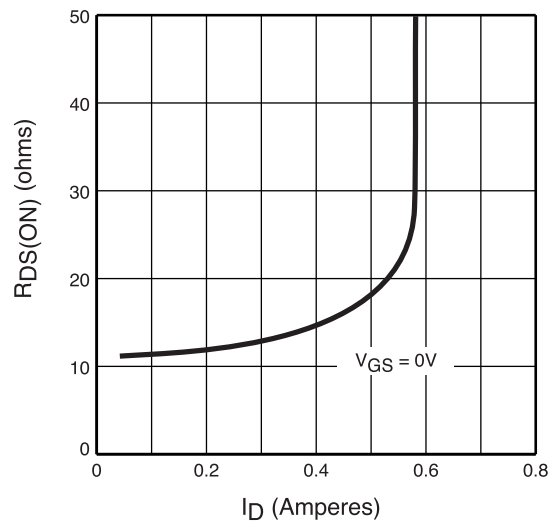

Transfer Characteristics

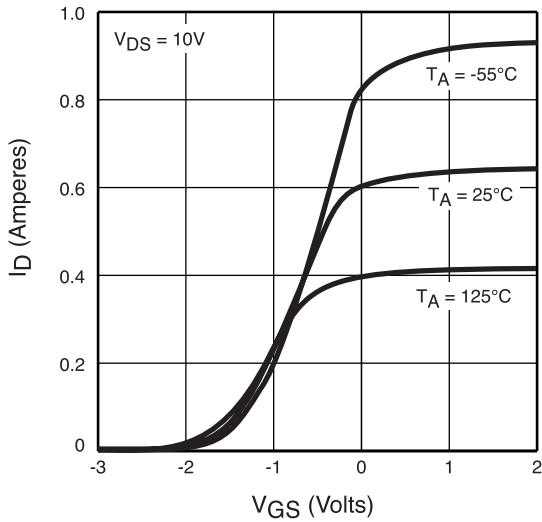

V_{GS(OFF)} and R_{DS(ON)} w/ Temperature

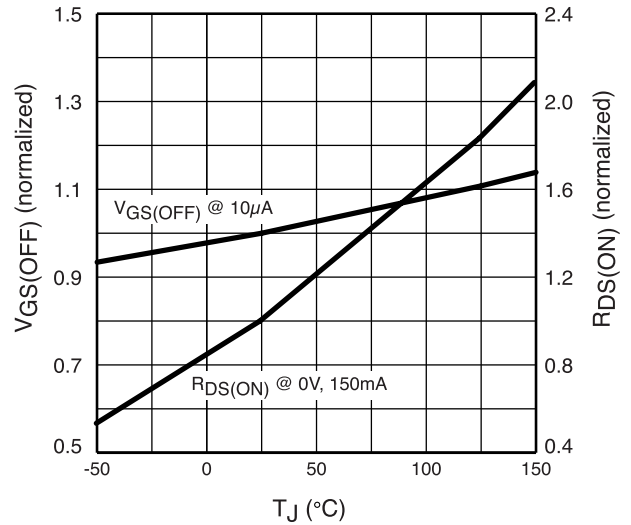

Capacitance vs. Drain Source Voltage

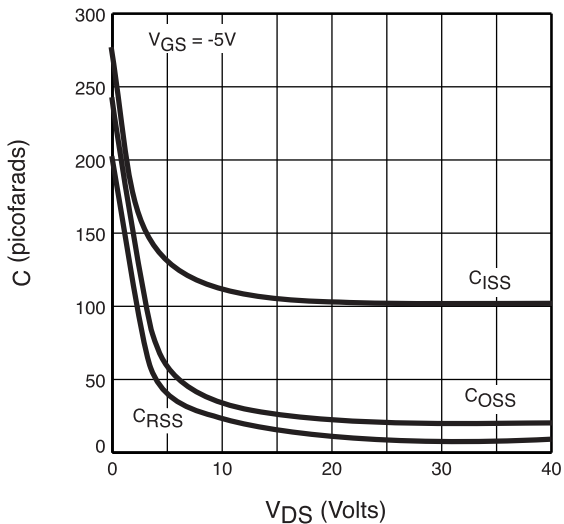

Gate Drive Dynamic Characteristics

