

SBD Type : 31DQ03L

OUTLINE DRAWING

FEATURES

- * Extremely Low Forward Voltage Drop
- * Low Power Loss, High Efficiency
- * High Surge Capability
- * 30volts trough 100volts Types Available

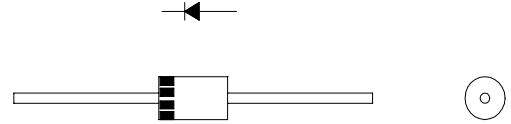

Maximum Ratings

Approx Net Weight:1.18g

Rating	Symbol	31DQ03L			Unit
Repetitive Peak Reverse Voltage	V_{RRM}	30			V
Average Rectified Output Current	I_O	1.9	$T_a=25^{\circ}C$	Half Sine Wave Resistive Load	A
		3.0	$T_a=53^{\circ}C$		
RMS Forward Current	$I_{F(RMS)}$	4.71			A
Surge Forward Current	I_{FSM}	120	Half Sine Wave,1cycle,Non-repetitive		A
Operating JunctionTemperature Range	T_{jw}	- 40 to + 150			$^{\circ}C$
Storage Temperature Range	T_{stg}	- 40 to + 150			$^{\circ}C$

Electrical • Thermal Characteristics

Characteristics	Symbol	Conditions	Min	Typ	Max	Unit
Peak Reverse Current	I_{RM}	$T_j= 25^{\circ}C, V_{RM}= V_{RRM}$	-	-	3	mA
Peak Forward Voltage	V_{FM}	$T_j= 25^{\circ}C, I_{FM}= 3 A$	-	-	0.45	V
Thermal Resistance(Junction to Ambient)	$R_{th(j-a)}$	Without Fin or P.C.Board	-	-	80	$^{\circ}C/W$
		With Fin *1	-	-	34	

*1 :20x20x1t(mm) Copper plates, L=5mm, Both Sides

31DQ_ OUTLINE DRAWING (Dimensions in mm)

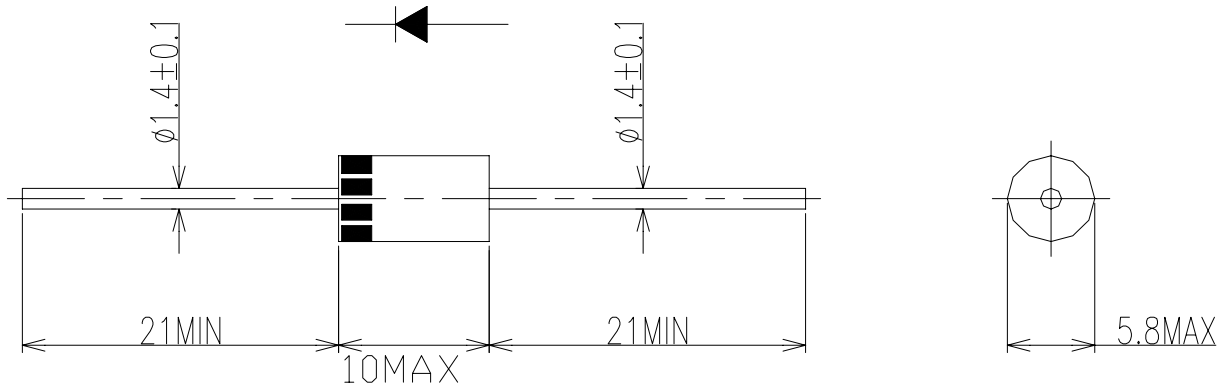

FORWARD CURRENT VS. VOLTAGE

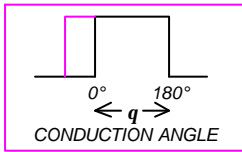
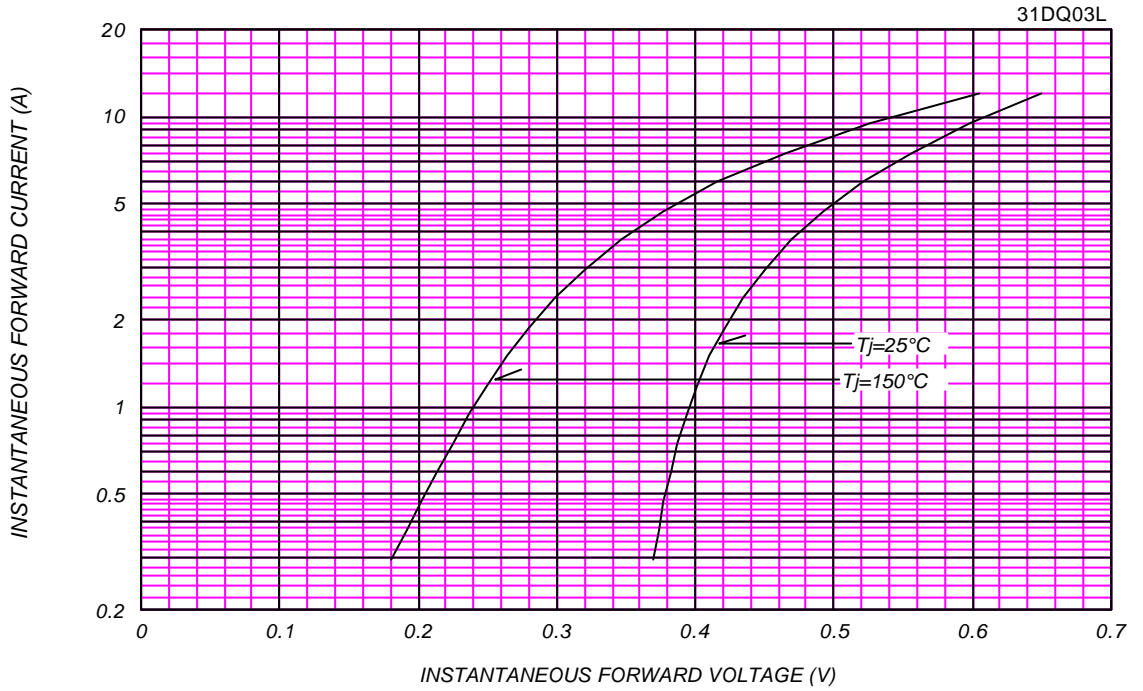

AVERAGE FORWARD POWER DISSIPATION

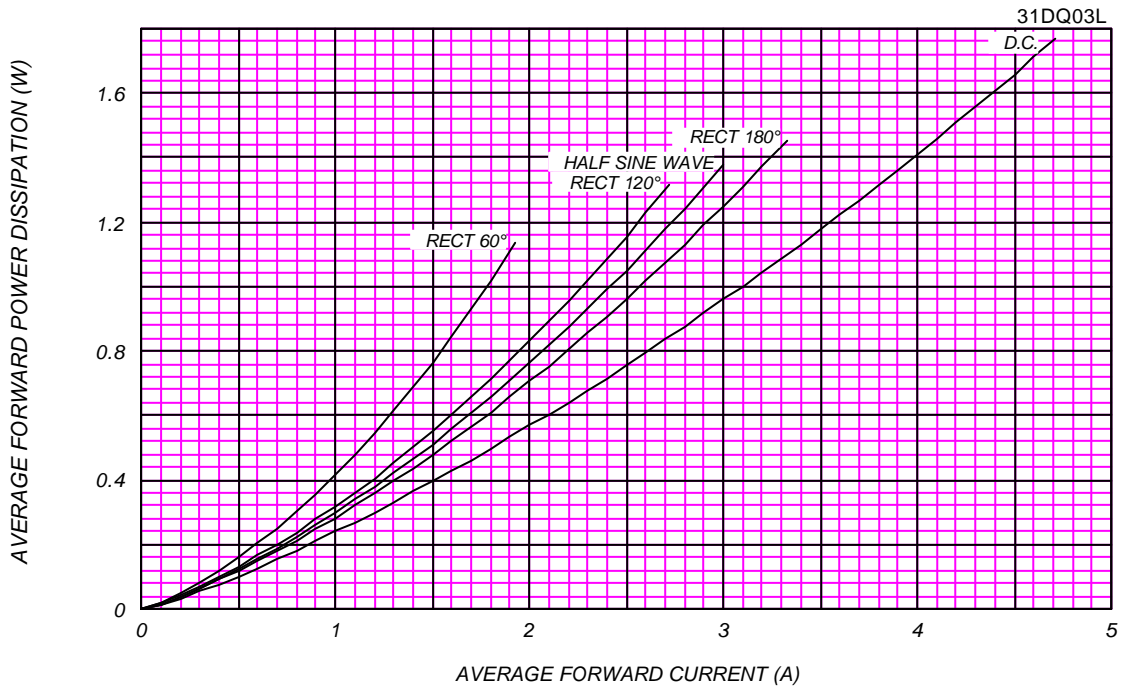

PEAK REVERSE CURRENT VS. PEAK REVERSE VOLTAGE

T_j = 150 °C

31DQ03L

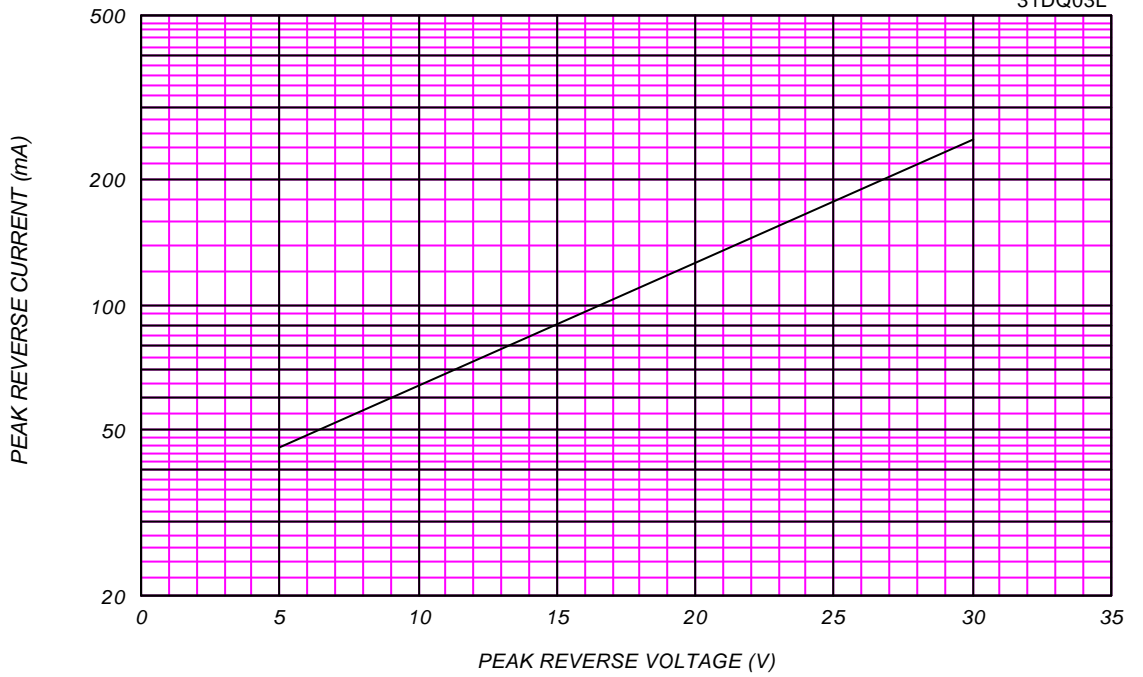

AVERAGE REVERSE POWER DISSIPATION

31DQ03L

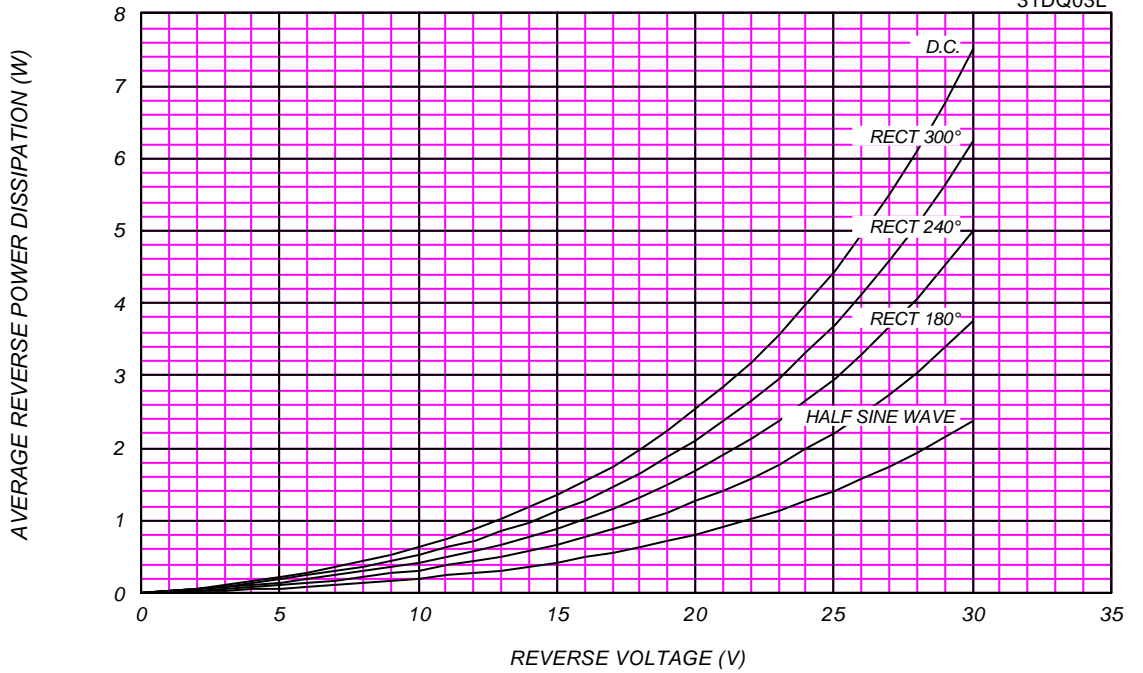

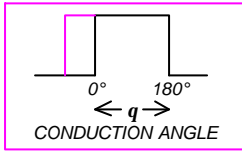

AVERAGE FORWARD CURRENT VS. AMBIENT TEMPERATURE

Without Fin or P.C. Board, $V_{RM}=30V$

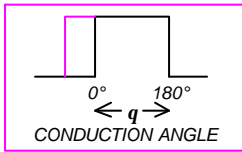
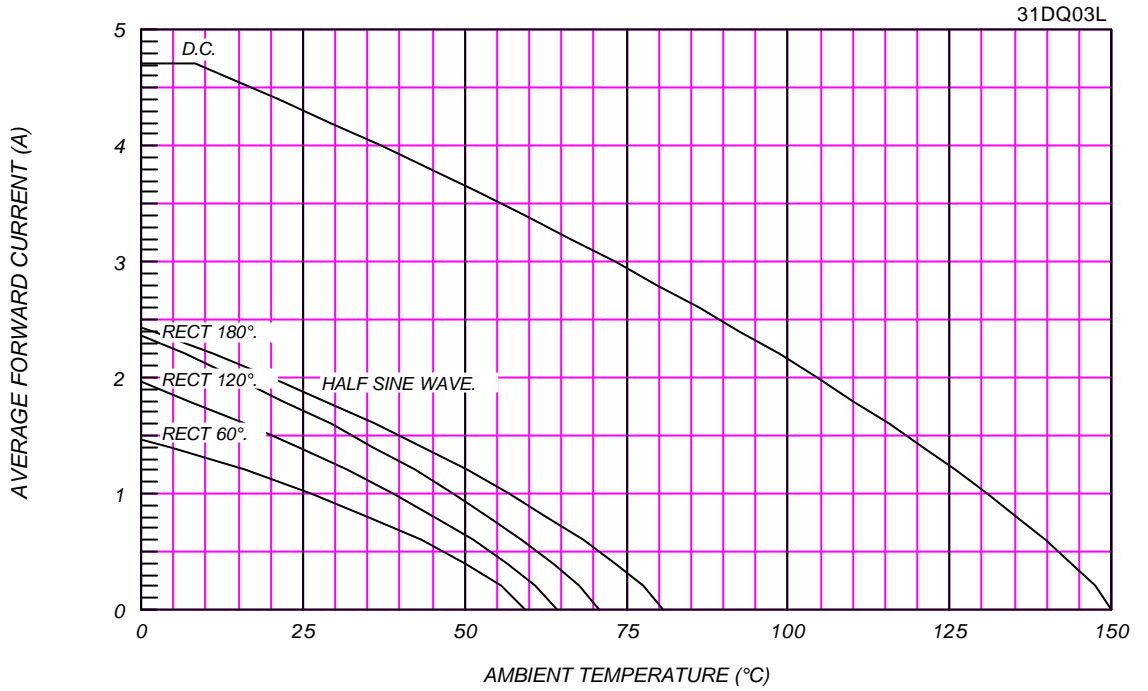

AVERAGE FORWARD CURRENT VS. AMBIENT TEMPERATURE

With Cu Fin $\times 2$ (20 \times 20 \times 1t, L=5mm, Both Sides), $V_{RM}=30V$

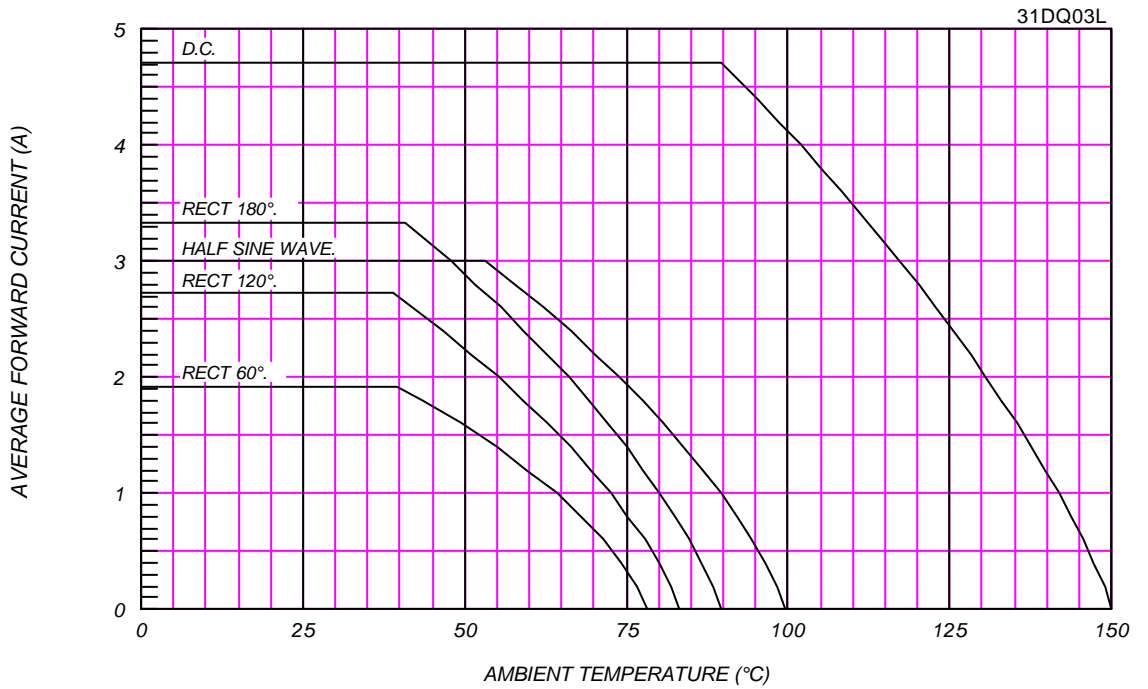

SURGE CURRENT RATINGS

f=50Hz, Half Sine Wave, Non-Repetitive, No Load

31DQ03L

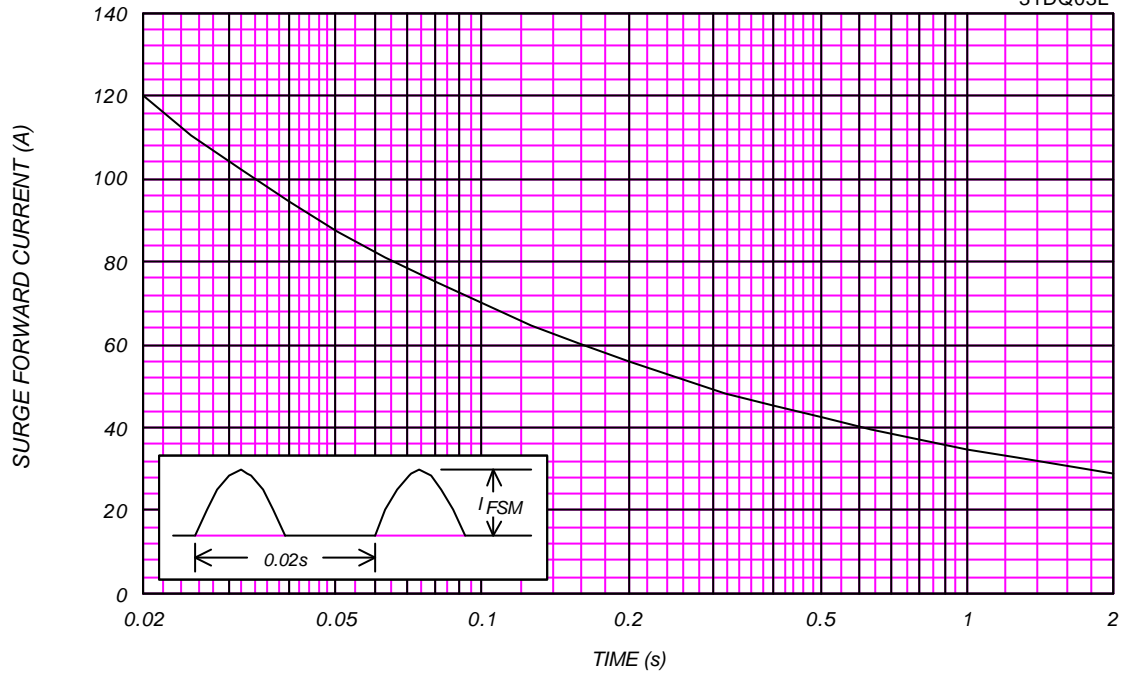

JUNCTION CAPACITANCE VS. REVERSE VOLTAGE

$T_j = 25^\circ\text{C}$, $V_m = 20\text{mV}_{RMS}$, $f = 100\text{kHz}$, Typical Value

31DQ03L

