

FAST-TRANSIENT-RESPONSE 1-A LOW-DROPOUT VOLTAGE REGULATORS

FEATURES

- 1 A Low-Dropout Voltage Regulator
- Available in 1.5-V, 1.8-V, 2.5-V, 2.7-V, 2.8-V, 3.0-V, 3.3-V, 5.0-V Fixed Output and Adjustable Versions
- Dropout Voltage Down to 230 mV at 1 A (TPS76850)
- Ultralow 85 μ A Typical Quiescent Current
- Fast Transient Response
- 2% Tolerance Over Specified Conditions for Fixed-Output Versions
- Open Drain Power Good (See TPS767xx for Power-On Reset With 200-ms Delay Option)
- 8-Pin SOIC and 20-Pin TSSOP (PWP) Package
- Thermal Shutdown Protection

DESCRIPTION

This device is designed to have a fast transient response and be stable with 10 μ F low ESR capacitors. This combination provides high performance at a reasonable cost.

PWP PACKAGE
(TOP VIEW)

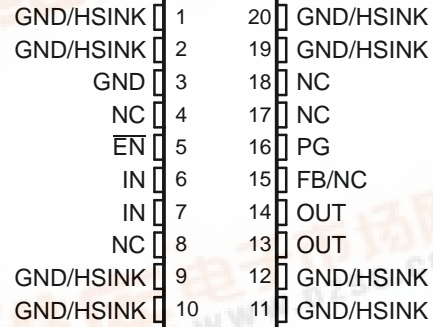

NC – No internal connection

D PACKAGE
(TOP VIEW)

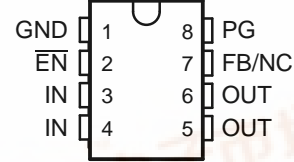

TPS76833
DROPOUT VOLTAGE
vs
FREE-AIR TEMPERATURE

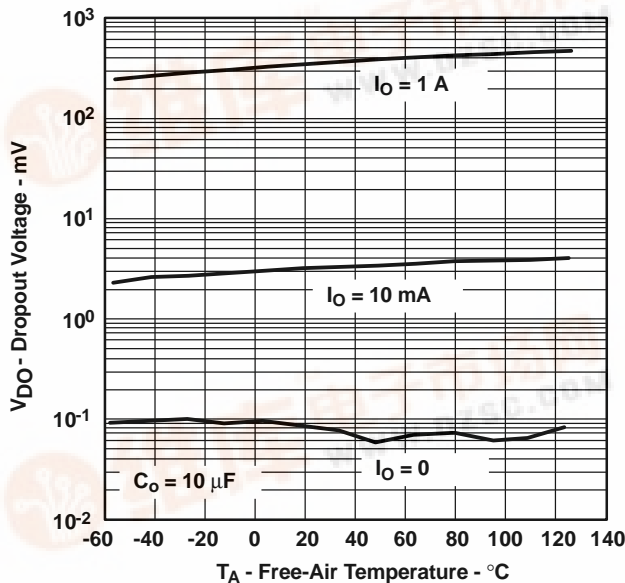

LOAD TRANSIENT RESPONSE

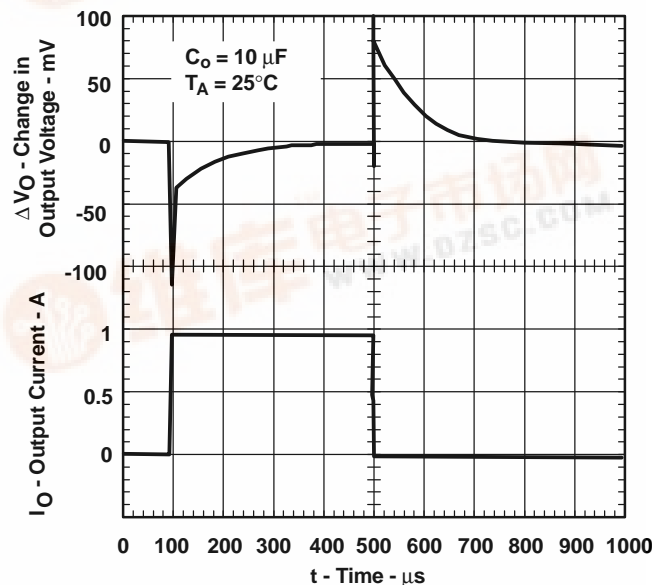

DESCRIPTION (CONTINUED)

Because the PMOS device behaves as a low-value resistor, the dropout voltage is very low (typically 230 mV at an output current of 1 A for the TPS76850) and is directly proportional to the output current. Additionally, since the PMOS pass element is a voltage-driven device, the quiescent current is very low and independent of output loading (typically 85 μ A over the full range of output current, 0 mA to 1 A). These two key specifications yield a significant improvement in operating life for battery-powered systems. This LDO family also features a sleep mode; applying a TTL high signal to $\overline{\text{EN}}$ (enable) shuts down the regulator, reducing the quiescent current to less than 1 μ A at $T_J = 25^\circ\text{C}$.

Power good (PG) is an active high output, which can be used to implement a power-on reset or a low-battery indicator.

The TPS768xx is offered in 1.5-V, 1.8-V, 2.5-V, 2.7-V, 2.8-V, 3.0-V, 3.3-V, and 5.0-V fixed-voltage versions and in an adjustable version (programmable over the range of 1.2 V to 5.5 V). Output voltage tolerance is specified as a maximum of 2% over line, load, and temperature ranges. The TPS768xx family is available in 8-pin SOIC and 20-pin PWP packages.

AVAILABLE OPTIONS

T_J	OUTPUT VOLTAGE (V)	PACKAGED DEVICES ⁽¹⁾	
	TYP	TSSOP (PWP)	SOIC (D)
40°C to 125°C	5.0	TPS76850Q	TPS76850Q
	3.3	TPS76833Q	TPS76833Q
	3.0	TPS76830Q	TPS76830Q
	2.8	TPS76828Q	TPS76828Q
	2.7	TPS76827Q	TPS76827Q
	2.5	TPS76825Q	TPS76825Q
	1.8	TPS76818Q	TPS76818Q
	1.5	TPS76815Q	TPS76815Q
	Adjustable 1.2 V to 5.5 V	TPS76801Q	TPS76801Q

(1) The TPS76801 is programmable using an external resistor divider (see application information). The D and PWP packages are available taped and reeled. Add an R suffix to the device type (e.g., TPS76801QDR).

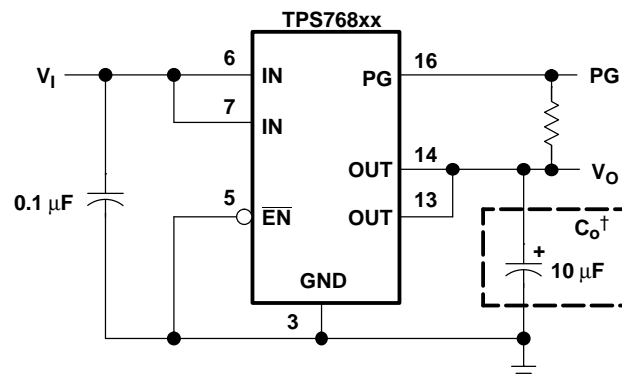

† See application information section for capacitor selection details.

Figure 1. Typical Application Configuration (For Fixed Output Options)

FUNCTIONAL BLOCK DIAGRAM—Adjustable Version

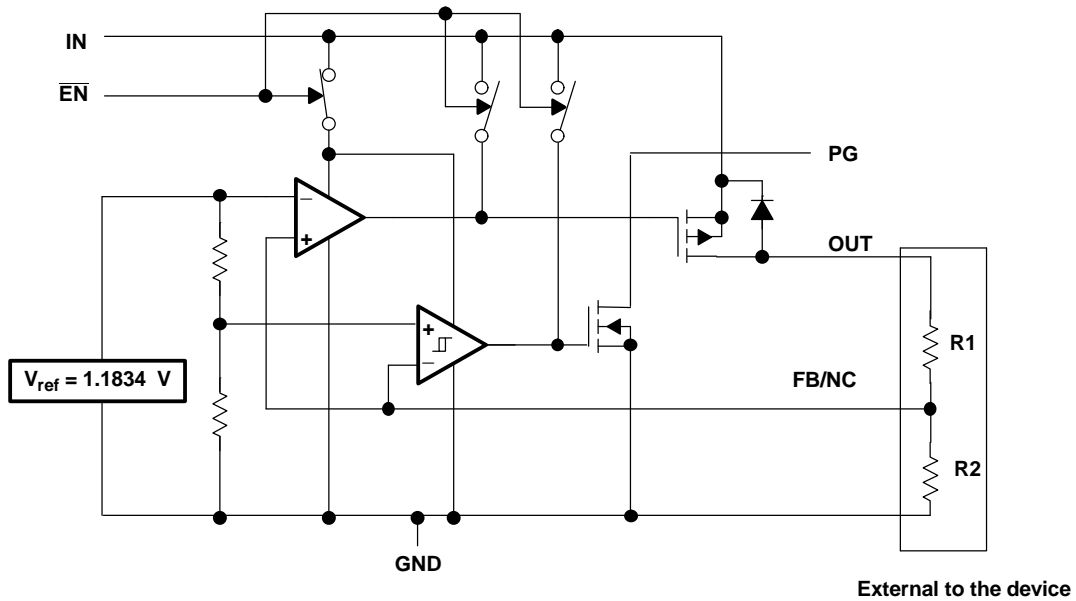

FUNCTIONAL BLOCK DIAGRAM—Fixed-Voltage Version

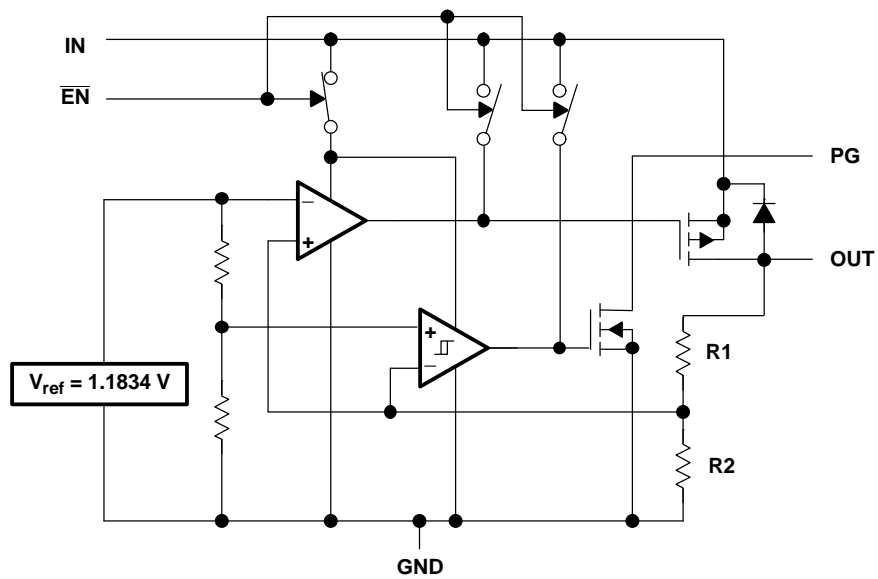

Terminal Functions

TERMINAL		I/O	DESCRIPTION
NAME	NO.		
SOIC PACKAGE			
GND	1		Regulator ground
$\overline{\text{EN}}$	2	I	Enable input
IN	3	I	Input voltage
IN	4	I	Input voltage
OUT	5	O	Regulated output voltage
OUT	6	O	Regulated output voltage
FB/NC	7	I	Feedback input voltage for adjustable device (no connect for fixed options)
PG	8	O	PG output
PWP PACKAGE			
GND/HSINK	1		Ground/heatsink
GND/HSINK	2		Ground/heatsink
GND	3		LDO ground
NC	4		No connect
$\overline{\text{EN}}$	5	I	Enable input
IN	6	I	Input
IN	7	I	Input
NC	8		No connect
GND/HSINK	9		Ground/heatsink
GND/HSINK	10		Ground/heatsink
GND/HSINK	11		Ground/heatsink
GND/HSINK	12		Ground/heatsink
Out	13	O	Regulated output voltage
Out	14	O	Regulated output voltage
FB/NC	15	I	Feedback input voltage for adjustable device (no connect for fixed options)
PG	16	O	PG output
NC	17		No connect
NC	18		No connect
GND/HSINK	19		Ground/heatsink
GND/HSINK	20		Ground/heatsink



These devices have limited built-in ESD protection. The leads should be shorted together or the device placed in conductive foam during storage or handling to prevent electrostatic damage to the MOS gates

ABSOLUTE MAXIMUM RATINGS

over operating free-air temperature range (unless otherwise noted) ⁽¹⁾

Input voltage range, V_I ⁽²⁾	-0.3 V to 13.5 V
Voltage range at \overline{EN}	-0.3 V to $V_I + 0.3$ V
Maximum PG voltage	16.5 V
Peak output current	Internally limited
Continuous total power dissipation	See dissipation rating tables
Output voltage, V_O (OUT, FB)	7 V
Operating junction temperature range, T_J	-40°C to 125°C
Storage temperature range, T_{stg}	-65°C to 150°C
ESD rating, HBM	2 kV

- (1) Stresses beyond those listed under *absolute maximum ratings* may cause permanent damage to the device. These are stress ratings only, and functional operation of the device at these or any other conditions beyond those indicated under *recommended operating conditions* is not implied. Exposure to absolute-maximum-rated conditions for extended periods may affect device reliability.
- (2) All voltage values are with respect to network terminal ground.

DISSIPATION RATING TABLE 1 - FREE-AIR TEMPERATURES

PACKAGE	AIR FLOW (CFM)	$T_A < 25^\circ\text{C}$ POWER RATING	DERATING FACTOR ABOVE $T_A = 25^\circ\text{C}$	$T_A = 70^\circ\text{C}$ POWER RATING	$T_A = 85^\circ\text{C}$ POWER RATING
D	0	568.18 mW	5.6818 mW/°C	312.5 mW	227.27 mW
	250	904.15 mW	9.0415 mW/°C	497.28 mW	361.66 mW

DISSIPATION RATING TABLE 2 - FREE-AIR TEMPERATURES

PACKAGE	AIR FLOW (CFM)	$T_A < 25^\circ\text{C}$ POWER RATING	DERATING FACTOR ABOVE $T_A = 25^\circ\text{C}$	$T_A = 70^\circ\text{C}$ POWER RATING	$T_A = 85^\circ\text{C}$ POWER RATING
PWP ⁽¹⁾	0	2.9 W	23.5 mW/°C	1.9 W	1.5 W
	300	4.3 W	34.6 mW/°C	2.8 W	2.2 W
PWP ⁽²⁾	0	3 W	23.8 mW/°C	1.9 W	1.5 W
	300	7.2 W	57.9 mW/°C	4.6 W	3.8 W

- (1) This parameter is measured with the recommended copper heat sink pattern on a 1-layer PCB, 5-in x 5-in PCB, 1 oz. copper, 2-in x 2-in coverage (4 in²).
- (2) This parameter is measured with the recommended copper heat sink pattern on an 8-layer PCB, 1.5-in x 2-in PCB, 1 oz. copper, with layers 1, 2, 3, 4, 5, 7, and 8 at 5% coverage (0.9 in²) and layers 3 and 6 at 100% coverage (6 in²). For more information, refer to TI technical brief SLMA002, available for download at www.ti.com.

RECOMMENDED OPERATING CONDITIONS

	MIN	MAX	UNIT
Input voltage, V_I ⁽¹⁾	2.7	10	V
Output voltage range, V_O	1.2	5.5	V
Output current, I_O ⁽²⁾	0	1.0	A
Operating junction temperature, T_J ⁽²⁾	40	125	°C

- (1) To calculate the minimum input voltage for your maximum output current, use the following equation: $V_{I(\min)} = V_{O(\max)} + V_{DO(\max \text{ load})}$.
- (2) Continuous current and operating junction temperature are limited by internal protection circuitry, but it is not recommended that the device operate under conditions beyond those specified in this table for extended periods of time.

ELECTRICAL CHARACTERISTICS

over recommended operating free-air temperature range, $V_I = V_{O(\text{typ})} + 1 \text{ V}$, $I_O = 1 \text{ mA}$, $\overline{\text{EN}} = 0 \text{ V}$, $C_O = 10 \mu\text{F}$ (unless otherwise noted)

PARAMETER		TEST CONDITIONS	MIN	TYP	MAX	UNIT	
Output voltage (10 μA to 1 A load) ⁽¹⁾	TPS76801	$5.5 \text{ V} \geq V_O \geq 1.5 \text{ V}$, $T_J = 25^\circ\text{C}$		V_O		V	
		$5.5 \text{ V} \geq V_O \geq 1.5 \text{ V}$, $T_J = -40^\circ\text{C}$ to 125°C	$0.98V_O$		$1.02V_O$		
	TPS76815	$T_J = 25^\circ\text{C}$, $2.7 \text{ V} < V_{\text{IN}} < 10 \text{ V}$		1.5			
		$T_J = -40^\circ\text{C}$ to 125°C , $2.7 \text{ V} < V_{\text{IN}} < 10 \text{ V}$	1.470		1.530		
	TPS76818	$T_J = 25^\circ\text{C}$, $2.8 \text{ V} < V_{\text{IN}} < 10 \text{ V}$		1.8			
		$T_J = -40^\circ\text{C}$ to 125°C , $2.8 \text{ V} < V_{\text{IN}} < 10 \text{ V}$	1.764		1.836		
	TPS76825	$T_J = 25^\circ\text{C}$, $3.5 \text{ V} < V_{\text{IN}} < 10 \text{ V}$		2.5			
		$T_J = -40^\circ\text{C}$ to 125°C , $3.5 \text{ V} < V_{\text{IN}} < 10 \text{ V}$	2.450		2.550		
	TPS76827	$T_J = 25^\circ\text{C}$, $3.7 \text{ V} < V_{\text{IN}} < 10 \text{ V}$		2.7			
		$T_J = -40^\circ\text{C}$ to 125°C , $3.7 \text{ V} < V_{\text{IN}} < 10 \text{ V}$	2.646		2.754		
	TPS76828	$T_J = 25^\circ\text{C}$, $3.8 \text{ V} < V_{\text{IN}} < 10 \text{ V}$		2.8			
		$T_J = -40^\circ\text{C}$ to 125°C , $3.8 \text{ V} < V_{\text{IN}} < 10 \text{ V}$	2.744		2.856		
	TPS76830	$T_J = 25^\circ\text{C}$, $4 \text{ V} < V_{\text{IN}} < 10 \text{ V}$		3.0			
		$T_J = -40^\circ\text{C}$ to 125°C , $4 \text{ V} < V_{\text{IN}} < 10 \text{ V}$	2.940		3.060		
	TPS76833	$T_J = 25^\circ\text{C}$, $4.3 \text{ V} < V_{\text{IN}} < 10 \text{ V}$		3.3			
		$T_J = -40^\circ\text{C}$ to 125°C , $4.3 \text{ V} < V_{\text{IN}} < 10 \text{ V}$	3.234		3.366		
TPS76850	$T_J = 25^\circ\text{C}$, $6 \text{ V} < V_{\text{IN}} < 10 \text{ V}$		5.0				
	$T_J = -40^\circ\text{C}$ to 125°C , $6 \text{ V} < V_{\text{IN}} < 10 \text{ V}$	4.900		5.100			
Quiescent current (GND current) $\overline{\text{EN}} = 0 \text{ V}$ ⁽¹⁾		$10 \mu\text{A} < I_O < 1 \text{ A}$, $T_J = 25^\circ\text{C}$		85		μA	
		$I_O = 1 \text{ A}$, $T_J = -40^\circ\text{C}$ to 125°C			125		
Output voltage line regulation ($\Delta V_O/V_O$) ⁽¹⁾⁽²⁾		$V_O + 1 \text{ V} < V_I \leq 10 \text{ V}$, $T_J = 25^\circ\text{C}$		0.01		%/V	
Load regulation				3		mV	
Output noise voltage (TPS76818)		$\text{BW} = 200 \text{ Hz}$ to 100 kHz , $C_O = 10 \mu\text{F}$, $I_C = 1 \text{ A}$, $T_J = 25^\circ\text{C}$		55		μVrms	
Output current limit		$V_O = 0 \text{ V}$	1.2	1.7	2	A	
Thermal shutdown junction temperature				150		$^\circ\text{C}$	
Standby current		$\overline{\text{EN}} = V_I$, $T_J = 25^\circ\text{C}$, $2.7 \text{ V} < V_I < 10 \text{ V}$		1		μA	
		$\overline{\text{EN}} = V_I$, $T_J = -40^\circ\text{C}$ to 125°C , $2.7 \text{ V} < V_I < 10 \text{ V}$			10	μA	
FB input current	TPS76801	$\text{FB} = 1.5 \text{ V}$		2		nA	
High level enable input voltage			1.7			V	
Low level enable input voltage					0.9	V	
Power supply ripple rejection ⁽¹⁾		$f = 1 \text{ KHz}$, $C_O = 10 \mu\text{F}$, $T_J = 25^\circ\text{C}$		60		dB	
PG	Minimum input voltage for valid PG	$I_{O(\text{PG})} = 300 \mu\text{A}$		1.1		V	
	Trip threshold voltage	V_O decreasing	92		98	% V_O	
	Hysteresis voltage	Measured at V_O		0.5		% V_O	
	Output low voltage	$V_I = 2.7 \text{ V}$, $I_{O(\text{PG})} = 1 \text{ mA}$		0.15	0.4	V	
	Leakage current	$V_{(\text{PG})} = 5 \text{ V}$			1	μA	

(1) Minimum IN operating voltage is 2.7 V or $V_{O(\text{typ})} + 1 \text{ V}$, whichever is greater. Maximum IN voltage 10 V.

(2) If $V_O \leq 1.8 \text{ V}$ then $V_{\text{Imax}} = 10 \text{ V}$, $V_{\text{Imin}} = 2.7 \text{ V}$: $\text{Line Reg. (mV)} = (\% / \text{V}) \times V_O \frac{(V_{\text{Imax}} - 2.7 \text{ V})}{100} \times 1000$
 If $V_O \geq 2.5 \text{ V}$ then $V_{\text{Imax}} = 10 \text{ V}$, $V_{\text{Imin}} = V_O + 1 \text{ V}$: $\text{Line Reg. (mV)} = (\% / \text{V}) \times V_O \frac{(V_{\text{Imax}} - (V_O + 1 \text{ V}))}{100} \times 1000$

ELECTRICAL CHARACTERISTICS (continued)

over recommended operating free-air temperature range, $V_I = V_{O(\text{typ})} + 1 \text{ V}$, $I_O = 1 \text{ mA}$, $\overline{\text{EN}} = 0 \text{ V}$, $C_O = 10 \mu\text{F}$ (unless otherwise noted)

PARAMETER		TEST CONDITIONS	MIN	TYP	MAX	UNIT
Input current ($\overline{\text{EN}}$)		$\overline{\text{EN}} = 0 \text{ V}$	1	0	1	μA
		$\overline{\text{EN}} = V_I$	1		1	
Dropout voltage ⁽³⁾	TPS76828	$I_O = 1 \text{ A}$, $T_J = 25^\circ\text{C}$		500		mV
		$I_O = 1 \text{ A}$, $T_J = -40^\circ\text{C}$ to 125°C			825	
	TPS76830	$I_O = 1 \text{ A}$, $T_J = 25^\circ\text{C}$		450		
		$I_O = 1 \text{ A}$, $T_J = -40^\circ\text{C}$ to 125°C			675	
	TPS76833	$I_O = 1 \text{ A}$, $T_J = 25^\circ\text{C}$		350		
		$I_O = 1 \text{ A}$, $T_J = -40^\circ\text{C}$ to 125°C			575	
	TPS76850	$I_O = 1 \text{ A}$, $T_J = 25^\circ\text{C}$		230		
		$I_O = 1 \text{ A}$, $T_J = -40^\circ\text{C}$ to 125°C		380		

(3) I_N voltage equals $V_{O(\text{typ})} - 100 \text{ mV}$; TPS76801 output voltage set to 3.3 V nominal with external resistor divider. TPS76815, TPS76818, TPS76825, and TPS76827 dropout voltage limited by input voltage range limitations (i.e., TPS76830 input voltage needs to drop to 2.9 V for purpose of this test).

Table of Graphs

			FIGURE
V_O	Output voltage	vs Output current	2, 3, 4
		vs Free-air temperature	5, 6, 7
	Ground current	vs Free-air temperature	8, 9
	Power supply ripple rejection	vs Frequency	10
	Output spectral noise density	vs Frequency	11
	Input voltage (min)	vs Output voltage	12
Z_o	Output impedance	vs Frequency	13
V_{DO}	Dropout voltage	vs Free-air temperature	14
	Line transient response		15, 17
	Load transient response		16, 18
V_O	Output voltage	vs Time	19
	Dropout voltage	vs Input voltage	20
	Equivalent series resistance (ESR)	vs Output current	22 - 25

TYPICAL CHARACTERISTICS

**TPS76833
OUTPUT VOLTAGE
vs
OUTPUT CURRENT**

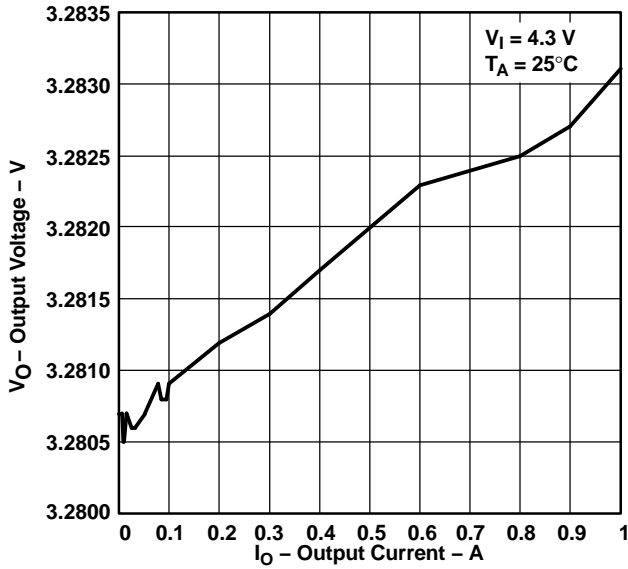

Figure 2.

**TPS76815
OUTPUT VOLTAGE
vs
OUTPUT CURRENT**

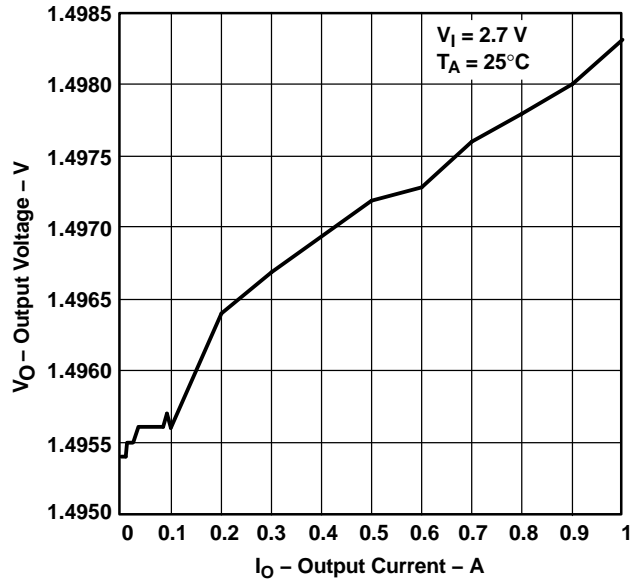

Figure 3.

**TPS76825
OUTPUT VOLTAGE
vs
OUTPUT CURRENT**

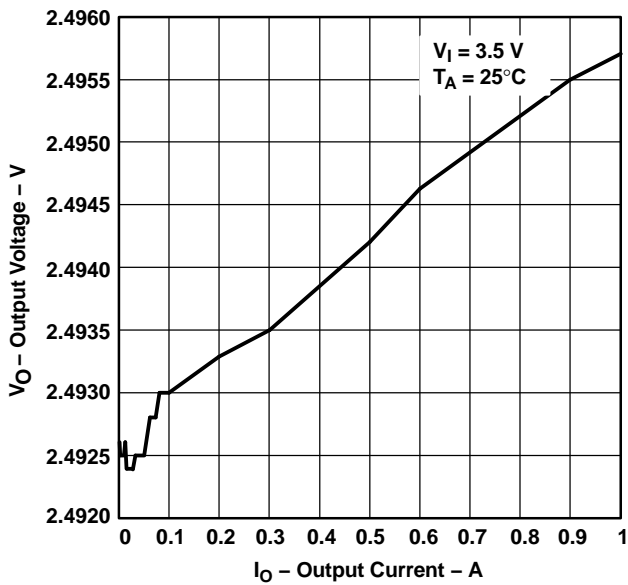

Figure 4.

**TPS76833
OUTPUT VOLTAGE
vs
FREE-AIR TEMPERATURE**

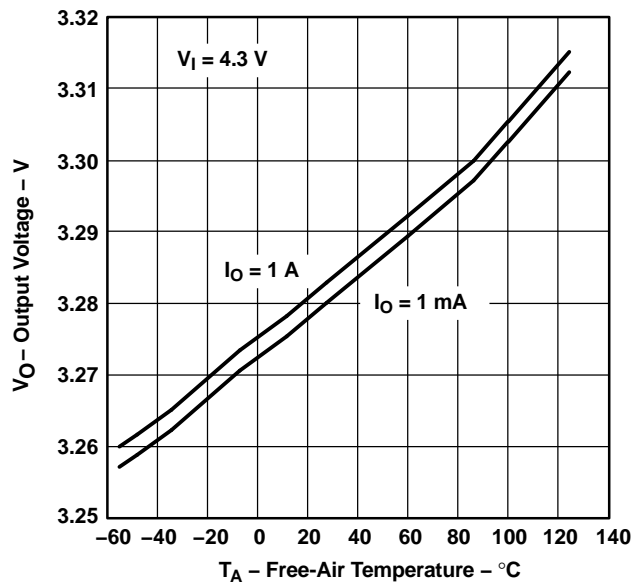

Figure 5.

TYPICAL CHARACTERISTICS (continued)

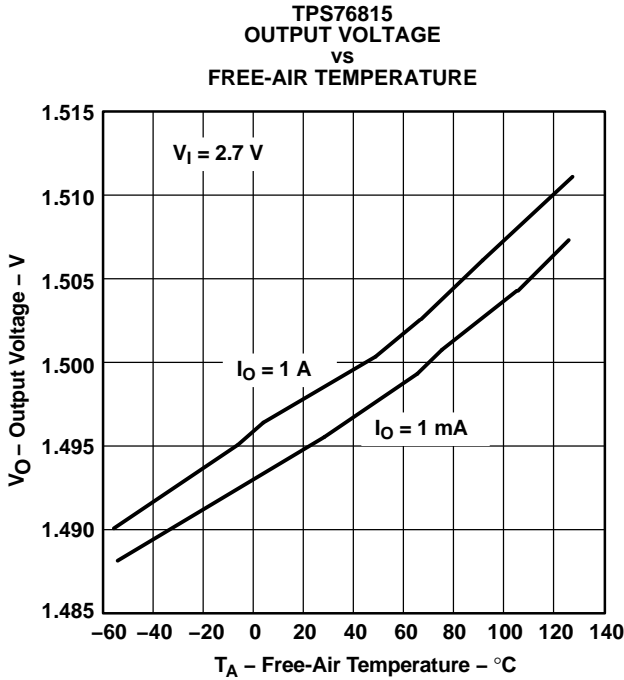

Figure 6.

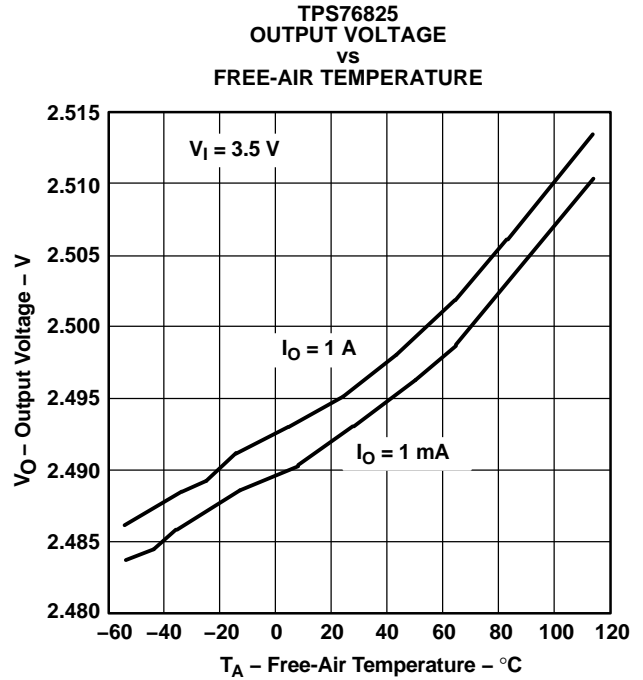

Figure 7.

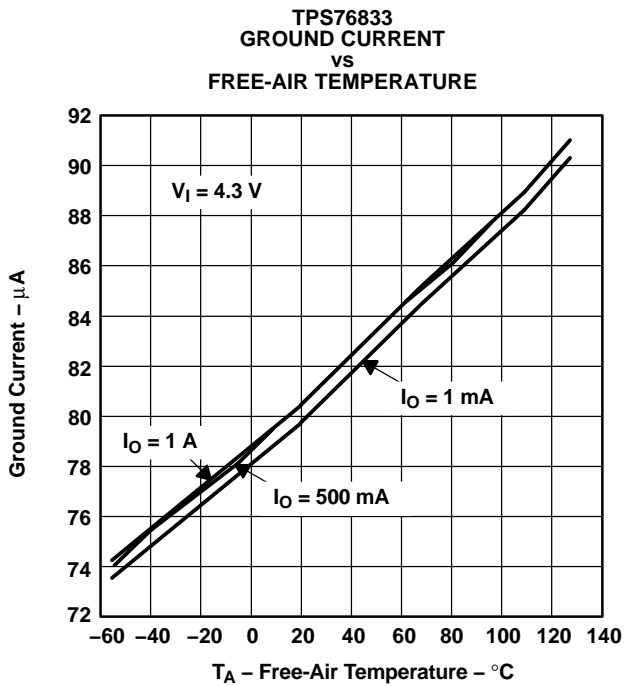

Figure 8.

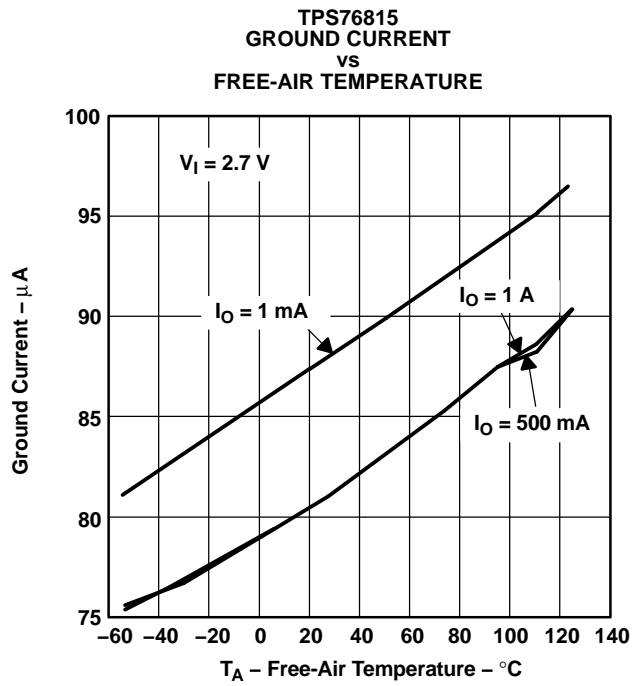

Figure 9.

TYPICAL CHARACTERISTICS (continued)

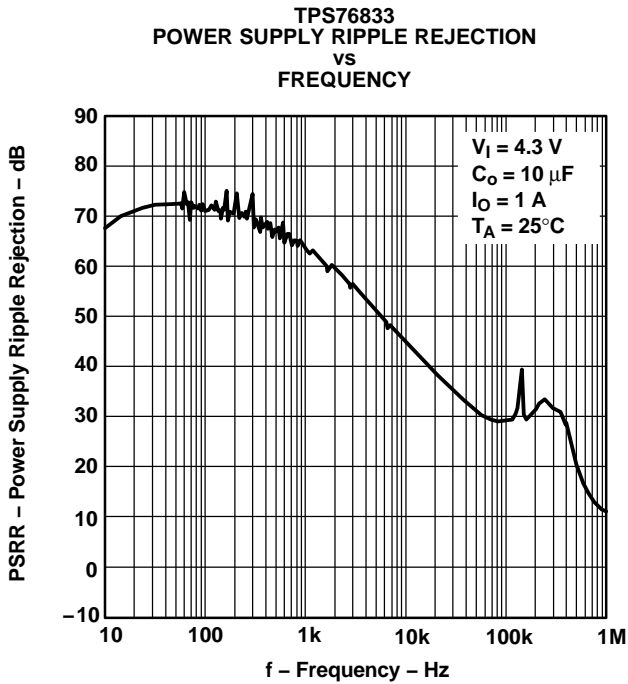

Figure 10.

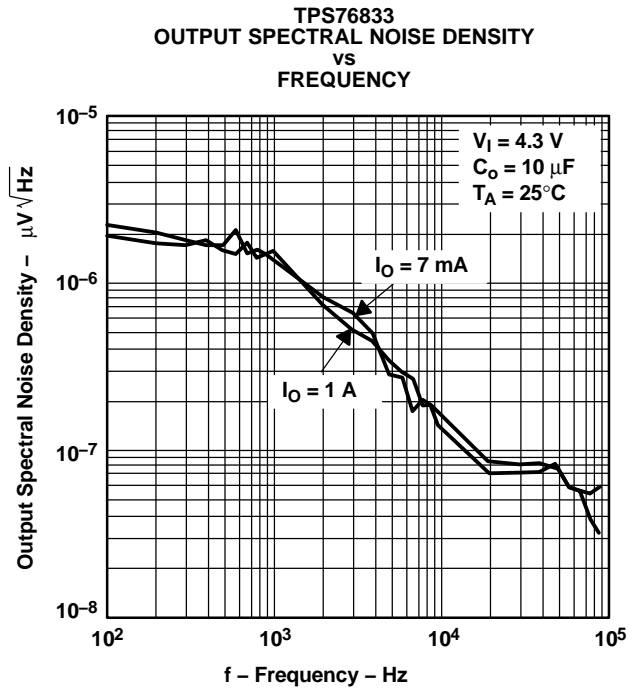

Figure 11.

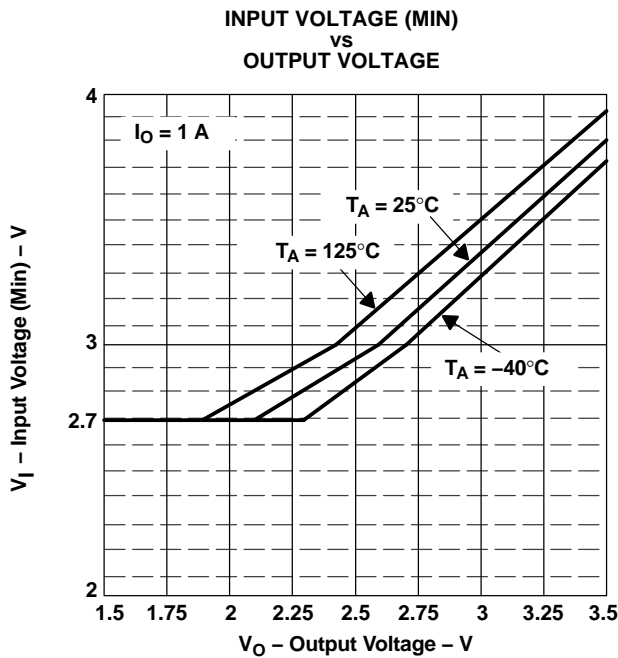

Figure 12.

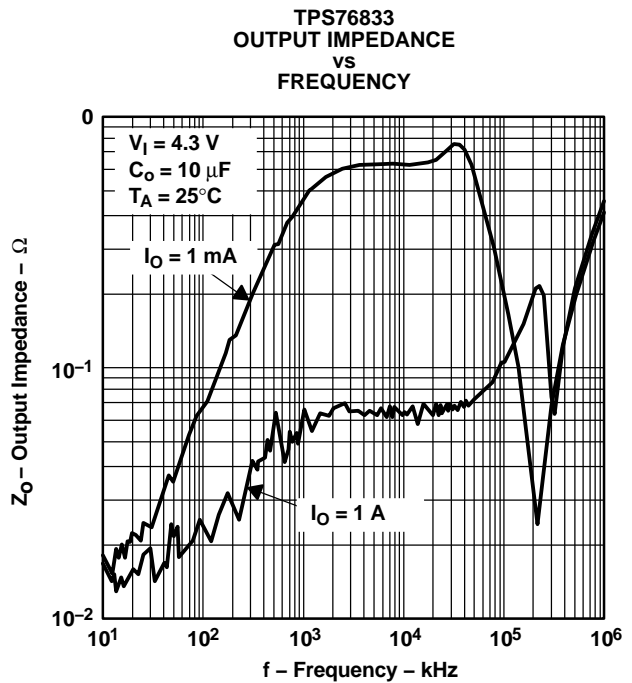

Figure 13.

TYPICAL CHARACTERISTICS (continued)

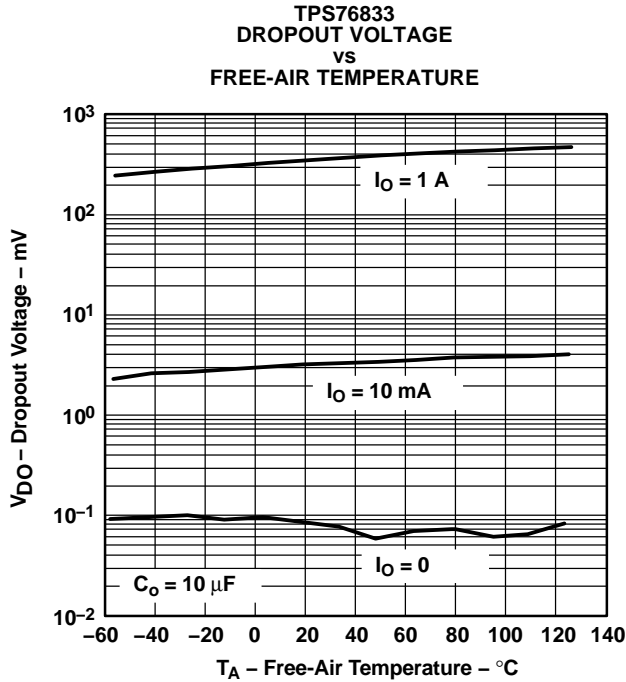

Figure 14.

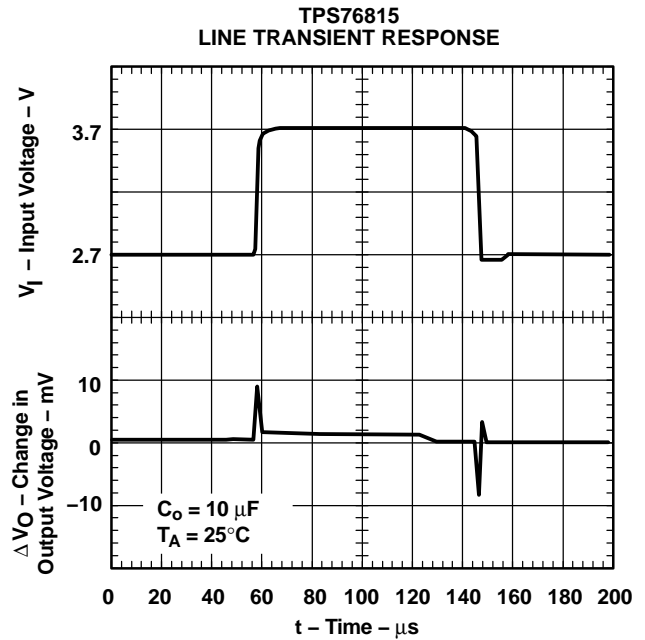

Figure 15.

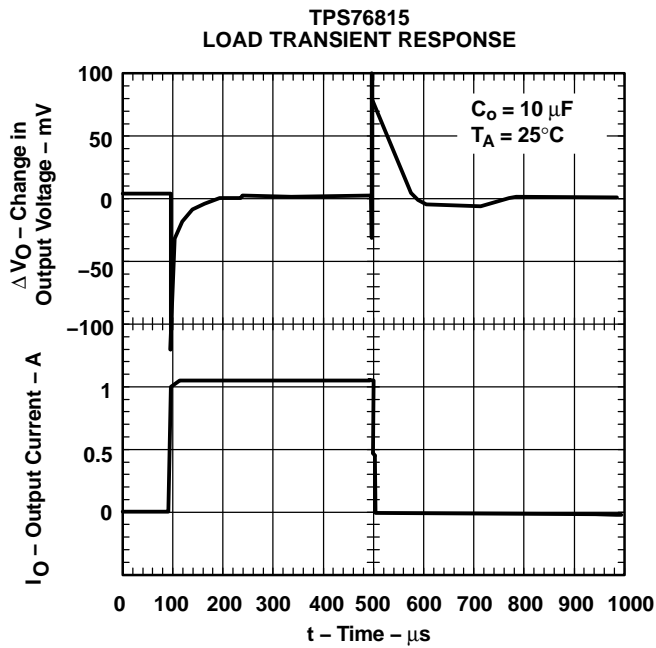

Figure 16.

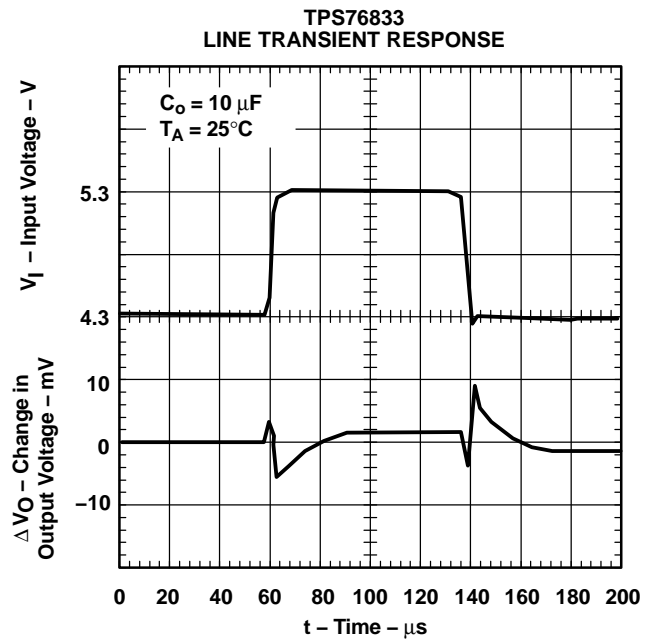
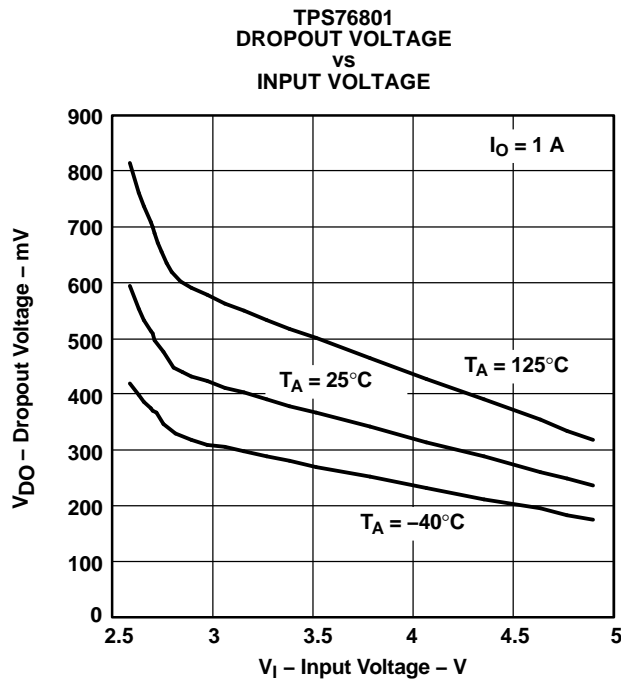
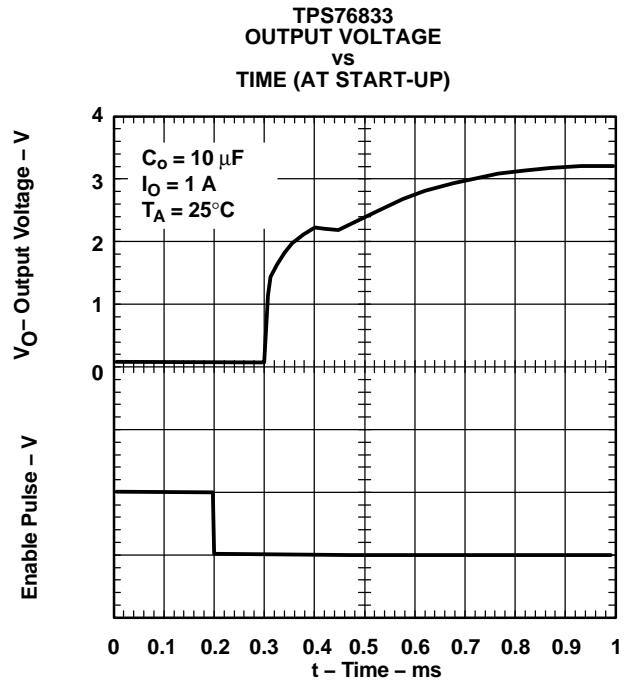
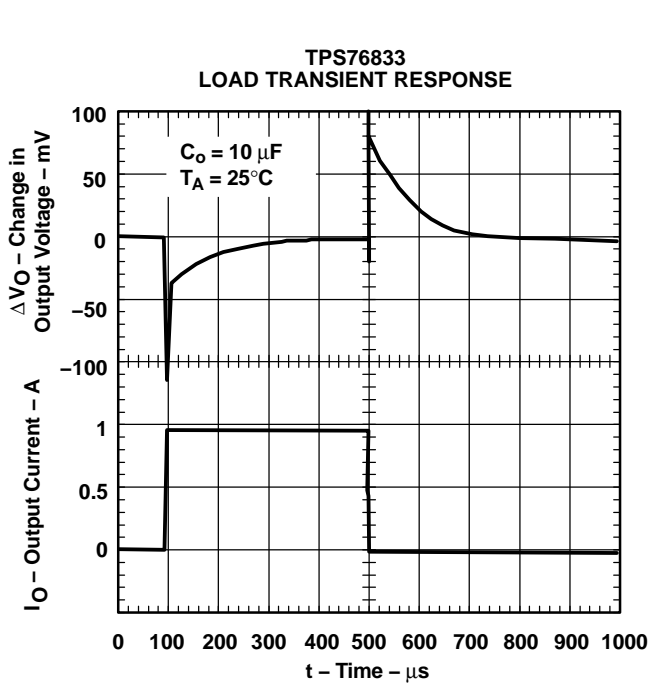
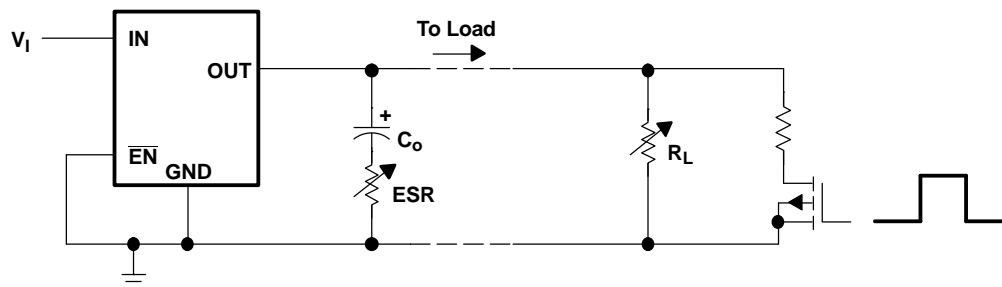

Figure 17.

TYPICAL CHARACTERISTICS (continued)



TYPICAL CHARACTERISTICS (continued)



**Figure 21. Test Circuit for Typical Regions of Stability (Figure 22 through Figure 25)
(Fixed Output Options)**

Equivalent series resistance (ESR) refers to the total series resistance, including the ESR of the capacitor, any series resistance added externally, and PWB trace resistance to C_O .

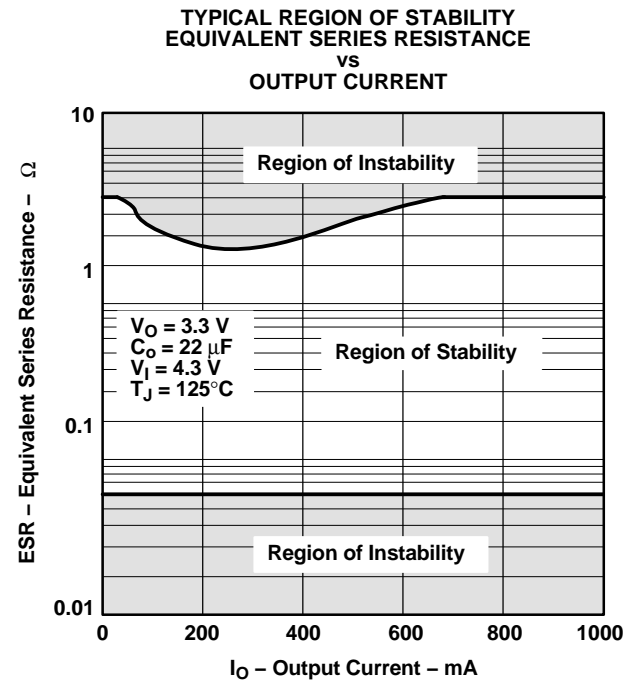
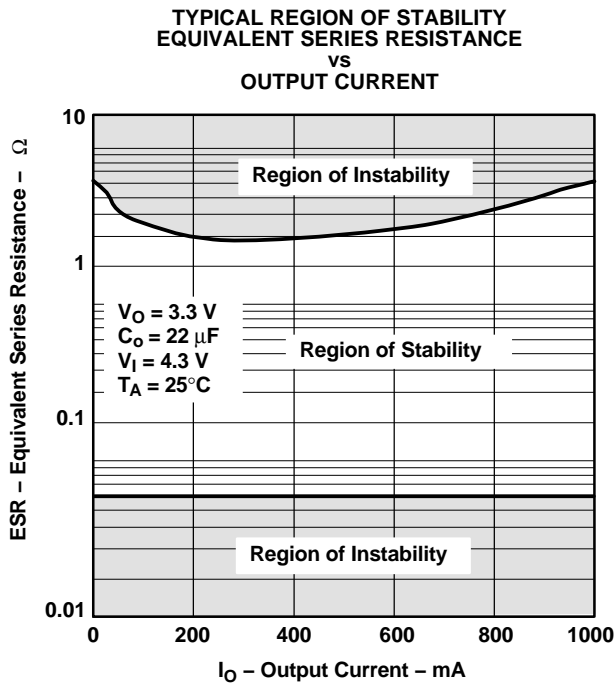
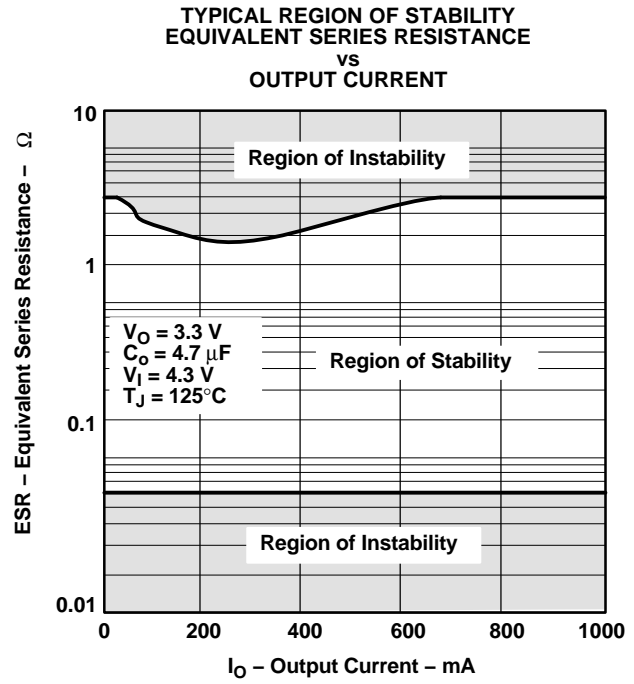
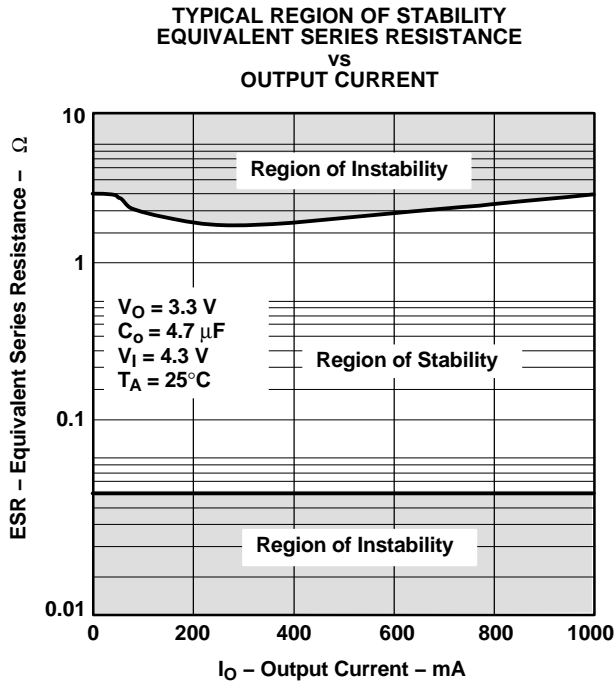

APPLICATION INFORMATION

The TPS768xx family includes eight fixed-output voltage regulators (1.5 V, 1.8 V, 2.5 V, 2.7 V, 2.8 V, 3.0 V, 3.3 V, and 5.0 V), and offers an adjustable device, the TPS76801 (adjustable from 1.2 V to 5.5 V).

DEVICE OPERATION

The TPS768xx features very low quiescent current, which remains virtually constant even with varying loads. Conventional LDO regulators use a pnp pass element, the base current of which is directly proportional to the load current through the regulator ($I_B = I_C/\beta$). The TPS768xx uses a PMOS transistor to pass current; because the gate of the PMOS is voltage driven, operating current is low and invariable over the full load range.

Another pitfall associated with the pnp-pass element is its tendency to saturate when the device goes into dropout. The resulting drop in β forces an increase in I_B to maintain the load. During power up, this translates to large start-up currents. Systems with limited supply current may fail to start up. In battery-powered systems, it means rapid battery discharge when the voltage decays below the minimum required for regulation. The TPS768xx quiescent current remains low even when the regulator drops out, eliminating both problems.

The TPS768xx family also features a shutdown mode that places the output in the high-impedance state (essentially equal to the feedback-divider resistance) and reduces quiescent current to 2 μ A. If the shutdown feature is not used, \overline{EN} should be tied to ground.

MINIMUM LOAD REQUIREMENTS

The TPS768xx family is stable even at zero load; no minimum load is required for operation.

FB - PIN CONNECTION (ADJUSTABLE VERSION ONLY)

The FB pin is an input pin to sense the output voltage and close the loop for the adjustable option. The output voltage is sensed through a resistor divider network to close the loop as shown in Figure 27. Normally, this connection should be as short as possible; however, the connection can be made near a critical circuit to improve performance at that point. Internally, FB connects to a high-impedance wide-bandwidth amplifier and noise pickup feeds through to the regulator output. Routing the FB connection to minimize/avoid noise pickup is essential.

EXTERNAL CAPACITOR REQUIREMENTS

An input capacitor is not usually required; however, a ceramic bypass capacitor (0.047 μ F or larger) improves load transient response and noise rejection if the TPS768xx is located more than a few inches from the power supply. A higher-capacitance electrolytic capacitor may be necessary if large (hundreds of milliamps) load transients with fast rise times are anticipated.

Like all low dropout regulators, the TPS768xx requires an output capacitor connected between OUT and GND to stabilize the internal control loop. The minimum recommended capacitance value is 10 μ F and the ESR (equivalent series resistance) must be between 60 m Ω and 1.5 Ω . Capacitor values 10 μ F or larger are acceptable, provided the ESR is less than 1.5 Ω . Solid tantalum electrolytic, aluminum electrolytic, and multilayer ceramic capacitors are all suitable, provided they meet the requirements described above. Most of the commercially available 10 μ F surface-mount ceramic capacitors, including devices from Sprague and Kemet, meet the ESR requirements stated above.

APPLICATION INFORMATION (continued)

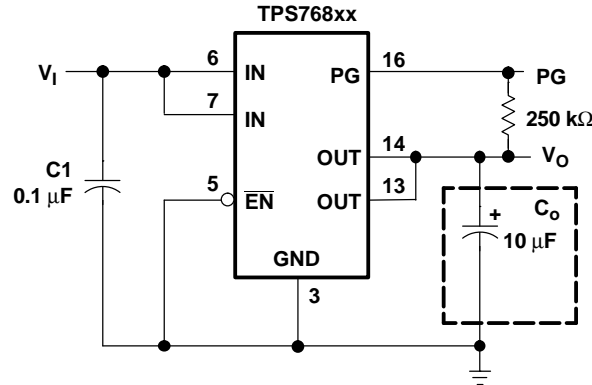

Figure 26. Typical Application Circuit (Fixed Versions)

The output voltage of the TPS76801 adjustable regulator is programmed using an external resistor divider as shown in Figure 27. The output voltage is calculated using:

$$V_O = V_{ref} \times \left(1 + \frac{R1}{R2} \right)$$

where:

$$V_{ref} = 1.1834 \text{ V typ (the internal reference voltage)} \tag{1}$$

Resistors R1 and R2 should be chosen for approximately 50-μA divider current. Lower value resistors can be used but offer no inherent advantage and waste more power. Higher values should be avoided as leakage currents at FB increase the output voltage error. The recommended design procedure is to choose R2 = 30.1 kΩ to set the divider current at 50 μA and then calculate R1 using:

$$R1 = \left(\frac{V_O}{V_{ref}} - 1 \right) \times R2 \tag{2}$$

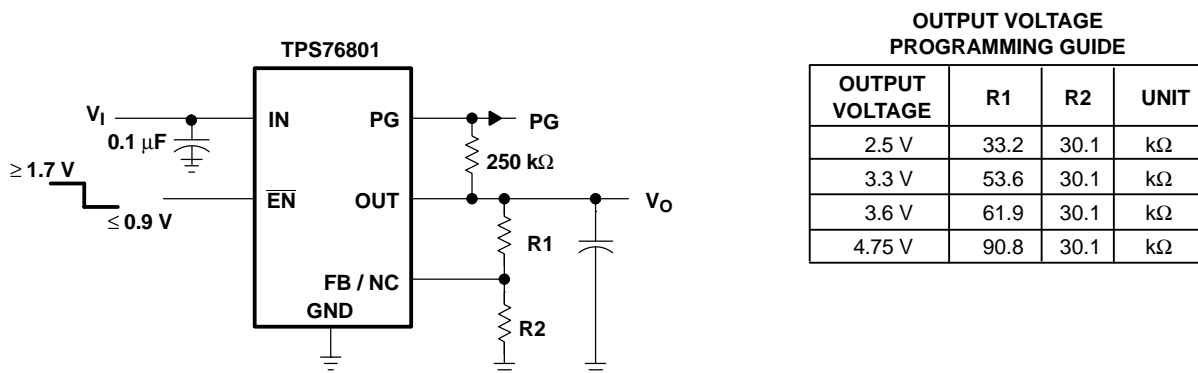

Figure 27. TPS76801 Adjustable LDO Regulator Programming

POWER-GOOD INDICATOR

The TPS768xx features a power-good (PG) output that can be used to monitor the status of the regulator. The internal comparator monitors the output voltage: when the output drops to between 92% and 98% of its nominal regulated value, the PG output transistor turns on, taking the signal low. The open-drain output requires a pullup resistor. If not used, it can be left floating. PG can be used to drive power-on reset circuitry or used as a low-battery indicator. PG does not assert itself when the regulated output voltage falls out of the specified 2% tolerance, but instead reports an output voltage low, relative to its nominal regulated value.

APPLICATION INFORMATION (continued)

REGULATOR PROTECTION

The TPS768xx PMOS-pass transistor has a built-in back diode that conducts reverse currents when the input voltage drops below the output voltage (e.g., during power down). Current is conducted from the output to the input and is not internally limited. When extended reverse voltage is anticipated, external limiting may be appropriate.

The TPS768xx also features internal current limiting and thermal protection. During normal operation, the TPS768xx limits output current to approximately 1.7 A. When current limiting engages, the output voltage scales back linearly until the overcurrent condition ends. While current limiting is designed to prevent gross device failure, care should be taken not to exceed the power dissipation ratings of the package. If the temperature of the device exceeds 150°C (typ), thermal-protection circuitry shuts it down. Once the device has cooled below 130°C (typ), regulator operation resumes.

POWER DISSIPATION AND JUNCTION TEMPERATURE

Specified regulator operation is assured to a junction temperature of 125°C; the maximum junction temperature should be restricted to 125°C under normal operating conditions. This restriction limits the power dissipation the regulator can handle in any given application. To ensure the junction temperature is within acceptable limits, calculate the maximum allowable dissipation, $P_{D(max)}$, and the actual dissipation, P_D , which must be less than or equal to $P_{D(max)}$.

The maximum-power-dissipation limit is determined using the following equation:

$$P_{D(max)} = \frac{T_{Jmax} - T_A}{R_{\theta JA}}$$

where:

T_{Jmax} is the maximum allowable junction temperature.

$R_{\theta JA}$ is the thermal resistance junction-to-ambient for the package, i.e., 172°C/W for the 8-terminal SOIC and 32.6°C/W for the 20-terminal PWP with no airflow.

T_A is the ambient temperature.

(3)

The regulator dissipation is calculated using:

$$P_D = (V_I - V_O) \times I_O$$

(4)

Power dissipation resulting from quiescent current is negligible. Excessive power dissipation will trigger the thermal protection circuit.

PACKAGING INFORMATION

Orderable Device	Status ⁽¹⁾	Package Type	Package Drawing	Pins	Package Qty	Eco Plan ⁽²⁾	Lead/Ball Finish	MSL Peak Temp ⁽³⁾
TPS76801QD	ACTIVE	SOIC	D	8	75	Green (RoHS & no Sb/Br)	CU NIPDAU	Level-1-260C-UNLIM
TPS76801QDR	ACTIVE	SOIC	D	8	2500	Green (RoHS & no Sb/Br)	CU NIPDAU	Level-1-260C-UNLIM
TPS76801QDRG4	ACTIVE	SOIC	D	8	2500	Green (RoHS & no Sb/Br)	CU NIPDAU	Level-1-260C-UNLIM
TPS76801QPWP	ACTIVE	HTSSOP	PWP	20	70	Green (RoHS & no Sb/Br)	CU NIPDAU	Level-2-260C-1 YEAR
TPS76801QPWPR	ACTIVE	HTSSOP	PWP	20	2000	Green (RoHS & no Sb/Br)	CU NIPDAU	Level-2-260C-1 YEAR
TPS76801QPWPRG4	ACTIVE	HTSSOP	PWP	20	2000	Green (RoHS & no Sb/Br)	CU NIPDAU	Level-2-260C-1 YEAR
TPS76815QD	ACTIVE	SOIC	D	8	75	Green (RoHS & no Sb/Br)	CU NIPDAU	Level-1-260C-UNLIM
TPS76815QDR	ACTIVE	SOIC	D	8	2500	Green (RoHS & no Sb/Br)	CU NIPDAU	Level-1-260C-UNLIM
TPS76815QDRG4	ACTIVE	SOIC	D	8	2500	Green (RoHS & no Sb/Br)	CU NIPDAU	Level-1-260C-UNLIM
TPS76815QPWP	ACTIVE	HTSSOP	PWP	20	70	Green (RoHS & no Sb/Br)	CU NIPDAU	Level-2-260C-1 YEAR
TPS76815QPWPR	ACTIVE	HTSSOP	PWP	20	2000	Green (RoHS & no Sb/Br)	CU NIPDAU	Level-2-260C-1 YEAR
TPS76815QPWPRG4	ACTIVE	HTSSOP	PWP	20	2000	Green (RoHS & no Sb/Br)	CU NIPDAU	Level-2-260C-1 YEAR
TPS76818QD	ACTIVE	SOIC	D	8	75	Green (RoHS & no Sb/Br)	CU NIPDAU	Level-1-260C-UNLIM
TPS76818QDR	ACTIVE	SOIC	D	8	2500	Green (RoHS & no Sb/Br)	CU NIPDAU	Level-1-260C-UNLIM
TPS76818QDRG4	ACTIVE	SOIC	D	8	2500	Green (RoHS & no Sb/Br)	CU NIPDAU	Level-1-260C-UNLIM
TPS76818QPWP	ACTIVE	HTSSOP	PWP	20	70	Green (RoHS & no Sb/Br)	CU NIPDAU	Level-2-260C-1 YEAR
TPS76818QPWPR	ACTIVE	HTSSOP	PWP	20	2000	Green (RoHS & no Sb/Br)	CU NIPDAU	Level-2-260C-1 YEAR
TPS76818QPWPRG4	ACTIVE	HTSSOP	PWP	20	2000	Green (RoHS & no Sb/Br)	CU NIPDAU	Level-2-260C-1 YEAR
TPS76825QD	ACTIVE	SOIC	D	8	75	Green (RoHS & no Sb/Br)	CU NIPDAU	Level-1-260C-UNLIM
TPS76825QDR	ACTIVE	SOIC	D	8	2500	Green (RoHS & no Sb/Br)	CU NIPDAU	Level-1-260C-UNLIM
TPS76825QPWP	ACTIVE	HTSSOP	PWP	20	70	Green (RoHS & no Sb/Br)	CU NIPDAU	Level-2-260C-1 YEAR
TPS76825QPWPR	ACTIVE	HTSSOP	PWP	20	2000	Green (RoHS & no Sb/Br)	CU NIPDAU	Level-2-260C-1 YEAR
TPS76825QPWPRG4	ACTIVE	HTSSOP	PWP	20	2000	Green (RoHS & no Sb/Br)	CU NIPDAU	Level-2-260C-1 YEAR
TPS76827QD	ACTIVE	SOIC	D	8	75	Green (RoHS & no Sb/Br)	CU NIPDAU	Level-1-260C-UNLIM
TPS76827QDG4	ACTIVE	SOIC	D	8	75	Green (RoHS & no Sb/Br)	CU NIPDAU	Level-1-260C-UNLIM

Orderable Device	Status ⁽¹⁾	Package Type	Package Drawing	Pins	Package Qty	Eco Plan ⁽²⁾	Lead/Ball Finish	MSL Peak Temp ⁽³⁾
TPS76827QDR	ACTIVE	SOIC	D	8	2500	Green (RoHS & no Sb/Br)	CU NIPDAU	Level-1-260C-UNLIM
TPS76827QDRG4	ACTIVE	SOIC	D	8	2500	Green (RoHS & no Sb/Br)	CU NIPDAU	Level-1-260C-UNLIM
TPS76827QPWP	ACTIVE	HTSSOP	PWP	20	70	Green (RoHS & no Sb/Br)	CU NIPDAU	Level-2-260C-1 YEAR
TPS76827QPWPG4	ACTIVE	HTSSOP	PWP	20	70	Green (RoHS & no Sb/Br)	CU NIPDAU	Level-2-260C-1 YEAR
TPS76827QPWPR	ACTIVE	HTSSOP	PWP	20	2000	Green (RoHS & no Sb/Br)	CU NIPDAU	Level-2-260C-1 YEAR
TPS76827QPWPRG4	ACTIVE	HTSSOP	PWP	20	2000	Green (RoHS & no Sb/Br)	CU NIPDAU	Level-2-260C-1 YEAR
TPS76828QD	ACTIVE	SOIC	D	8	75	Green (RoHS & no Sb/Br)	CU NIPDAU	Level-1-260C-UNLIM
TPS76828QDG4	ACTIVE	SOIC	D	8	75	Green (RoHS & no Sb/Br)	CU NIPDAU	Level-1-260C-UNLIM
TPS76828QDR	ACTIVE	SOIC	D	8	2500	Green (RoHS & no Sb/Br)	CU NIPDAU	Level-1-260C-UNLIM
TPS76828QDRG4	ACTIVE	SOIC	D	8	2500	Green (RoHS & no Sb/Br)	CU NIPDAU	Level-1-260C-UNLIM
TPS76828QPWP	ACTIVE	HTSSOP	PWP	20	70	Green (RoHS & no Sb/Br)	CU NIPDAU	Level-2-260C-1 YEAR
TPS76828QPWPG4	ACTIVE	HTSSOP	PWP	20	70	Green (RoHS & no Sb/Br)	CU NIPDAU	Level-2-260C-1 YEAR
TPS76828QPWPR	ACTIVE	HTSSOP	PWP	20	2000	Green (RoHS & no Sb/Br)	CU NIPDAU	Level-2-260C-1 YEAR
TPS76828QPWPRG4	ACTIVE	HTSSOP	PWP	20	2000	Green (RoHS & no Sb/Br)	CU NIPDAU	Level-2-260C-1 YEAR
TPS76830QD	ACTIVE	SOIC	D	8	75	Green (RoHS & no Sb/Br)	CU NIPDAU	Level-1-260C-UNLIM
TPS76830QDR	ACTIVE	SOIC	D	8	2500	Green (RoHS & no Sb/Br)	CU NIPDAU	Level-1-260C-UNLIM
TPS76830QDRG4	ACTIVE	SOIC	D	8	2500	Green (RoHS & no Sb/Br)	CU NIPDAU	Level-1-260C-UNLIM
TPS76830QPWP	ACTIVE	HTSSOP	PWP	20	70	Green (RoHS & no Sb/Br)	CU NIPDAU	Level-2-260C-1 YEAR
TPS76830QPWPG4	ACTIVE	HTSSOP	PWP	20	70	Green (RoHS & no Sb/Br)	CU NIPDAU	Level-2-260C-1 YEAR
TPS76830QPWPR	ACTIVE	HTSSOP	PWP	20	2000	Green (RoHS & no Sb/Br)	CU NIPDAU	Level-2-260C-1 YEAR
TPS76830QPWPRG4	ACTIVE	HTSSOP	PWP	20	2000	Green (RoHS & no Sb/Br)	CU NIPDAU	Level-2-260C-1 YEAR
TPS76833QD	ACTIVE	SOIC	D	8	75	Green (RoHS & no Sb/Br)	CU NIPDAU	Level-1-260C-UNLIM
TPS76833QDG4	ACTIVE	SOIC	D	8	75	Green (RoHS & no Sb/Br)	CU NIPDAU	Level-1-260C-UNLIM
TPS76833QDR	ACTIVE	SOIC	D	8	2500	Green (RoHS & no Sb/Br)	CU NIPDAU	Level-1-260C-UNLIM
TPS76833QDRG4	ACTIVE	SOIC	D	8	2500	Green (RoHS & no Sb/Br)	CU NIPDAU	Level-1-260C-UNLIM
TPS76833QPWP	ACTIVE	HTSSOP	PWP	20	70	Green (RoHS & no Sb/Br)	CU NIPDAU	Level-2-260C-1 YEAR

Orderable Device	Status ⁽¹⁾	Package Type	Package Drawing	Pins	Package Qty	Eco Plan ⁽²⁾	Lead/Ball Finish	MSL Peak Temp ⁽³⁾
TPS76833QPWPR	ACTIVE	HTSSOP	PWP	20	2000	Green (RoHS & no Sb/Br)	CU NIPDAU	Level-2-260C-1 YEAR
TPS76833QPWPRG4	ACTIVE	HTSSOP	PWP	20	2000	Green (RoHS & no Sb/Br)	CU NIPDAU	Level-2-260C-1 YEAR
TPS76850QD	ACTIVE	SOIC	D	8	75	Green (RoHS & no Sb/Br)	CU NIPDAU	Level-1-260C-UNLIM
TPS76850QDR	ACTIVE	SOIC	D	8	2500	Green (RoHS & no Sb/Br)	CU NIPDAU	Level-1-260C-UNLIM
TPS76850QDRG4	ACTIVE	SOIC	D	8	2500	Green (RoHS & no Sb/Br)	CU NIPDAU	Level-1-260C-UNLIM
TPS76850QPWP	ACTIVE	HTSSOP	PWP	20	70	Green (RoHS & no Sb/Br)	CU NIPDAU	Level-2-260C-1 YEAR
TPS76850QPWPR	ACTIVE	HTSSOP	PWP	20	2000	Green (RoHS & no Sb/Br)	CU NIPDAU	Level-2-260C-1 YEAR
TPS76850QPWPRG4	ACTIVE	HTSSOP	PWP	20	2000	Green (RoHS & no Sb/Br)	CU NIPDAU	Level-2-260C-1 YEAR

⁽¹⁾ The marketing status values are defined as follows:

ACTIVE: Product device recommended for new designs.

LIFEBUY: TI has announced that the device will be discontinued, and a lifetime-buy period is in effect.

NRND: Not recommended for new designs. Device is in production to support existing customers, but TI does not recommend using this part in a new design.

PREVIEW: Device has been announced but is not in production. Samples may or may not be available.

OBSELETE: TI has discontinued the production of the device.

⁽²⁾ Eco Plan - The planned eco-friendly classification: Pb-Free (RoHS) or Green (RoHS & no Sb/Br) - please check <http://www.ti.com/productcontent> for the latest availability information and additional product content details.

TBD: The Pb-Free/Green conversion plan has not been defined.

Pb-Free (RoHS): TI's terms "Lead-Free" or "Pb-Free" mean semiconductor products that are compatible with the current RoHS requirements for all 6 substances, including the requirement that lead not exceed 0.1% by weight in homogeneous materials. Where designed to be soldered at high temperatures, TI Pb-Free products are suitable for use in specified lead-free processes.

Green (RoHS & no Sb/Br): TI defines "Green" to mean Pb-Free (RoHS compatible), and free of Bromine (Br) and Antimony (Sb) based flame retardants (Br or Sb do not exceed 0.1% by weight in homogeneous material)

⁽³⁾ MSL, Peak Temp. -- The Moisture Sensitivity Level rating according to the JEDEC industry standard classifications, and peak solder temperature.

Important Information and Disclaimer:The information provided on this page represents TI's knowledge and belief as of the date that it is provided. TI bases its knowledge and belief on information provided by third parties, and makes no representation or warranty as to the accuracy of such information. Efforts are underway to better integrate information from third parties. TI has taken and continues to take reasonable steps to provide representative and accurate information but may not have conducted destructive testing or chemical analysis on incoming materials and chemicals. TI and TI suppliers consider certain information to be proprietary, and thus CAS numbers and other limited information may not be available for release.

In no event shall TI's liability arising out of such information exceed the total purchase price of the TI part(s) at issue in this document sold by TI to Customer on an annual basis.

MECHANICAL DATA

PWP (R-PDSO-G**) PowerPAD™ PLASTIC SMALL-OUTLINE PACKAGE

20 PIN SHOWN

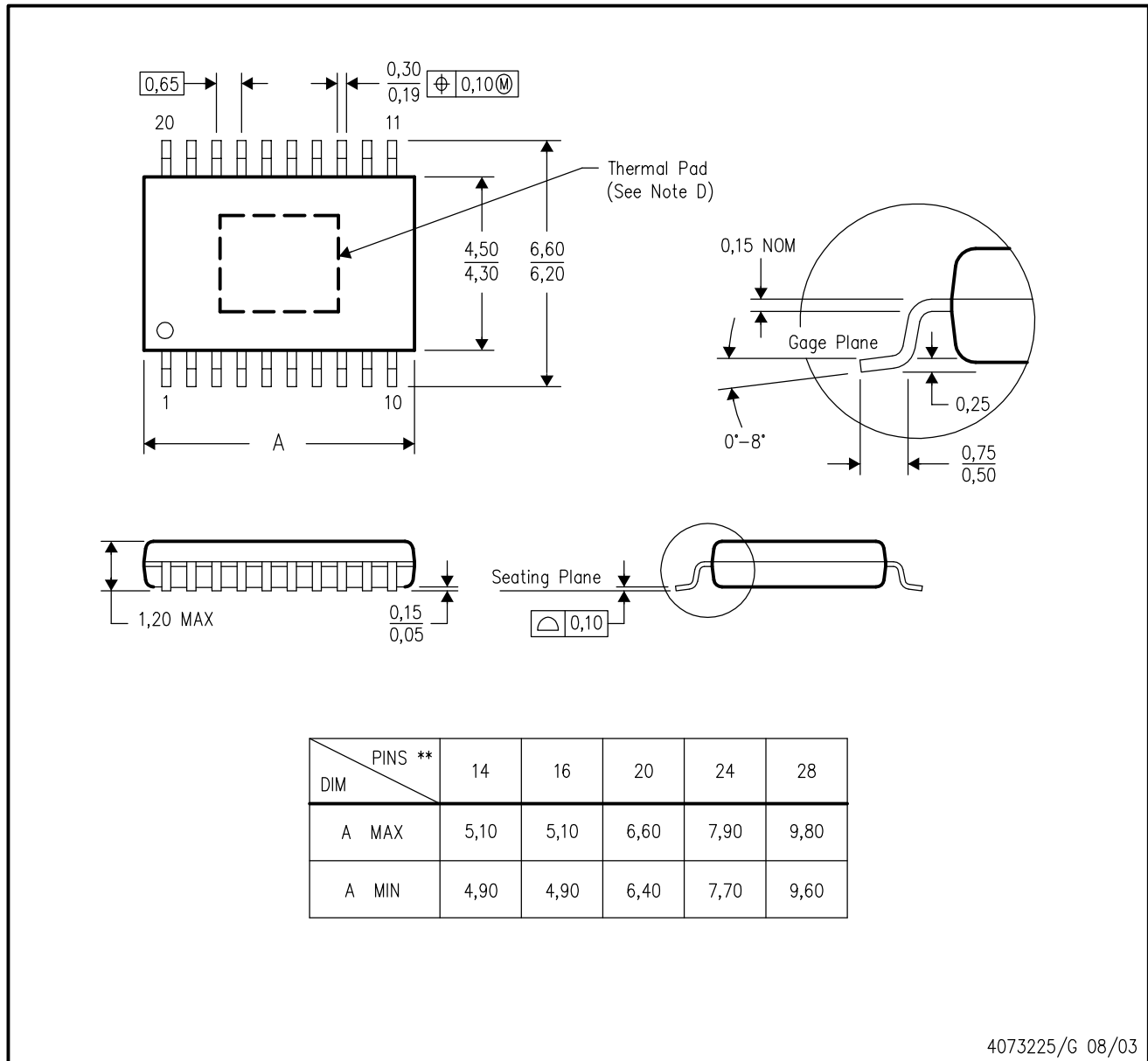

- NOTES:
- All linear dimensions are in millimeters.
 - This drawing is subject to change without notice.
 - Body dimensions do not include mold flash or protrusions.
 - This package is designed to be soldered to a thermal pad on the board. Refer to Technical Brief, PowerPAD Thermally Enhanced Package, Texas Instruments Literature No. SLMA002 for information regarding recommended board layout. This document is available at www.ti.com <<http://www.ti.com>>.
 - Falls within JEDEC MO-153

PowerPAD is a trademark of Texas Instruments.

IMPORTANT NOTICE

Texas Instruments Incorporated and its subsidiaries (TI) reserve the right to make corrections, modifications, enhancements, improvements, and other changes to its products and services at any time and to discontinue any product or service without notice. Customers should obtain the latest relevant information before placing orders and should verify that such information is current and complete. All products are sold subject to TI's terms and conditions of sale supplied at the time of order acknowledgment.

TI warrants performance of its hardware products to the specifications applicable at the time of sale in accordance with TI's standard warranty. Testing and other quality control techniques are used to the extent TI deems necessary to support this warranty. Except where mandated by government requirements, testing of all parameters of each product is not necessarily performed.

TI assumes no liability for applications assistance or customer product design. Customers are responsible for their products and applications using TI components. To minimize the risks associated with customer products and applications, customers should provide adequate design and operating safeguards.

TI does not warrant or represent that any license, either express or implied, is granted under any TI patent right, copyright, mask work right, or other TI intellectual property right relating to any combination, machine, or process in which TI products or services are used. Information published by TI regarding third-party products or services does not constitute a license from TI to use such products or services or a warranty or endorsement thereof. Use of such information may require a license from a third party under the patents or other intellectual property of the third party, or a license from TI under the patents or other intellectual property of TI.

Reproduction of information in TI data books or data sheets is permissible only if reproduction is without alteration and is accompanied by all associated warranties, conditions, limitations, and notices. Reproduction of this information with alteration is an unfair and deceptive business practice. TI is not responsible or liable for such altered documentation.

Resale of TI products or services with statements different from or beyond the parameters stated by TI for that product or service voids all express and any implied warranties for the associated TI product or service and is an unfair and deceptive business practice. TI is not responsible or liable for any such statements.

Following are URLs where you can obtain information on other Texas Instruments products and application solutions:

Products		Applications	
Amplifiers	amplifier.ti.com	Audio	www.ti.com/audio
Data Converters	dataconverter.ti.com	Automotive	www.ti.com/automotive
DSP	dsp.ti.com	Broadband	www.ti.com/broadband
Interface	interface.ti.com	Digital Control	www.ti.com/digitalcontrol
Logic	logic.ti.com	Military	www.ti.com/military
Power Mgmt	power.ti.com	Optical Networking	www.ti.com/opticalnetwork
Microcontrollers	microcontroller.ti.com	Security	www.ti.com/security
		Telephony	www.ti.com/telephony
		Video & Imaging	www.ti.com/video
		Wireless	www.ti.com/wireless

Mailing Address: Texas Instruments
Post Office Box 655303 Dallas, Texas 75265