



February 1986

DS1648/DS3648/DS1678/DS3678 TRI-STATE® TTL to MOS Multiplexers/Drivers

General Description

The DS1648/DS3648 and DS1678/DS3678 are quad 2-input multiplexers with TRI-STATE outputs designed to drive the large capacitive loads (up to 500 pF) associated with MOS memory systems. A PNP input structure is employed to minimize input currents so that driver loading in large memory systems is reduced. The circuit employs Schottky-clamped transistors for high speed and TRI-STATE outputs for bus operation.

The DS1648/DS3648 has a 15Ω resistor in series with the outputs to dampen transients caused by the fast-switching

output. The DS1678/DS3678 has a direct, low impedance output for use with or without an external resistor.

Features

- TRI-STATE outputs interface directly with system-bus
- Schottky-clamped for better ac performance
- PNP inputs to minimize input loading
- TTL compatible
- High-speed capacitive load drivers
- Built-in damping resistor (DS1648/DS3648 only)

Logic and Connection Diagrams

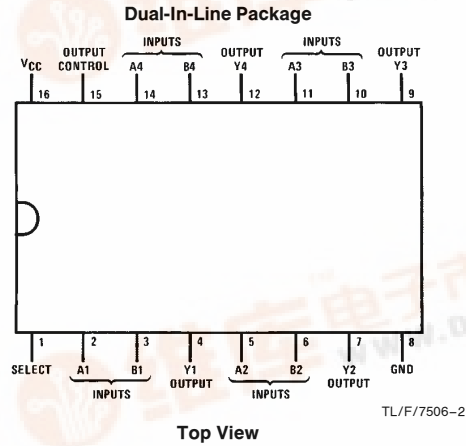
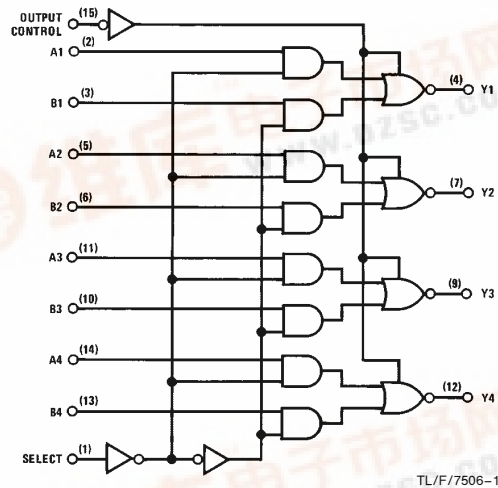

Order Number DS1648J, DS3648J, DS1678J, DS3678J, DS3648N or DS3678N
See NS Package Number J16A or N16A

TRI-STATE® is a registered trademark of National Semiconductor Corp.

DS1648/DS3648/DS1678/DS3678 TRI-STATE TTL to MOS Multiplexers/Drivers



Absolute Maximum Ratings (Note 1)

If Military/Aerospace specified devices are required, please contact the National Semiconductor Sales Office/Distributors for availability and specifications.

Supply Voltage	7V
Logical "1" Input Voltage	7V
Logical "0" Input Voltage	-1.5V
Storage Temperature Range	-65°C to +150°C
Maximum Power Dissipation* at 25°C	
Cavity Package	1433 mW
Molded Package	1362 mW
Lead Temperature (Soldering, 10 seconds)	300°C

* Derate cavity package 9.6 mW/°C above 25°C; derate molded package 10.9 mW/°C above 25°C.

Operating Conditions

	Min	Max	Units
Supply Voltage (V_{CC})	4.5	5.5	V
Temperature (T_A)			
DS1648, DS1678	-55	+125	°C
DS3648, DS3678	0	+70	°C

Electrical Characteristics (Notes 2 and 3)

Symbol	Parameter	Conditions	Min	Typ	Max	Units	
$V_{IN(1)}$	Logical "1" Input Voltage		2.0			V	
$V_{IN(0)}$	Logical "0" Input Voltage				0.8	V	
$I_{IN(1)}$	Logical "1" Input Current	$V_{CC} = 5.5V, V_{IN} = 5.5V$		0.1	40	μA	
$I_{IN(0)}$	Logical "0" Input Current	$V_{CC} = 5.5V, V_{IN} = 0.5V$		-50	-250	μA	
V_{CLAMP}	Input Clamp Voltage	$V_{CC} = 4.5V, I_{IN} = -18 mA$		-0.75	-1.2	V	
V_{OH}	Logical "1" Output Voltage (No Load)	$V_{CC} = 4.5V, I_{OH} = -10 \mu A$	DS1648/DS1678	2.7	3.6		V
			DS3648/DS3678	2.8	3.6		V
V_{OL}	Logical "0" Output Voltage (No Load)	$V_{CC} = 4.5V, I_{OL} = 10 \mu A$	DS1648/DS1678		0.25	0.4	V
			DS3648/DS3678		0.25	0.35	V
V_{OH}	Logical "1" Output Voltage (With Load)	$V_{CC} = 4.5V, I_{OH} = -1.0 mA$	DS1648	2.4	3.5		V
			DS1678	2.5	3.5		V
			DS3648	2.6	3.5		V
			DS3678	2.7	3.5		V
V_{OL}	Logical "0" Output Voltage (With Load)	$V_{CC} = 4.5V, I_{OL} = 20 mA$	DS1648		0.6	1.1	V
			DS1678		0.4	0.5	V
			DS3648		0.6	1.0	V
			DS3678		0.4	0.5	V
I_{1D}	Logical "1" Drive Current	$V_{CC} = 4.5V, V_{OUT} = 0V, (Note 4)$		-250		mA	
I_{0D}	Logical "0" Drive Current	$V_{CC} = 4.5V, V_{OUT} = 4.5V, (Note 4)$		150		mA	
I_{Hi-Z}	TRI-STATE Output Current	$V_{OUT} = 0.4V \text{ to } 2.4V, \text{ Output Control} = 2.0V$	-40		40	μA	
I_{CC}	Power Supply Current	$V_{CC} = 5.5V$	Output Control = 3V All Other Inputs at 0V		42	60	mA
			All Inputs at 0V		20	32	mA

Note 1: "Absolute Maximum Ratings" are those values beyond which the safety of the device cannot be guaranteed. Except for "Operating Temperature Range" they are not meant to imply that the devices should be operated at these limits. The table of "Electrical Characteristics" provides conditions for actual device operation.

Note 2: Unless otherwise specified min/max limits apply across the -55°C to +125°C temperature range for the DS1648 and DS1678 and across the 0°C to +70°C range for the DS3648 and DS3678. All typical values for $T_A = 25^\circ C$ and $V_{CC} = 5V$.

Note 3: All currents into device pins shown as positive, out of device pins as negative, all voltages referenced to ground unless otherwise noted. All values shown as max or min on absolute value basis.

Note 4: When measuring output drive current and switching response for the DS1678 and DS3678 a 15 Ω resistor should be placed in series with each output. This resistor is internal to the DS1648/DS3648 and need not be added.

Switching Characteristics $V_{CC} = 5V, T_A = 25^\circ C$ (Note 4)

Symbol	Parameter	Conditions	Min	Typ	Max	Units
$t_{S\pm}$	Storage Delay Negative Edge	(Figure 1) $C_L = 50\text{ pF}$		5	7	ns
		$C_L = 500\text{ pF}$		9	12	ns
$t_{S\mp}$	Storage Delay Positive Edge	(Figure 1) $C_L = 50\text{ pF}$		6	8	ns
		$C_L = 500\text{ pF}$		9	13	ns
t_F	Fall Time	(Figure 1) $C_L = 50\text{ pF}$		5	8	ns
		$C_L = 500\text{ pF}$		22	35	ns
t_R	Rise Time	(Figure 1) $C_L = 50\text{ pF}$		6	9	ns
		$C_L = 500\text{ pF}$		22	35	ns
t_{ZL}	Delay from Output Control Input to Logical "0" Level (from High Impedance State)	$C_L = 50\text{ pF}, R_L = 2\text{ k}\Omega$ to V_{CC} , (Figure 2)		10	15	ns
t_{ZH}	Delay from Output Control Input to Logical "1" Level (from High Impedance State)	$C_L = 50\text{ pF}, R_L = 2\text{ k}\Omega$ to GND (Figure 2)		8	15	ns
t_{LZ}	Delay from Output Control Input to High Impedance State (from Logical "0" Level)	$C_L = 50\text{ pF}, R_L = 400\Omega$ to V_{CC} , (Figure 3)		15	25	ns
t_{HZ}	Delay from Output Control Input to High Impedance State (from Logical "1" Level)	$C_L = 50\text{ pF}, R_L = 400\Omega$ to GND, (Figure 3)		10	25	ns
$t_{S\pm}$	Propagation Delay to Logical "0" Transition When Select Selects A	$C_L = 50\text{ pF}$, (Figure 1)		12	15	ns
$t_{S\mp}$	Propagation Delay to Logical "1" Transition When Select Selects A	$C_L = 50\text{ pF}$, (Figure 1)		14	17	ns
$t_{S\pm}$	Propagation Delay to Logical "0" Transition When Select Selects B	$C_L = 50\text{ pF}$, (Figure 1)		16	20	ns
$t_{S\mp}$	Propagation Delay to Logical "1" Transition When Select Selects B	$C_L = 50\text{ pF}$, (Figure 1)		14	20	ns

Schematic Diagram

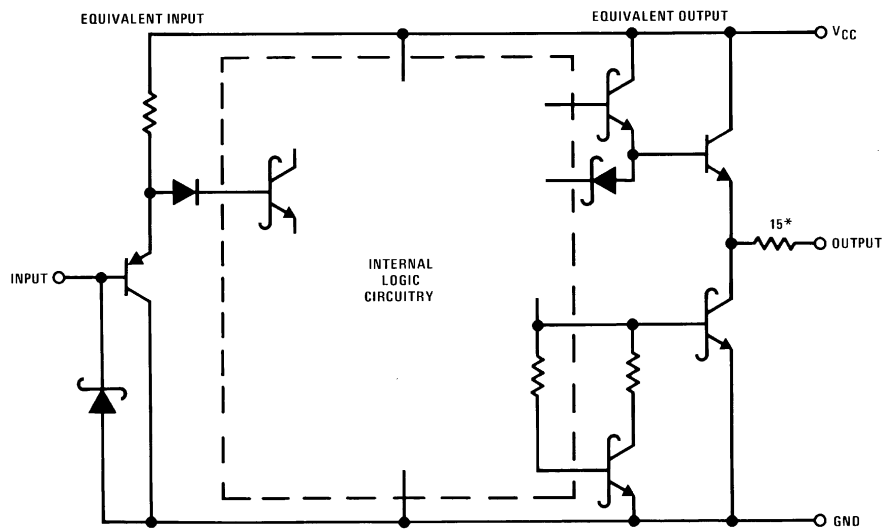

*DS1648/DS3648 only

TL/F/7506-3

AC Test Circuits and Switching Time Waveforms

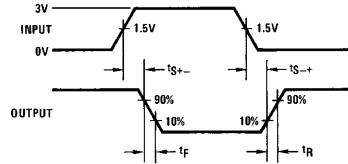
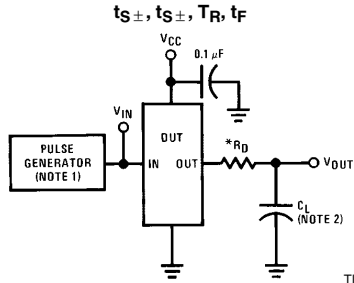

TL/F/7506-5

Note 1: The pulse generator has the following characteristics: $Z_{OUT} = 50\Omega$ and $PRR \leq 1$ MHz. Rise and fall times between 10% and 90% points ≤ 5 ns.

Note 2: C_L includes probe and jig capacitance.

TL/F/7506-4

FIGURE 1

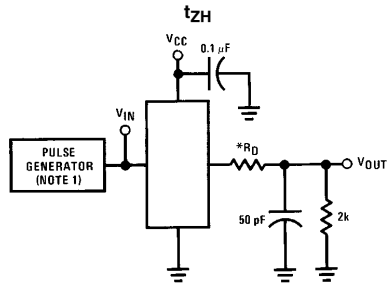

TL/F/7506-6

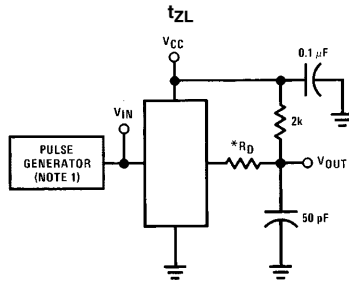

TL/F/7506-7

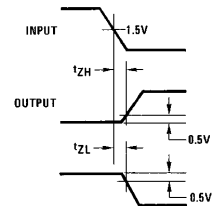

TL/F/7506-8

*Internal on DS1648 and DS3648

FIGURE 2

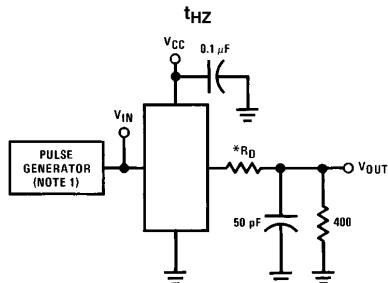

TL/F/7506-9

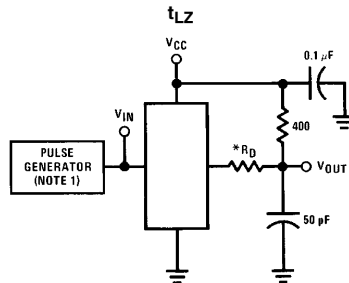

TL/F/7506-10

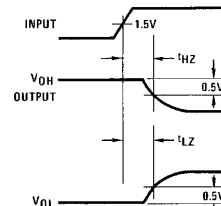

TL/F/7506-11

*Internal on DS1648 and DS3648

FIGURE 3

Truth Table

Output Control	Inputs			Outputs
	Select	A	B	
H	X	X	X	Hi-Z
L	L	L	X	H
L	L	H	X	L
L	H	X	L	H
L	H	X	H	L

H = High level
L = Low level
X = Don't care
Hi-Z = TRI-STATE mode

Typical Applications

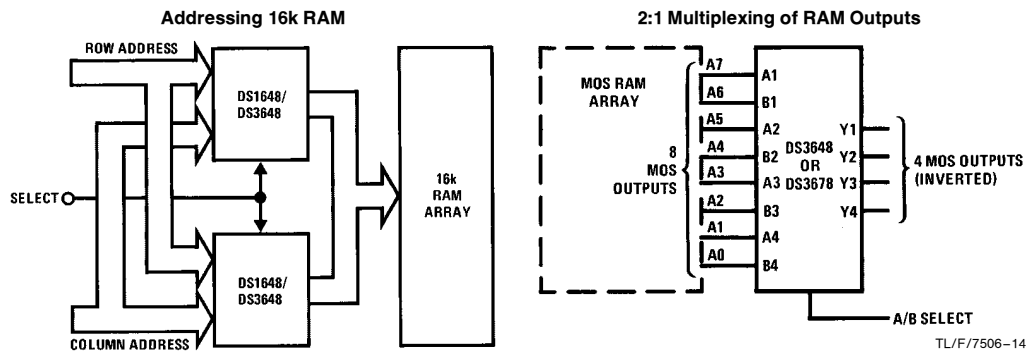

TL/F/7506-12

TL/F/7506-14

Refreshing Using TRI-STATE Counter

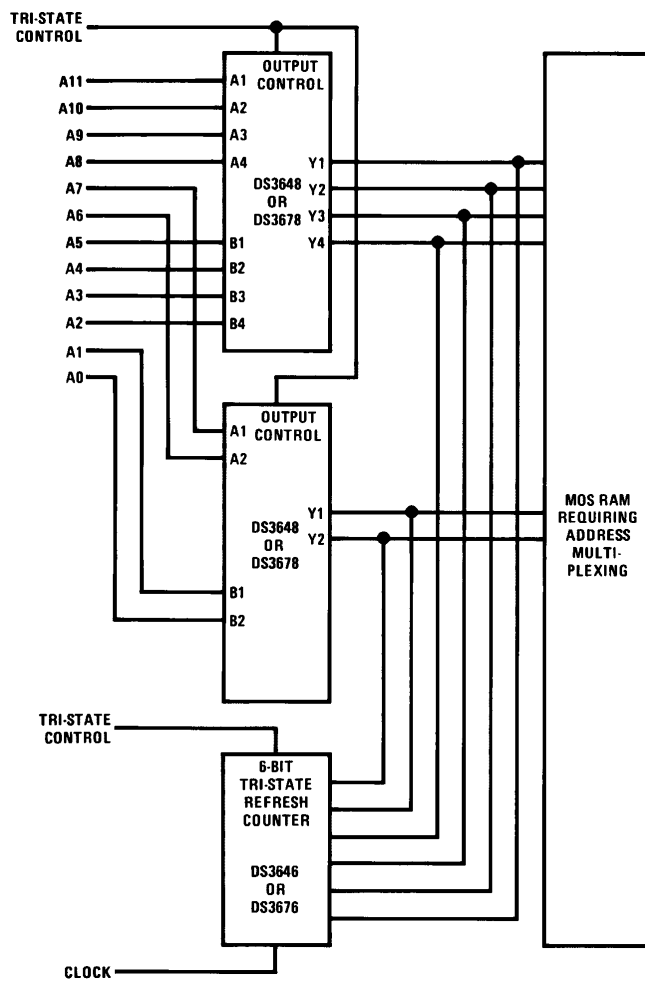

TL/F/7506-13

Physical Dimensions inches (millimeters)

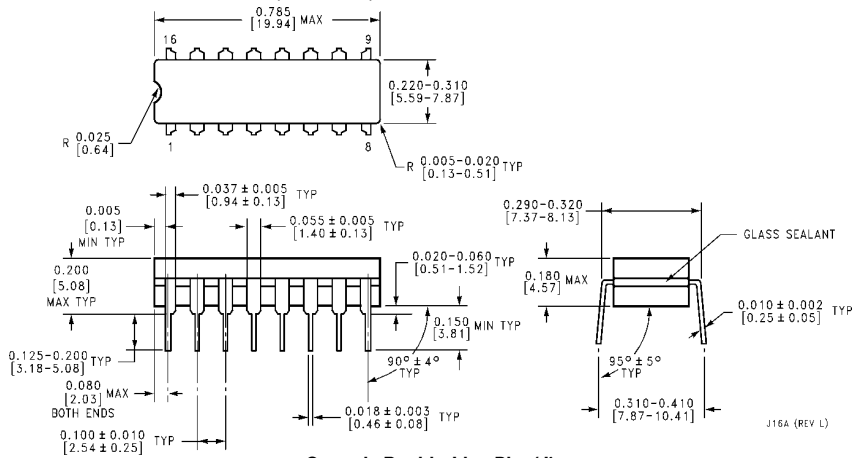

Ceramic Dual-in-Line Pkg (J)
Order Number DS1648J, DS3648J, DS1678J or DS3678J
See NS Package Number J16A

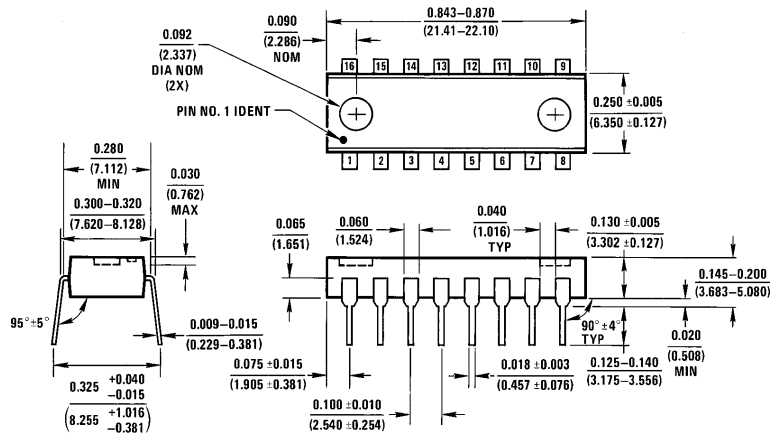

Molded Dual-in-Line Pkg (N)
Order Number DS3648N or DS3678N
See NS Package Number N16A

LIFE SUPPORT POLICY

NATIONAL'S PRODUCTS ARE NOT AUTHORIZED FOR USE AS CRITICAL COMPONENTS IN LIFE SUPPORT DEVICES OR SYSTEMS WITHOUT THE EXPRESS WRITTEN APPROVAL OF THE PRESIDENT OF NATIONAL SEMICONDUCTOR CORPORATION. As used herein:

1. Life support devices or systems are devices or systems which, (a) are intended for surgical implant into the body, or (b) support or sustain life, and whose failure to perform, when properly used in accordance with instructions for use provided in the labeling, can be reasonably expected to result in a significant injury to the user.
2. A critical component is any component of a life support device or system whose failure to perform can be reasonably expected to cause the failure of the life support device or system, or to affect its safety or effectiveness.



National Semiconductor Corporation
 1111 West Bardin Road
 Arlington, TX 76017
 Tel: 1(800) 272-9959
 Fax: 1(800) 737-7018

National Semiconductor Europe
 Fax: (+49) 0-180-530 85 86
 Email: cnjwge@tevm2.nsc.com
 Deutsch Tel: (+49) 0-180-530 85 85
 English Tel: (+49) 0-180-532 78 32
 Français Tel: (+49) 0-180-532 93 58
 Italiano Tel: (+49) 0-180-534 16 80

National Semiconductor Hong Kong Ltd.
 13th Floor, Straight Block,
 Ocean Centre, 5 Canton Rd.
 Tsimshatsui, Kowloon
 Hong Kong
 Tel: (852) 2737-1600
 Fax: (852) 2736-9960

National Semiconductor Japan Ltd.
 Tel: 81-043-299-2309
 Fax: 81-043-299-2408

This datasheet has been download from:

www.datasheetcatalog.com

Datasheets for electronics components.