

April 2000

DS92LV090A

9 Channel Bus LVDS Transceiver

General Description

The DS92LV090A is one in a series of Bus LVDS transceivers designed specifically for the high speed, low power proprietary backplane or cable interfaces. The device operates from a single 3.3V power supply and includes nine differential line drivers and nine receivers. To minimize bus loading, the driver outputs and receiver inputs are internally connected. The separate I/O of the logic side allows for loop back support. The device also features a flow through pin out which allows easy PCB routing for short stubs between its pins and the connector.

The driver translates 3V TTL levels (single-ended) to differential Bus LVDS (BLVDS) output levels. This allows for high speed operation, while consuming minimal power with reduced EMI. In addition, the differential signaling provides common mode noise rejection of $\pm 1V$.

The receiver threshold is less than ± 100 mV over a $\pm 1V$ common mode range and translates the differential Bus LVDS to standard (TTL/CMOS) levels. (See Applications Information Section for more details.)

Features

- Bus LVDS Signaling
- 3.2 nanosecond propagation delay max
- Chip to Chip skew ± 800 ps
- Low power CMOS design
- High Signaling Rate Capability (above 100 Mbps)
- 0.1V to 2.3V Common Mode Range for $V_{ID} = 200$ mV
- ± 100 mV Receiver Sensitivity
- Supports open and terminated failsafe on port pins
- 3.3V operation
- Glitch free power up/down (Driver & Receiver disabled)
- Light Bus Loading (5 pF typical) per Bus LVDS load
- Designed for Double Termination Applications
- Balanced Output Impedance
- Product offered in 64 pin TQFP package
- High impedance Bus pins on power off ($V_{CC} = 0V$)
- Driver Channel to Channel skew (same device) 230ps typical
- Receiver Channel to Channel skew (same device) 370ps typical

Simplified Functional Diagram

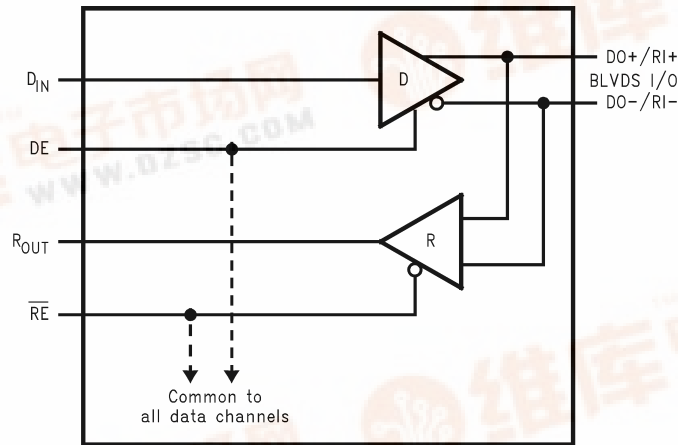

DS100111-1

DS92LV090A9 Channel Bus LVDS Transceiver



Connection Diagram

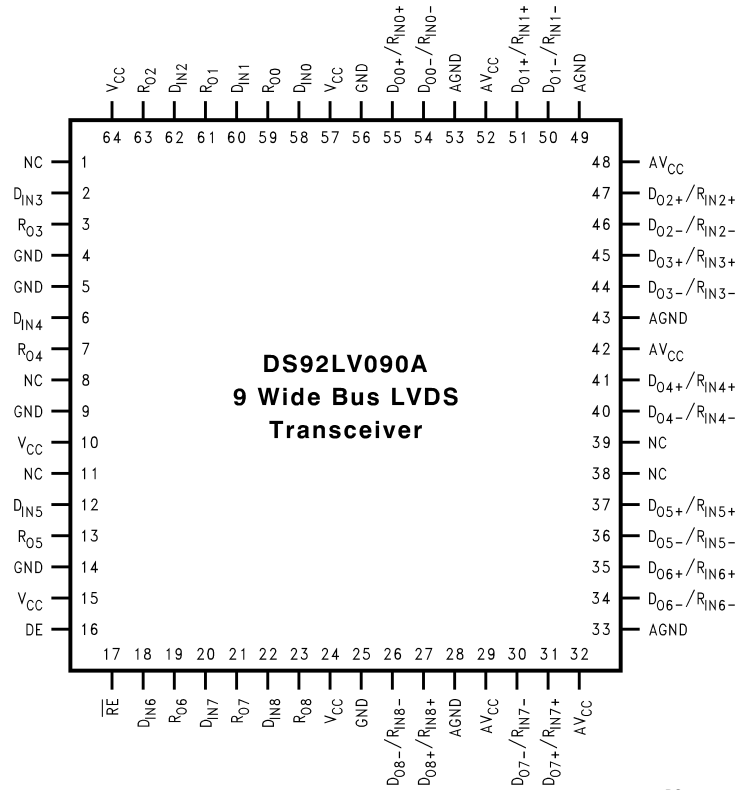

DS100111-2

Top View
Order Number DS92LV090ATVEH
See NS Package Number VEH064DB

Pinout Description

Pin Name	Pin #	Input/Output	Descriptions
DO+/RI+	27, 31, 35, 37, 41, 45, 47, 51, 55	I/O	True Bus LVDS Driver Outputs and Receiver Inputs.
DO-/RI-	26, 30, 34, 36, 40, 44, 46, 50, 54	I/O	Complimentary Bus LVDS Driver Outputs and Receiver Inputs.
D _{IN}	2, 6, 12, 18, 20, 22, 58, 60, 62	I	TTL Driver Input.
R _O	3, 7, 13, 19, 21, 23, 59, 61, 63	O	TTL Receiver Output.
$\overline{\text{RE}}$	17	I	Receiver Enable TTL Input (Active Low).
DE	16	I	Driver Enable TTL Input (Active High).
GND	4, 5, 9, 14, 25, 56	Power	Ground for digital circuitry (must connect to GND on PC board). These pins connected internally.
V _{CC}	10, 15, 24, 57, 64	Power	V _{CC} for digital circuitry (must connect to V _{CC} on PC board). These pins connected internally.
AGND	28, 33, 43, 49, 53	Power	Ground for analog circuitry (must connect to GND on PC board). These pins connected internally.
AV _{CC}	29, 32, 42, 48, 52	Power	Analog V _{CC} (must connect to V _{CC} on PC board). These pins connected internally.
NC	1, 8, 11, 38, 39	N/A	Leave open circuit, do not connect.

Absolute Maximum Ratings (Notes 1, 2)

If Military/Aerospace specified devices are required, please contact the National Semiconductor Sales Office/Distributors for availability and specifications.

Supply Voltage (V_{CC})	4.0V
Enable Input Voltage (\overline{DE} , \overline{RE})	-0.3V to ($V_{CC} + 0.3V$)
Driver Input Voltage (D_{IN})	-0.3V to ($V_{CC} + 0.3V$)
Receiver Output Voltage (R_{OUT})	-0.3V to ($V_{CC} + 0.3V$)
Bus Pin Voltage ($DO/RI\pm$)	-0.3V to +3.9V
ESD (HBM 1.5 k Ω , 100 pF)	>4.5 kV
Driver Short Circuit Duration	momentary
Receiver Short Circuit Duration	momentary
Maximum Package Power Dissipation at 25°C	
TQFP	1.74 W
Derate TQFP Package	13.9 mW/°C

θ_{ja}	71.7°C/W
θ_{jc}	10.9°C/W
Storage Temperature Range	-65°C to +150°C
Lead Temperature (Soldering, 4 sec.)	260°C

Recommended Operating Conditions

	Min	Max	Units
Supply Voltage (V_{CC})	3.0	3.6	V
Receiver Input Voltage	0.0	2.4	V
Operating Free Air Temperature	-40	+85	°C
Maximum Input Edge Rate (Note 6)(20% to 80%)			$\Delta t/\Delta V$
Data		1.0	ns/V
Control		3.0	ns/V

DC Electrical Characteristics

Over recommended operating supply voltage and temperature ranges unless otherwise specified (Notes 2, 3)

Symbol	Parameter	Conditions	Pin	Min	Typ	Max	Units
V_{OD}	Output Differential Voltage	$R_L = 27\Omega$, Figure 1	DO+/RI+, DO-/RI-	240	300	460	mV
ΔV_{OD}	V_{OD} Magnitude Change					27	mV
V_{OS}	Offset Voltage			1.1	1.3	1.5	V
ΔV_{OS}	Offset Magnitude Change				5	10	mV
V_{OH}	Driver Output High Voltage	$R_L = 27\Omega$			1.4	1.65	V
V_{OL}	Driver Output Low Voltage	$R_L = 27\Omega$		0.95	1.1		V
I_{OSD}	Output Short Circuit Current (Note 10)	$V_{OD} = 0V$, $DE = V_{CC}$, Driver outputs shorted together			[36]	[65]	mA
V_{OH}	Voltage Output High (Note 11)	$V_{ID} = +300$ mV	R_{OUT}	$V_{CC}-0.2$			V
		Inputs Open		$V_{CC}-0.2$			V
		Inputs Terminated, $R_L = 27\Omega$		$V_{CC}-0.2$			V
V_{OL}	Voltage Output Low	$I_{OL} = 2.0$ mA, $V_{ID} = -300$ mV			0.05	0.075	V
I_{OD}	Receiver Output Dynamic Current (Note 10)	$V_{ID} = 300$ mV, $V_{OUT} = V_{CC}-1.0V$		-110	[75]		mA
		$V_{ID} = -300$ mV, $V_{OUT} = 1.0V$			[75]	110	mA
V_{TH}	Input Threshold High	$DE = 0V$, $V_{CM} = 1.5V$	DO+/RI+, DO-/RI-			+100	mV
V_{TL}	Input Threshold Low			-100			mV
V_{CMR}	Receiver Common Mode Range			$ V_{ID} /2$		2.4 - $ V_{ID} /2$	V
I_{IN}	Input Current	$DE = 0V$, $\overline{RE} = 2.4V$, $V_{IN} = +2.4V$ or $0V$		-20	± 1	+20	μA
		$V_{CC} = 0V$, $V_{IN} = +2.4V$ or $0V$		-20	± 1	+20	μA

DC Electrical Characteristics (Continued)

Over recommended operating supply voltage and temperature ranges unless otherwise specified (Notes 2, 3)

Symbol	Parameter	Conditions	Pin	Min	Typ	Max	Units
V_{IH}	Minimum Input High Voltage		$D_{IN}, DE, \overline{RE}$	2.0		V_{CC}	V
V_{IL}	Maximum Input Low Voltage			GND		0.8	V
I_{IH}	Input High Current	$V_{IN} = V_{CC}$ or 2.4V		-20	± 10	+20	μA
I_{IL}	Input Low Current	$V_{IN} = GND$ or 0.4V		-20	± 10	+20	μA
V_{CL}	Input Diode Clamp Voltage	$I_{CLAMP} = -18$ mA		-1.5	-0.8		V
I_{CCD}	Power Supply Current Drivers Enabled, Receivers Disabled	No Load, $DE = \overline{RE} = V_{CC}$, $DIN = V_{CC}$ or GND	V_{CC}		55	80	mA
I_{CCR}	Power Supply Current Drivers Disabled, Receivers Enabled	$DE = \overline{RE} = 0V$, $V_{ID} = \pm 300mV$			73	80	mA
I_{CCZ}	Power Supply Current, Drivers and Receivers TRI-STATE®	$DE = 0V$; $\overline{RE} = V_{CC}$, $DIN = V_{CC}$ or GND			35	80	mA
I_{CC}	Power Supply Current, Drivers and Receivers Enabled	$DE = V_{CC}$; $\overline{RE} = 0V$, $DIN = V_{CC}$ or GND, $R_L = 27\Omega$			170	210	mA
I_{OFF}	Power Off Leakage Current	$V_{CC} = 0V$ or OPEN, $D_{IN}, DE, \overline{RE} = 0V$ or OPEN, $V_{APPLIED} = 3.6V$ (Port Pins)	DO+/RI+, DO-/RI-	-20		+20	μA
C_{OUTPUT}	Capacitance @ Bus Pins		DO+/RI+, DO-/RI-		5		pF
C_{OUTPUT}	Capacitance @ R_{OUT}		R_{OUT}		7		pF

AC Electrical Characteristics

Over recommended operating supply voltage and temperature ranges unless otherwise specified (Note 6)

Symbol	Parameter	Conditions	Min	Typ	Max	Units
DIFFERENTIAL DRIVER TIMING REQUIREMENTS						
t_{PHLD}	Differential Prop. Delay High to Low (Note 8)	$R_L = 27\Omega$, Figures 2, 3, $C_L = 10$ pF	0.6	1.4	2.2	ns
t_{PLHD}	Differential Prop. Delay Low to High (Note 8)		0.6	1.4	2.2	ns
t_{SKD1}	Differential Skew $ t_{PHLD} - t_{PLHD} $ (Note 9)			80		ps
t_{SKD2}	Chip to Chip Skew (Note 12)				1.6	ns
t_{SKD3}	Channel to Channel Skew (Note 13)			0.25	0.45	ns
t_{TLH}	Transition Time Low to High			0.6	1.2	ns
t_{THL}	Transition Time High to Low			0.5	1.2	ns
t_{PHZ}	Disable Time High to Z	$R_L = 27\Omega$, Figures 4, 5, $C_L = 10$ pF		3	8	ns
t_{PLZ}	Disable Time Low to Z			3	8	ns
t_{PZH}	Enable Time Z to High			3	8	ns
t_{PZL}	Enable Time Z to Low			3	8	ns
DIFFERENTIAL RECEIVER TIMING REQUIREMENTS						
t_{PHLD}	Differential Prop. Delay High to Low (Note 8)	$Figures 6, 7$, $C_L = 35$ pF	1.6	2.4	3.2	ns
t_{PLHD}	Differential Prop Delay Low to High (Note 8)		1.6	2.4	3.2	ns
t_{SDK1}	Differential Skew $ t_{PHLD} - t_{PLHD} $ (Note 9)			80		ps
t_{SDK2}	Chip to Chip Skew (Note 12)				1.6	ns
t_{SDK3}	Channel to Channel Skew (Note 13)			0.35	0.60	ns
t_{TLH}	Transition Time Low to High			1.5	2.5	ns
t_{THL}	Transition Time High to Low			1.5	2.5	ns

AC Electrical Characteristics (Continued)

Over recommended operating supply voltage and temperature ranges unless otherwise specified (Note 6)

Symbol	Parameter	Conditions	Min	Typ	Max	Units
DIFFERENTIAL RECEIVER TIMING REQUIREMENTS						
t_{PHZ}	Disable Time High to Z	$R_L = 500\Omega$, <i>Figures 8, 9,</i> $C_L = 35\text{ pF}$		4.5	10	ns
t_{PLZ}	Disable Time Low to Z			3.5	8	ns
t_{PZH}	Enable Time Z to High			3.5	8	ns
t_{PZL}	Enable Time Z to Low			3.5	8	ns

Note 1: "Absolute Maximum Ratings" are those values beyond which the safety of the device cannot be guaranteed. They are not meant to imply that the devices should be operated at these limits. The table of "Electrical Characteristics" provides conditions for actual device operation.

Note 2: All currents into device pins are positive; all currents out of device pins are negative. All voltages are referenced to ground unless otherwise specified except V_{OD} , ΔV_{OD} and V_{ID} .

Note 3: All typicals are given for $V_{CC} = +3.3V$ and $T_A = +25^\circ C$, unless otherwise stated.

Note 4: ESD Rating: HBM (1.5 k Ω , 100 pF) > 4.5 kV EIAJ (0 Ω , 200 pF) > 300V.

Note 5: C_L includes probe and fixture capacitance.

Note 6: Generator waveforms for all tests unless otherwise specified: $f = 25\text{ MHz}$, $Z_O = 50\Omega$, t_r , $t_f = <1.0\text{ ns}$ (0%–100%). To ensure fastest propagation delay and minimum skew, data input edge rates should be equal to or faster than 1ns/V; control signals equal to or faster than 3ns/V. In general, the faster the input edge rate, the better the AC performance.

Note 7: The DS92LV090A functions within datasheet specification when a resistive load is applied to the driver outputs.

Note 8: Propagation delays are guaranteed by design and characterization.

Note 9: t_{SKD1} ($t_{PHLD} - t_{PLHD}$) is the worst case skew between any channel and any device over recommended operation conditions.

Note 10: Only one output at a time should be shorted, do not exceed maximum package power dissipation capacity.

Note 11: V_{OH} failsafe terminated test performed with 27 Ω connected between RI+ and RI- inputs. No external voltage is applied.

Note 12: Chip to Chip skew is the difference in differential propagation delay between any channels of any devices, either edge.

Note 13: Channel to Channel skew is the difference in driver output or receiver output propagation delay between any channels within a device, either edge.

Applications Information

General application guidelines and hints may be found in the following application notes: AN-808, AN-1035, AN-977, AN-971, AN-918, and AN-903.

There are a few common practices which should be implied when designing PCB for Bus LVDS signaling. Recommended practices are:

- Use at least 4 PCB board layer (Bus LVDS signals, ground, power and TTL signals).
- Keep drivers and receivers as close to the (Bus LVDS port side) connector as possible.
- Bypass each Bus LVDS device and also use distributed bulk capacitance between power planes. Surface mount capacitors placed close to power and ground pins work best. Two or three high frequency, multi-layer ceramic (MLC) surface mount (0.1 μF , 0.01 μF , 0.001 μF) in parallel should be used between each V_{CC} and ground. The capacitors should be as close as possible to the V_{CC} pin.

Multiple vias should be used to connect V_{CC} and Ground planes to the pads of the by-pass capacitors.

In addition, randomly distributed by-pass capacitors should be used.

- Use the termination resistor which best matches the differential impedance of your transmission line.
- Leave unused Bus LVDS receiver inputs open (floating). Limit traces on unused inputs to <0.5 inches.
- Isolate TTL signals from Bus LVDS signals

MEDIA (CONNECTOR or BACKPLANE) SELECTION:

- Use controlled impedance media. The backplane and connectors should have a matched differential impedance.

TABLE 1. Functional Table

MODE SELECTED	DE	\overline{RE}
DRIVER MODE	H	H
RECEIVER MODE	L	L
TRI-STATE MODE	L	H
LOOP BACK MODE	H	L

TABLE 2. Transmitter Mode

INPUTS		OUTPUTS	
DE	D_{IN}	DO+	DO-
H	L	L	H
H	H	H	L
H	$0.8V < D_{IN} < 2.0V$	X	X
L	X	Z	Z

TABLE 3. Receiver Mode

INPUTS		OUTPUT
\overline{RE}	(RI+) – (RI-)	
L	L (< -100 mV)	L
L	H (> +100 mV)	H
L	$-100\text{ mV} < V_{ID} < +100\text{ mV}$	X
H	X	Z

X = High or Low logic state

L = Low state

Z = High impedance state

H = High state

Test Circuits and Timing Waveforms

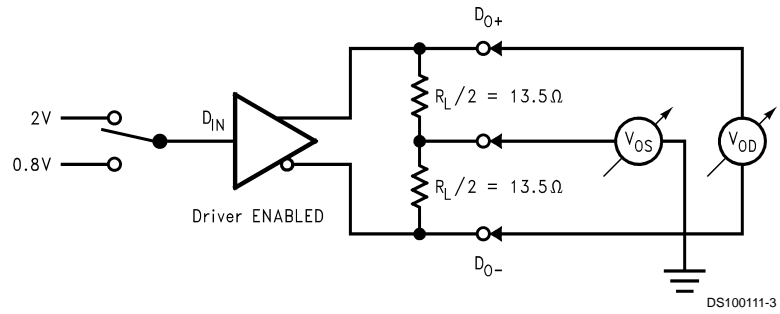

FIGURE 1. Differential Driver DC Test Circuit

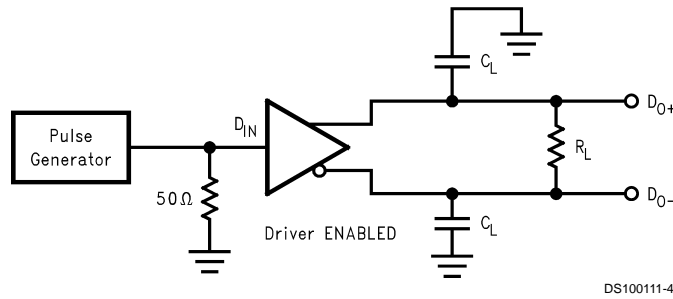

FIGURE 2. Differential Driver Propagation Delay and Transition Time Test Circuit

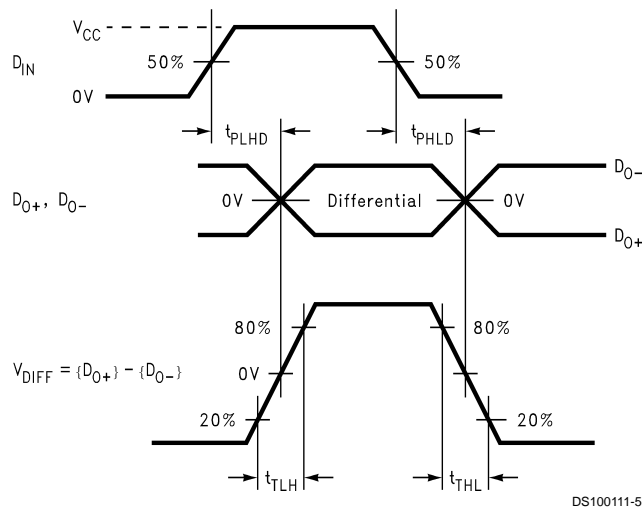
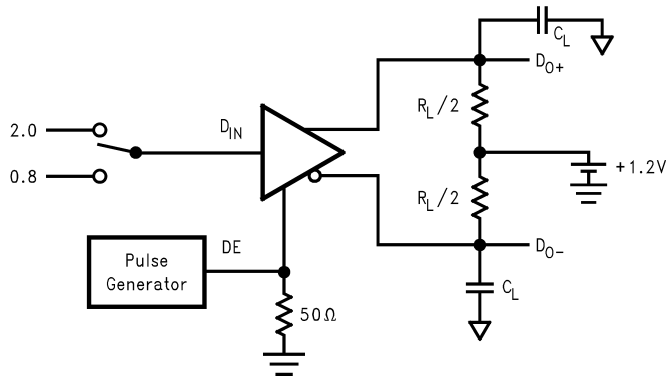

FIGURE 3. Differential Driver Propagation Delay and Transition Time Waveforms

Test Circuits and Timing Waveforms (Continued)



DS100111-6

FIGURE 4. Driver TRI-STATE Delay Test Circuit

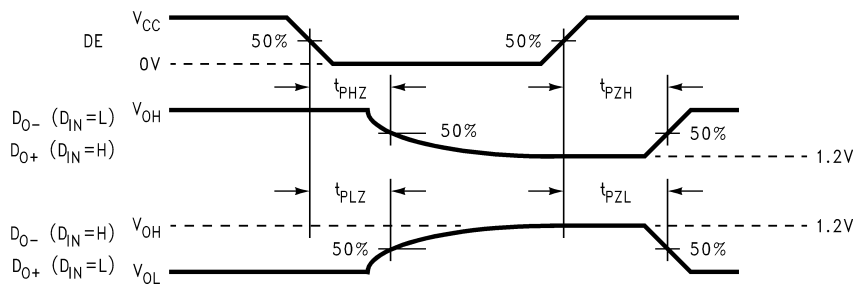

DS100111-7

FIGURE 5. Driver TRI-STATE Delay Waveforms

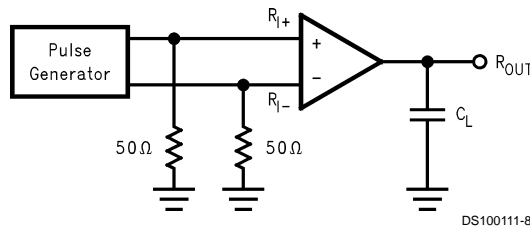

DS100111-8

FIGURE 6. Receiver Propagation Delay and Transition Time Test Circuit

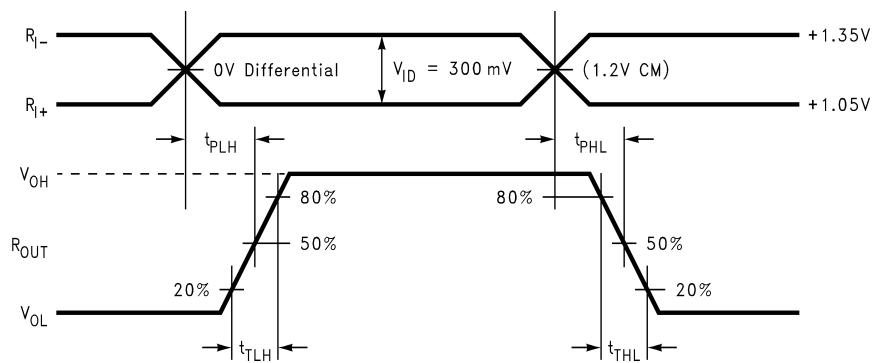

DS100111-9

FIGURE 7. Receiver Propagation Delay and Transition Time Waveforms

Test Circuits and Timing Waveforms (Continued)

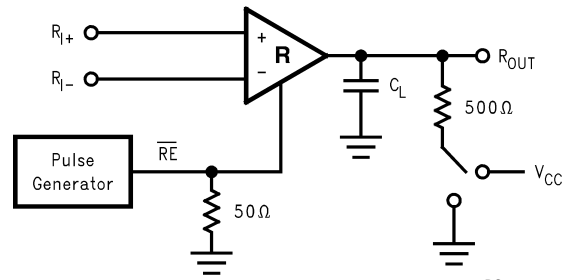

DS100111-10

FIGURE 8. Receiver TRI-STATE Delay Test Circuit

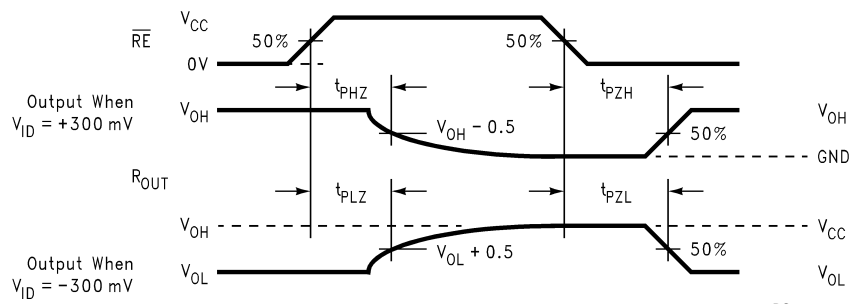

DS100111-11

FIGURE 9. Receiver TRI-STATE Delay Waveforms

Typical Bus Application Configurations

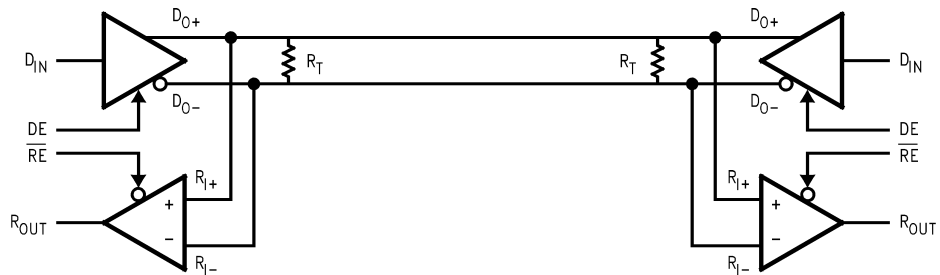

DS100111-12

Bi-Directional Half-Duplex Point-to-Point Applications

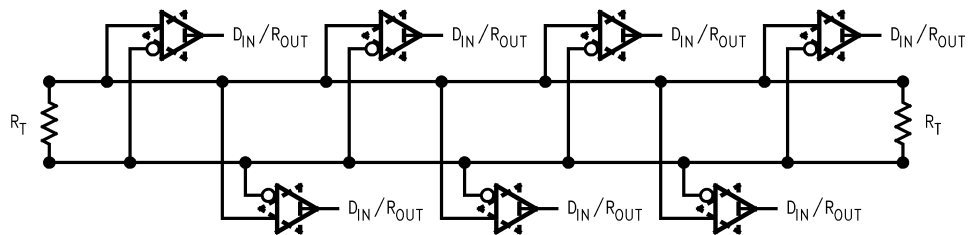

DS100111-13

Multi-Point Bus Applications

Physical Dimensions All dimensions are in millimeters

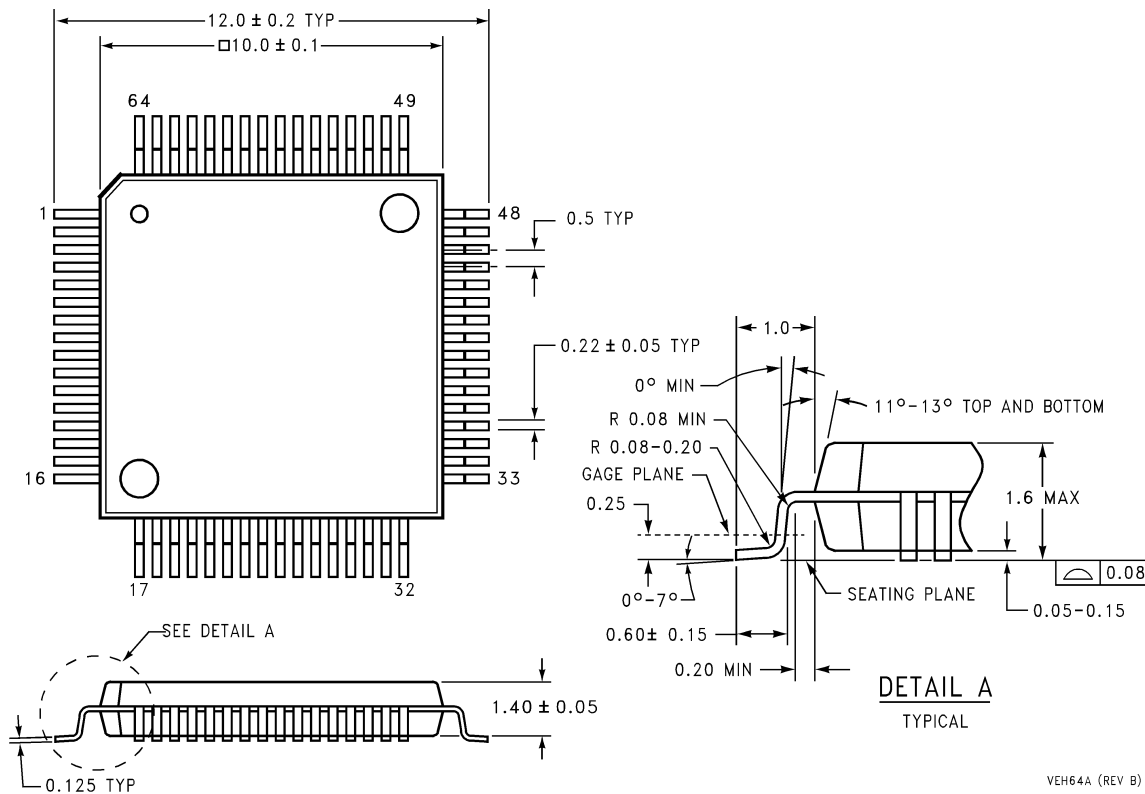

64-Lead Molded TQFP Package
Order Number DS92LV090ATVEH
NS Package Number VEH064DB

LIFE SUPPORT POLICY

NATIONAL'S PRODUCTS ARE NOT AUTHORIZED FOR USE AS CRITICAL COMPONENTS IN LIFE SUPPORT DEVICES OR SYSTEMS WITHOUT THE EXPRESS WRITTEN APPROVAL OF THE PRESIDENT AND GENERAL COUNSEL OF NATIONAL SEMICONDUCTOR CORPORATION. As used herein:

1. Life support devices or systems are devices or systems which, (a) are intended for surgical implant into the body, or (b) support or sustain life, and whose failure to perform when properly used in accordance with instructions for use provided in the labeling, can be reasonably expected to result in a significant injury to the user.
2. A critical component is any component of a life support device or system whose failure to perform can be reasonably expected to cause the failure of the life support device or system, or to affect its safety or effectiveness.

National Semiconductor Corporation
Americas
Tel: 1-800-272-9959
Fax: 1-800-737-7018
Email: support@nsc.com
www.national.com

National Semiconductor Europe
Fax: +49 (0) 180-530 85 86
Email: europe.support@nsc.com
Deutsch Tel: +49 (0) 69 9508 6208
English Tel: +44 (0) 870 24 0 2171
Français Tel: +33 (0) 1 41 91 8790

National Semiconductor Asia Pacific Customer Response Group
Tel: 65-2544466
Fax: 65-2504466
Email: ap.support@nsc.com

National Semiconductor Japan Ltd.
Tel: 81-3-5639-7560
Fax: 81-3-5639-7507