



# Low-Noise, Low-Dropout, 150mA Linear Regulators with '2982 Pinout

## General Description

The MAX8877/MAX8878 low-noise, low-dropout linear regulators operate from a 2.5V to 6.5V input and deliver up to 150mA. These devices are pin-compatible with the industry-standard '2982 and offer an improved dropout voltage. Typical output noise is 30 $\mu$ V<sub>RMS</sub>, and typical dropout is only 165mV at 150mA. The output voltage is preset to voltages in the range of 2.5V to 5.0V, in 100mV increments.

Designed with an internal P-channel MOSFET pass transistor, the MAX8877/MAX8878 maintain a low 100 $\mu$ A supply current, independent of the load current and dropout voltage. Other features include a 10nA logic-controlled shutdown mode, short-circuit and thermal-shutdown protection, and reverse battery protection. The MAX8878 also includes an auto-discharge function, which actively discharges the output voltage to ground when the device is placed in shutdown. Both devices come in a miniature 5-pin SOT23 package.

## Applications

- Cellular Telephones
- Cordless Telephones
- PCS Telephones
- PCMCIA Cards
- Modems
- Hand-Held Instruments
- Palmtop Computers
- Electronic Planners

## Typical Operating Circuit

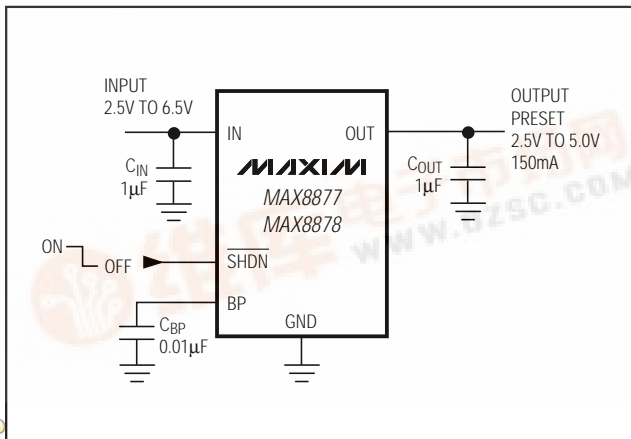

## Features

- ◆ Pin-Compatible with the Industry-Standard '2982
- ◆ Low Output Noise: 30 $\mu$ V<sub>RMS</sub>
- ◆ Low 55mV Dropout at 50mA Output (165mV at 150mA output)
- ◆ Low 85 $\mu$ A No-Load Supply Current
- ◆ Low 100 $\mu$ A Operating Supply Current (even in dropout)
- ◆ Thermal-Overload and Short-Circuit Protection
- ◆ Reverse Battery Protection
- ◆ Output Current Limit
- ◆ Preset Output Voltages ( $\pm$ 1.4% Accuracy)
- ◆ 10nA Logic-Controlled Shutdown

## Ordering Information

PART**	TEMP. RANGE	PIN-PACKAGE
MAX8877C/Dxy	0°C to +70°C	Dice*
MAX8877EUKxy-T	-40°C to +85°C	5 SOT23-5
MAX8878C/Dxy	0°C to +70°C	Dice*
MAX8878EUKxy-T	-40°C to +85°C	5 SOT23-5

\*Dice are tested at  $T_A = +25^\circ\text{C}$  only.

\*\*xy is the output voltage code (see Expanded Ordering Information table at end of data sheet).

## Pin Configuration

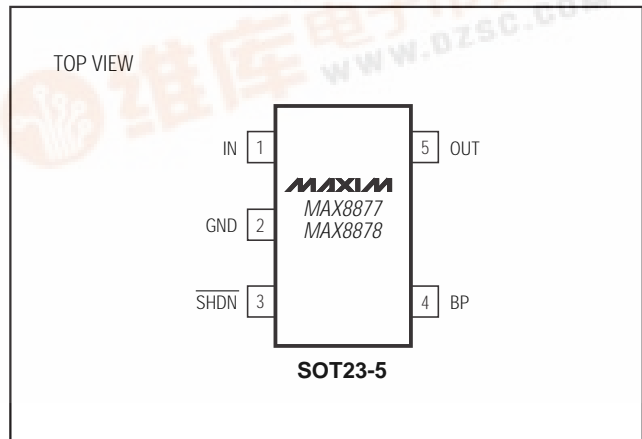

MAX8877/MAX8878

# Low-Noise, Low-Dropout, 150mA Linear Regulators with '2982 Pinout

## ABSOLUTE MAXIMUM RATINGS

IN to GND .....	-7V to +7V	Operating Temperature Range .....	-40°C to +85°C
Output Short-Circuit Duration .....	Infinite	Junction Temperature .....	+150°C
$\overline{\text{SHDN}}$ to GND .....	-7V to +7V	$\theta_{\text{JB}}$ .....	140°C/W
$\overline{\text{SHDN}}$ to IN .....	-7V to +0.3V	Storage Temperature .....	-65°C to +160°C
OUT, BP to GND .....	-0.3V to ( $V_{\text{IN}} + 0.3\text{V}$ )	Lead Temperature (soldering, 10sec) .....	+300°C
Continuous Power Dissipation ( $T_{\text{A}} = +70^{\circ}\text{C}$ )			
SOT23-5 (derate 7.1mW/°C above +70°C) .....	571mW		

Stresses beyond those listed under "Absolute Maximum Ratings" may cause permanent damage to the device. These are stress ratings only, and functional operation of the device at these or any other conditions beyond those indicated in the operational sections of the specifications is not implied. Exposure to absolute maximum rating conditions for extended periods may affect device reliability.

## ELECTRICAL CHARACTERISTICS

( $V_{\text{IN}} = V_{\text{OUT(NOMINAL)}} + 0.5\text{V}$ ,  $T_{\text{A}} = -40^{\circ}\text{C}$  to  $+85^{\circ}\text{C}$ , unless otherwise noted. Typical values are at  $T_{\text{A}} = +25^{\circ}\text{C}$ .) (Note 1)

PARAMETER	SYMBOL	CONDITIONS	MIN	TYP	MAX	UNITS
Input Voltage	$V_{\text{IN}}$		2.5		6.5	V
Output Voltage Accuracy		$I_{\text{OUT}} = 0\text{mA}$ , $T_{\text{A}} = +25^{\circ}\text{C}$	-1.4		1.4	%
		$I_{\text{OUT}} = 0\text{mA}$ to $120\text{mA}$ , $T_{\text{A}} = -40^{\circ}\text{C}$ to $+85^{\circ}\text{C}$	-3		2	
Maximum Output Current			150			mA
Current Limit	$I_{\text{LIM}}$		160	390		mA
Ground Pin Current	$I_{\text{O}}$	No load		85	180	$\mu\text{A}$
		$I_{\text{OUT}} = 150\text{mA}$		100		
Dropout Voltage (Note 2)		$I_{\text{OUT}} = 1\text{mA}$		1.1		mV
		$I_{\text{OUT}} = 50\text{mA}$		55	120	
		$I_{\text{OUT}} = 150\text{mA}$		165		
Line Regulation	$\Delta V_{\text{LNR}}$	$V_{\text{IN}} = (V_{\text{OUT}} + 0.1\text{V})$ to $6.5\text{V}$ , $I_{\text{OUT}} = 1\text{mA}$	-0.15	0	0.15	%/V
Load Regulation	$\Delta V_{\text{LDR}}$	$I_{\text{OUT}} = 0\text{mA}$ to $120\text{mA}$ , $C_{\text{OUT}} = 1\mu\text{F}$		0.01	0.04	%/mA
Output Voltage Noise	$e_{\text{n}}$	$f = 10\text{Hz}$ to $100\text{kHz}$ , $C_{\text{BP}} = 0.01\mu\text{F}$	$C_{\text{OUT}} = 10\mu\text{F}$		30	$\mu\text{VRMS}$
			$C_{\text{OUT}} = 100\mu\text{F}$		20	
<b>SHUTDOWN</b>						
$\overline{\text{SHDN}}$ Input Threshold	$V_{\text{IH}}$	$V_{\text{IN}} = 2.5\text{V}$ to $5.5\text{V}$	2.0			V
	$V_{\text{IL}}$	$V_{\text{IN}} = 2.5\text{V}$ to $5.5\text{V}$			0.4	
$\overline{\text{SHDN}}$ Input Bias Current	$I_{\text{SHDN}}$	$V_{\text{SHDN}} = V_{\text{IN}}$	$T_{\text{A}} = +25^{\circ}\text{C}$	0.01	100	nA
			$T_{\text{A}} = +85^{\circ}\text{C}$	0.5		
Shutdown Supply Current	$I_{\text{O(SHDN)}}$	$V_{\text{OUT}} = 0\text{V}$	$T_{\text{A}} = +25^{\circ}\text{C}$	0.01	1	$\mu\text{A}$
			$T_{\text{A}} = +85^{\circ}\text{C}$	0.2		
Shutdown Exit Delay (Note 3)		$C_{\text{BP}} = 0.1\mu\text{F}$ , $C_{\text{OUT}} = 1\mu\text{F}$ , no load	$T_{\text{A}} = +25^{\circ}\text{C}$	30	150	$\mu\text{s}$
			$T_{\text{A}} = -40^{\circ}\text{C}$ to $+85^{\circ}\text{C}$	300		
Resistance Shutdown Discharge		MAX8878 only		300		$\Omega$
<b>THERMAL PROTECTION</b>						
Thermal Shutdown Temperature	$T_{\text{SHDN}}$			155		$^{\circ}\text{C}$
Thermal Shutdown Hysteresis	$\Delta T_{\text{SHDN}}$			15		$^{\circ}\text{C}$

**Note 1:** Limits are 100% production tested at  $T_{\text{A}} = +25^{\circ}\text{C}$ . Limits over the operating temperature range are guaranteed through correlation using Statistical Quality Control (SQC) Methods.

**Note 2:** The dropout voltage is defined as  $V_{\text{IN}} - V_{\text{OUT}}$ , when  $V_{\text{OUT}}$  is 100mV below the value of  $V_{\text{OUT}}$  for  $V_{\text{IN}} = V_{\text{OUT}} + 0.5\text{V}$ .

**Note 3:** Time needed for  $V_{\text{OUT}}$  to reach 95% of final value.

# Low-Noise, Low-Dropout, 150mA Linear Regulators with '2982 Pinout

## Typical Operating Characteristics

( $V_{IN} = V_{OUT(NOMINAL)} + 0.5V$ ,  $C_{IN} = 1\mu F$ ,  $C_{OUT} = 1\mu F$ ,  $C_{BP} = 0.01\mu F$ ,  $T_A = +25^\circ C$ , unless otherwise noted.)

MAX8877/MAX8878

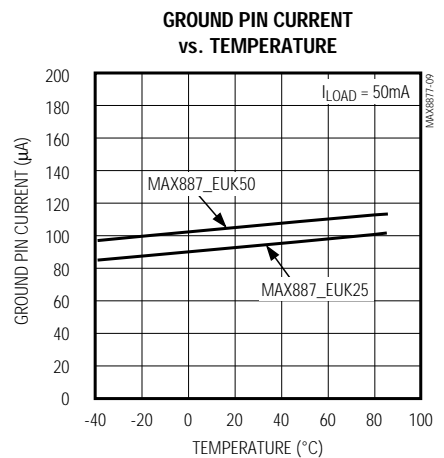
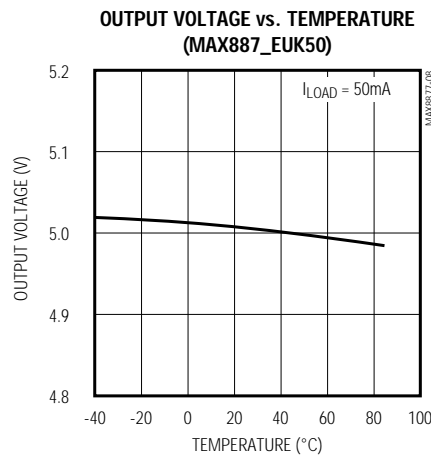
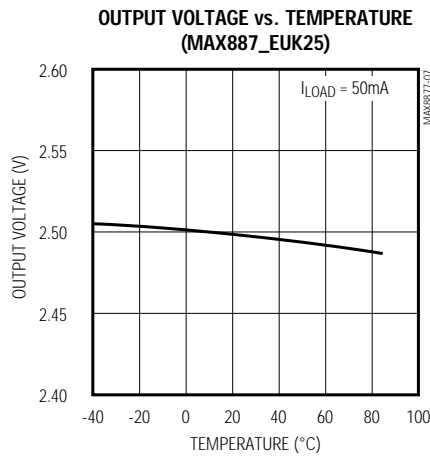
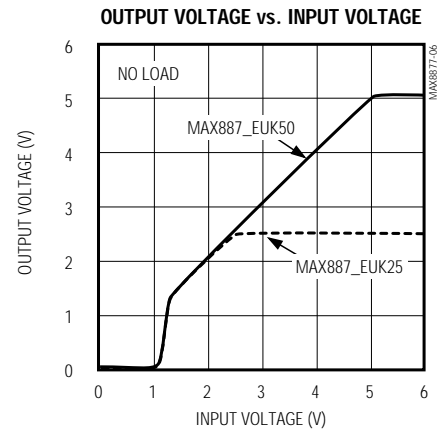
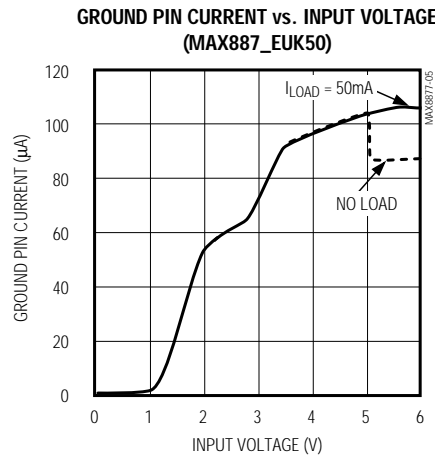
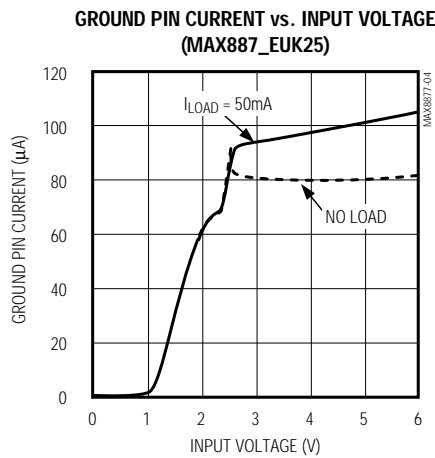
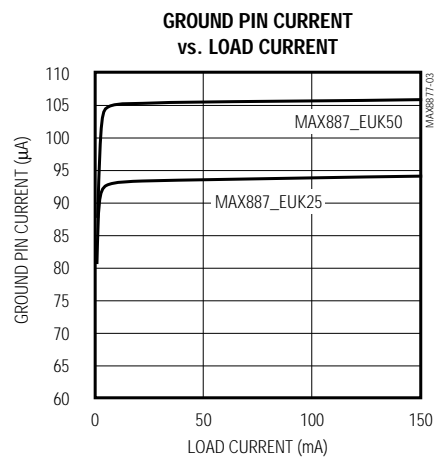
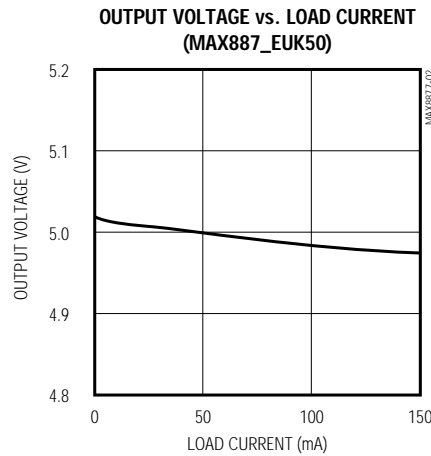
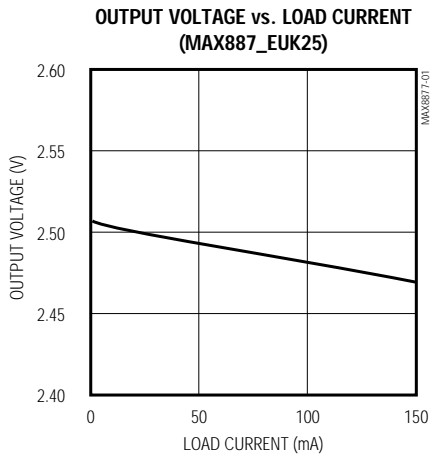

# Low-Noise, Low-Dropout, 150mA Linear Regulators with '2982 Pinout

## Typical Operating Characteristics (continued)

( $V_{IN} = V_{OUT(NOMINAL)} + 0.5V$ ,  $C_{IN} = 1\mu F$ ,  $C_{OUT} = 1\mu F$ ,  $C_{BP} = 0.01\mu F$ ,  $T_A = +25^\circ C$ , unless otherwise noted.)

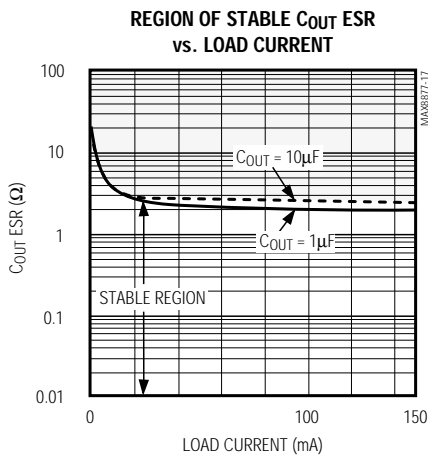
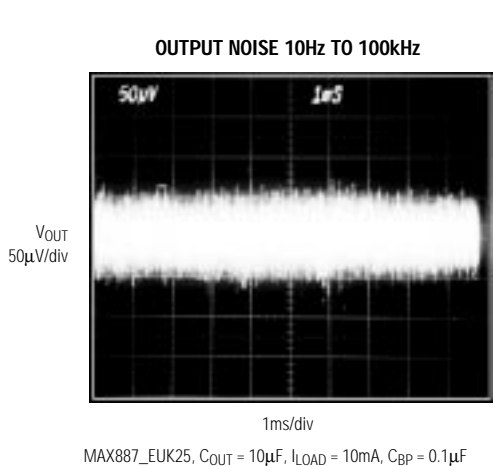
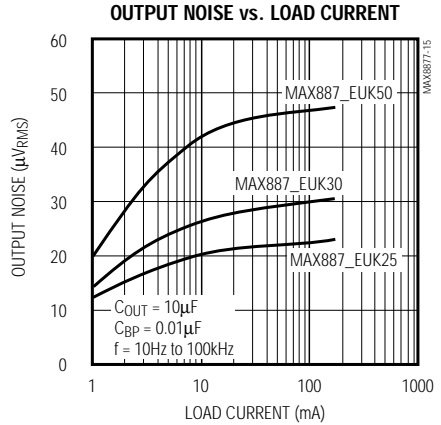
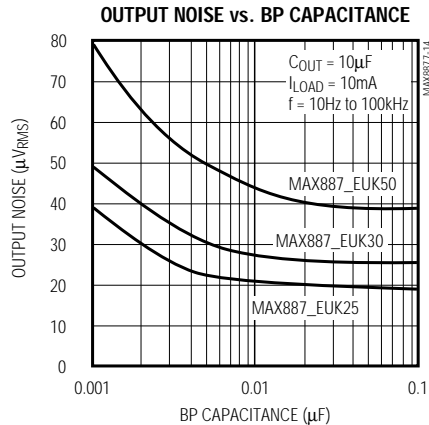
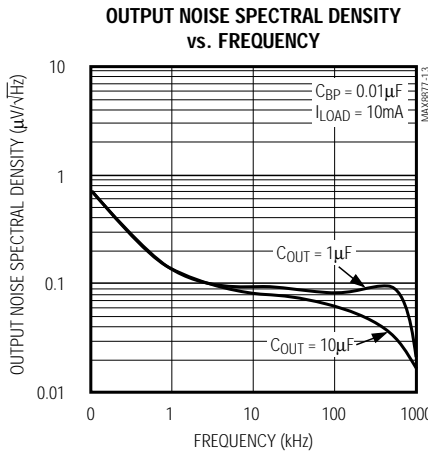
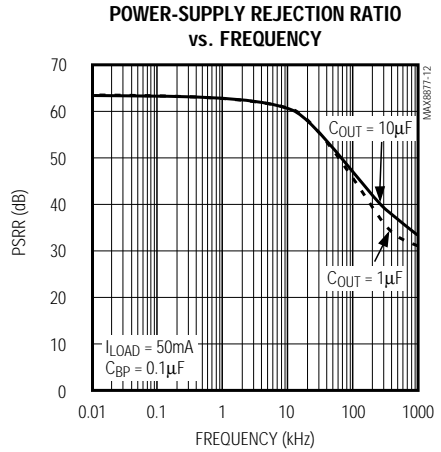
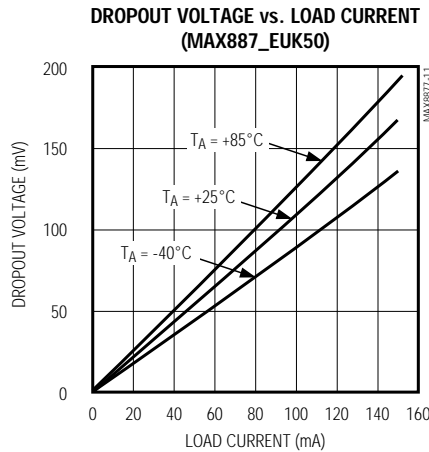
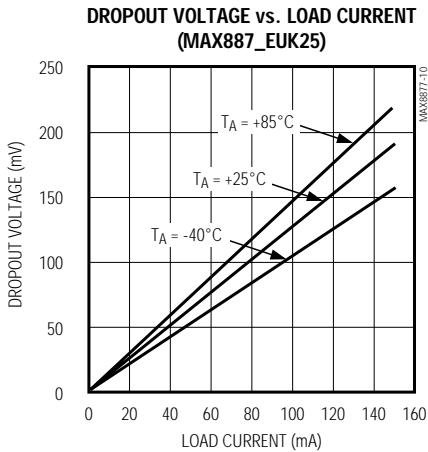

# Low-Noise, Low-Dropout, 150mA Linear Regulators with '2982 Pinout

MAX8877/MAX8878

## Typical Operating Characteristics (continued)

( $V_{IN} = V_{OUT(NOMINAL)} + 0.5V$ ,  $C_{IN} = 1\mu F$ ,  $C_{OUT} = 1\mu F$ ,  $C_{BP} = 0.01\mu F$ ,  $T_A = +25^\circ C$ , unless otherwise noted.)

**LINE-TRANSIENT RESPONSE**

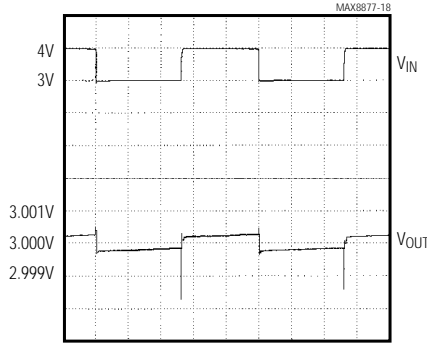

100µs/div  
MAX887\_EUK30,  $I_{LOAD} = 50mA$

**LOAD-TRANSIENT RESPONSE**

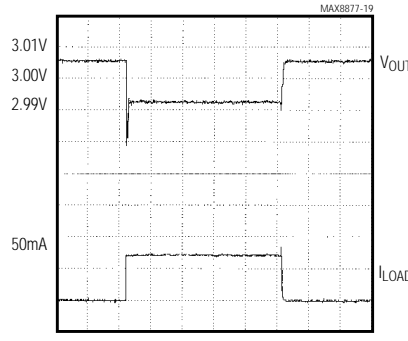

10µs/div  
MAX887\_EUK30,  $V_{IN} = V_{OUT} + 0.5V$ ,  
 $C_{IN} = 10\mu F$ ,  $I_{LOAD} = 0mA$  TO  $50mA$

**LOAD-TRANSIENT RESPONSE NEAR DROPOUT**

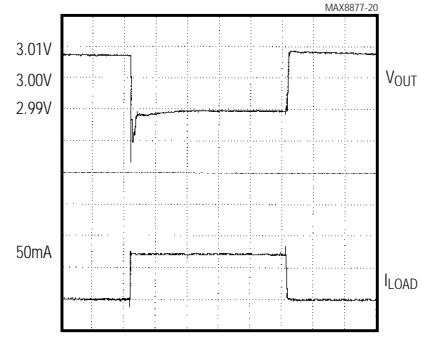

10µs/div  
MAX887\_EUK30,  $V_{IN} = V_{OUT} + 0.1V$ ,  
 $C_{IN} = 10\mu F$ ,  $I_{LOAD} = 0mA$  TO  $50mA$

**MAX887\_EUK25 SHUTDOWN EXIT DELAY**

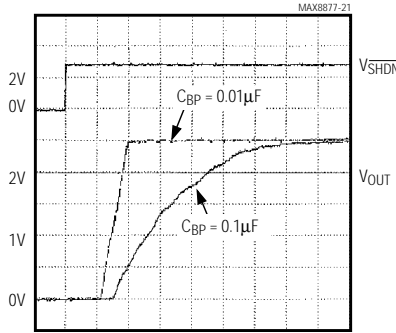

5µs/div  
MAX887\_EUK25,  $I_{LOAD} = 50mA$

**MAX887\_EUK50 SHUTDOWN EXIT DELAY**

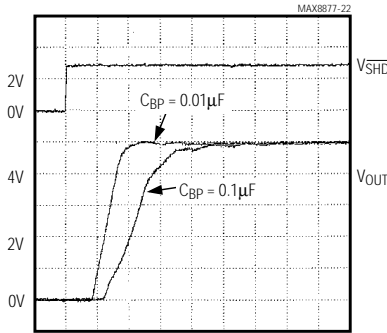

5µs/div  
MAX887\_EUK50,  $I_{LOAD} = 50mA$

**ENTERING SHUTDOWN**

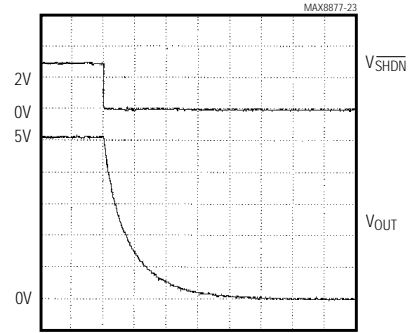

500µs/div  
MAX8878, NO LOAD

## Pin Description

PIN	NAME	FUNCTION
1	IN	Regulator Input. Supply voltage can range from 2.5V to 6.5V. Bypass with a 1µF capacitor to GND (see <i>Capacitor Selection and Regulator Stability</i> section).
2	GND	Ground. This pin also functions as a heatsink. Solder to a large pad or the circuit-board ground plane to maximize power dissipation.
3	$\overline{SHDN}$	Active-Low Shutdown Input. A logic low reduces the supply current to 10nA. On the MAX8878, a logic low also causes the output voltage to discharge to GND. Connect to IN for normal operation.
4	BP	Reference-Noise Bypass. Bypass with a low-leakage, 0.01µF ceramic capacitor for reduced noise at the output.
5	OUT	Regulator Output. Sources up to 150mA. Bypass with a 1µF (<math><0.2\Omega</math> typical ESR) capacitor to GND.

# Low-Noise, Low-Dropout, 150mA Linear Regulators with '2982 Pinout

## Detailed Description

The MAX8877/MAX8878 are low-noise, low-dropout, low-quiescent-current linear regulators designed primarily for battery-powered applications. The parts are available with preset output voltages ranging from 2.5V to 5V, in 100mV increments. These devices can supply loads up to 150mA. As illustrated in Figure 1, the MAX8877/MAX8878 consist of a 1.25V reference, error amplifier, P-channel pass transistor, and internal feedback voltage divider.

The 1.25V bandgap reference is connected to the error amplifier's inverting input. The error amplifier compares this reference with the feedback voltage and amplifies the difference. If the feedback voltage is lower than the reference voltage, the pass-transistor gate is pulled lower, which allows more current to pass to the output and increases the output voltage. If the feedback voltage is too high, the pass-transistor gate is pulled up, allowing less current to pass to the output. The output voltage is fed back through an internal resistor voltage divider connected to the OUT pin.

An external bypass capacitor connected to the BP pin reduces noise at the output. Additional blocks include a current limiter, reverse battery protection, thermal sensor, and shutdown logic. The MAX8878 also includes an auto-discharge function, which actively discharges the output voltage to ground when the device is placed in shutdown mode.

## Output Voltage

The MAX8877/MAX8878 are supplied with factory-set output voltages from 2.5V to 5.0V, in 100mV increments. Except for the MAX8877\_EUK29 and the MAX8877\_EUK32 (which have an output voltage preset at 2.84V and 3.15V, respectively), the two-digit suffix allows the customer to choose the output voltage in 100mV increments. For example, the MAX8877EUK33 has a preset output voltage of 3.3V (see *Expanded Ordering Information*).

## Internal P-Channel Pass Transistor

The MAX8877/MAX8878 feature a  $1.1\Omega$  typical P-channel MOSFET pass transistor. This provides several advantages over similar designs using PNP pass transistors, including longer battery life. The P-channel MOSFET requires no base drive, which reduces quiescent current considerably. PNP-based regulators waste considerable current in dropout when the pass transistor saturates. They also use high base-drive currents under large loads. The MAX8877/MAX8878 do not suffer from these problems and consume only 100 $\mu$ A of quiescent current whether in dropout, light-load, or heavy-load applications (see the *Typical Operating Characteristics*).

## Current Limit

The MAX8877/MAX8878 include a current limiter, which monitors and controls the pass transistor's gate voltage, limiting the output current to 390mA. For design purposes, consider the current limit to be 160mA minimum to 500mA maximum. The output can be shorted to ground for an indefinite amount of time without damaging the part.

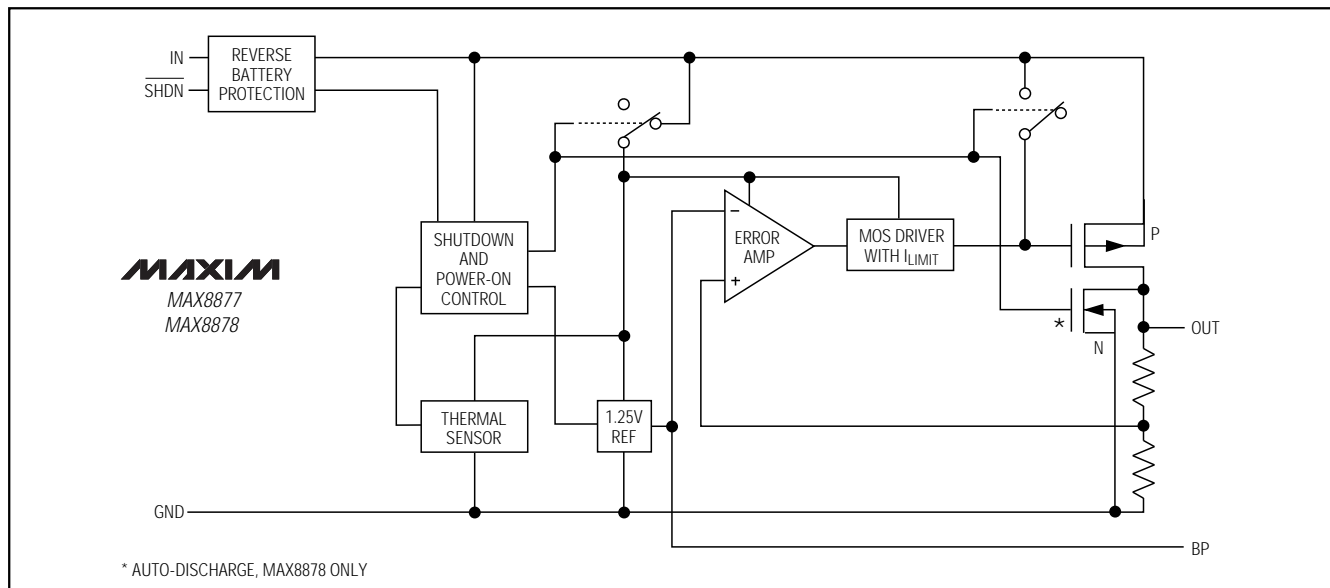

Figure 1. Functional Diagram

# Low-Noise, Low-Dropout, 150mA Linear Regulators with '2982 Pinout

## Thermal-Overload Protection

Thermal-overload protection limits total power dissipation in the MAX8877/MAX8878. When the junction temperature exceeds  $T_J = +155^\circ\text{C}$ , the thermal sensor signals the shutdown logic, turning off the pass transistor and allowing the IC to cool. The thermal sensor will turn the pass transistor on again after the IC's junction temperature cools by  $15^\circ\text{C}$ , resulting in a pulsed output during continuous thermal-overload conditions.

Thermal-overload protection is designed to protect the MAX8877/MAX8878 in the event of fault conditions. For continual operation, do not exceed the absolute maximum junction-temperature rating of  $T_J = +150^\circ\text{C}$ .

## Operating Region and Power Dissipation

The MAX8877/MAX8878's maximum power dissipation depends on the thermal resistance of the case and circuit board, the temperature difference between the die junction and ambient air, and the rate of air flow. The power dissipation across the device is  $P = I_{\text{OUT}}(V_{\text{IN}} - V_{\text{OUT}})$ . The maximum power dissipation is:

$$P_{\text{MAX}} = (T_J - T_A) / (\theta_{\text{JB}} + \theta_{\text{BA}})$$

where  $T_J - T_A$  is the temperature difference between the MAX8877/MAX8878 die junction and the surrounding air,  $\theta_{\text{JB}}$  (or  $\theta_{\text{JC}}$ ) is the thermal resistance of the package, and  $\theta_{\text{BA}}$  is the thermal resistance through the printed circuit board, copper traces, and other materials to the surrounding air.

The GND pin of the MAX8877/MAX8878 performs the dual function of providing an electrical connection to ground and channeling heat away. Connect the GND pin to ground using a large pad or ground plane.

## Reverse Battery Protection

The MAX8877/MAX8878 have a unique protection scheme that limits the reverse supply current to 1mA when either  $V_{\text{IN}}$  or  $V_{\text{SHDN}}$  falls below ground. Their circuitry monitors the polarity of these two pins and disconnects the internal circuitry and parasitic diodes when the battery is reversed. This feature prevents device damage.

## Noise Reduction

An external  $0.01\mu\text{F}$  bypass capacitor at BP, in conjunction with an internal  $200\text{k}\Omega$  resistor, creates a 80Hz low-pass filter for noise reduction. The MAX8877/MAX8878 exhibit  $30\mu\text{V}_{\text{RMS}}$  of output voltage noise with  $C_{\text{BP}} = 0.01\mu\text{F}$  and  $C_{\text{OUT}} = 10\mu\text{F}$ . This is negligible in most applications. Start-up time is minimized by a power-on circuit that pre-charges the bypass capacitor. The *Typical Operating Characteristics* section shows graphs of Noise vs. BP Capacitance, Noise vs. Load Current, and Output Noise Spectral Density.

## Applications Information

### Capacitor Selection and Regulator Stability

Normally, use a  $1\mu\text{F}$  capacitor on the MAX8877/MAX8878's input and a  $1\mu\text{F}$  to  $10\mu\text{F}$  capacitor on the output. Larger input capacitor values and lower ESRs provide better supply-noise rejection and line-transient response. Reduce noise and improve load-transient response, stability, and power-supply rejection by using large output capacitors. For stable operation over the full temperature range and with load currents up to 150mA, a minimum of  $1\mu\text{F}$  is recommended.

Note that some ceramic dielectrics exhibit large capacitance and ESR variation with temperature. With dielectrics such as Z5U and Y5V, it may be necessary to use  $2.2\mu\text{F}$  or more to ensure stability at temperatures below  $-10^\circ\text{C}$ . With X7R or X5R dielectrics,  $1\mu\text{F}$  should be sufficient at all operating temperatures. Also, for high-ESR tantalum capacitors,  $2.2\mu\text{F}$  or more may be needed to maintain ESR in the stable region. A graph of the Region of Stable  $C_{\text{OUT}}$  ESR vs. Load Current is shown in the *Typical Operating Characteristics*.

Use a  $0.01\mu\text{F}$  bypass capacitor at BP for low output voltage noise. Increasing the capacitance will slightly decrease the output noise, but increase the start-up time. Values above  $0.1\mu\text{F}$  provide no performance advantage and are not recommended (see Shutdown Exit Delay graphs in the *Typical Operating Characteristics*).

### PSRR and Operation from Sources Other than Batteries

The MAX8877/MAX8878 are designed to deliver low dropout voltages and low quiescent currents in battery-powered systems. Power-supply rejection is 63dB at low frequencies and rolls off above 10kHz. See the Power-Supply Rejection Ratio Frequency graph in the *Typical Operating Characteristics*.

When operating from sources other than batteries, improved supply-noise rejection and transient response can be achieved by increasing the values of the input and output bypass capacitors, and through passive filtering techniques. The *Typical Operating Characteristics* show the MAX8877/MAX8878's line- and load-transient responses.

### Load-Transient Considerations

The MAX8877/MAX8878 load-transient response graphs (see *Typical Operating Characteristics*) show two components of the output response: a DC shift from the output impedance due to the load current change, and the transient response. Typical transient

# Low-Noise, Low-Dropout, 150mA Linear Regulators with '2982 Pinout

for a step change in the load current from 0mA to 50mA is 12mV. Increasing the output capacitor's value and decreasing the ESR attenuates the overshoot.

### Input-Output (Dropout) Voltage

A regulator's minimum input-output voltage differential (or dropout voltage) determines the lowest usable sup-

ply voltage. In battery-powered systems, this will determine the useful end-of-life battery voltage. Because the MAX8877/MAX8878 use a P-channel MOSFET pass transistor, their dropout voltage is a function of drain-to-source on-resistance ( $R_{DS(ON)}$ ) multiplied by the load current (see *Typical Operating Characteristics*).

### Chip Information

TRANSISTOR COUNT: 247

SUBSTRATE CONNECTED TO GND

### Expanded Ordering Information

OUTPUT VOLTAGE (xy) CODE	PRESET OUTPUT VOLTAGE (V)	SOT TOP MARK	
		MAX8877	MAX8878
MAX887_EUK25-T	2.50	ACBM	ACBT
MAX887_EUK28-T	2.80	ACBN	ACBU
MAX887_EUK29-T	2.84	ACBO	ACBV
MAX887_EUK30-T	3.00	ACBP	ACBW
MAX887_EUK32-T	3.15	ACBQ	ACBX
MAX887_EUK33-T	3.30	ACBR	ACBY
MAX887_EUK36-T	3.60	ACDB	ACDC
MAX887_EUK50-T	5.00	ACBS	ACBZ
Other xy***	x.y0	—	—

\*\*\*Other xy between 2.5V and 5.0V are available in 100mV increments. Contact factory for other versions. Minimum order quantity is 25,000 units.

### Package Information

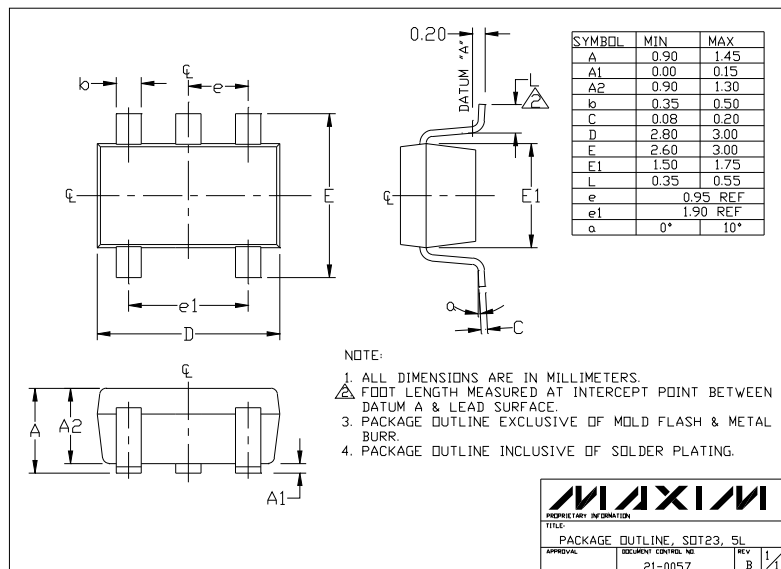

Maxim cannot assume responsibility for use of any circuitry other than circuitry entirely embodied in a Maxim product. No circuit patent licenses are implied. Maxim reserves the right to change the circuitry and specifications without notice at any time.

8 Maxim Integrated Products, 120 San Gabriel Drive, Sunnyvale, CA 94086 408-737-7600