

**Power entry module, for high current
Type EC12**

- Panel mount: screw-on version, front-side
- Appliance inlet with line switch 2-pole and line filter

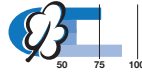

Standard or
Medical filter

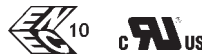

Characteristics

- Line switch non-illuminated. Illuminated version on request.
- All single elements wired
- With EMC-shield
- Qualified for use in equipment according to IEC/EN 60950

Technical data

Rated voltage	125/250 VAC; 50/60 Hz
Rated current	12/16 A @T _a 40 °C; VDE (ENEC) 12/16/20 A @T _a 40 °C; UL/CSA
Leakage current, Standard Medical	< 0,5 mA (250 V/60 Hz) < 5 µA (250 V/60 Hz)
Test voltage (2 sec)	1,7 kVDC between L-N 2,7 kVDC between L/N-PE
Allowable ambient air temperatures T _a	-25 °C to +85 °C
Climatic category	25/085/21 acc. to IEC/EN 60068-1
Degree of protection (front-side)	IP40 acc. to IEC 60529
Protection class	suitable for equipment with prot. cl. I, acc. to IEC 61140
Terminals	Quick-connect 6,3 x 0,8 mm
Panel thickness s	max. 8 mm
Materials: Housing	Thermoplastic, black, UL94 V-0

Appliance-inlet		acc. to IEC/EN 60320-1/C20, Protection class I, pin-temperature 70 °C (cold condition)
Line switch (Rocker switch)		2-pole, non-illuminated, acc. to IEC/EN 61058-1. Technical details see page 201
Line filter, standard and medical		acc.to IEC 60939, EN 133 200, UL 1283, CSA C22.2 no. 8 Technical details see page 202

Dimensions

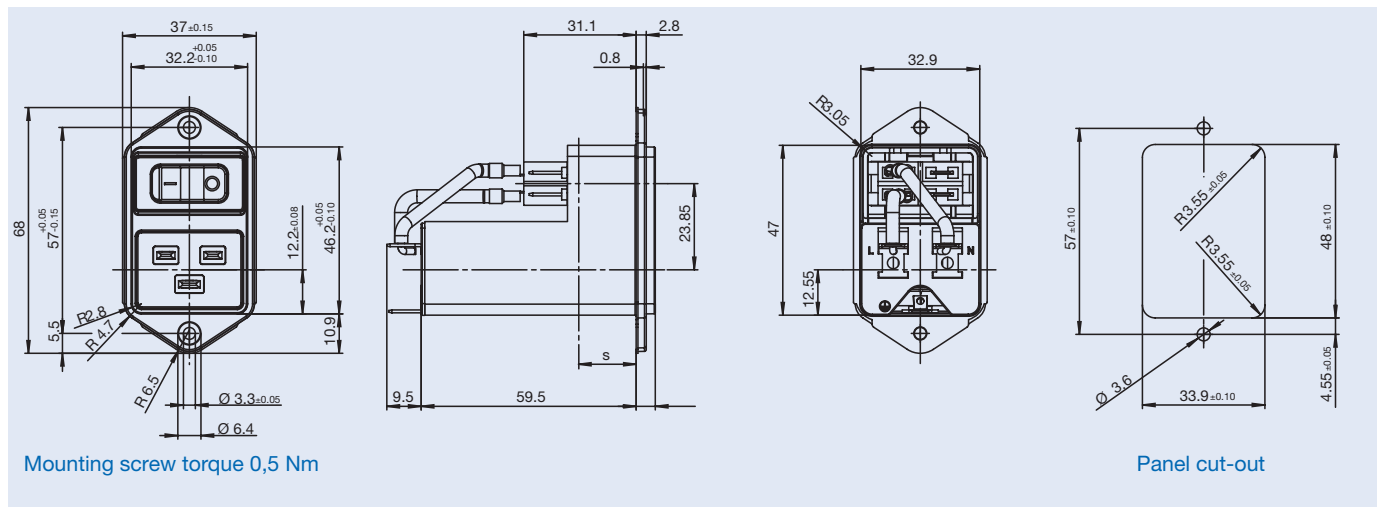

Diagrams

Line switch non-illuminated

Standard version

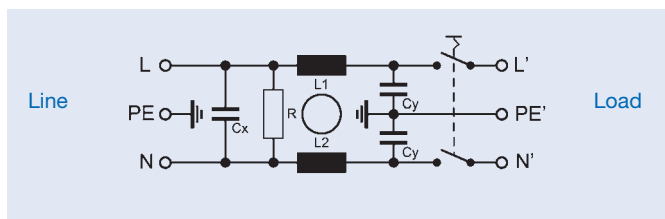

Medical version

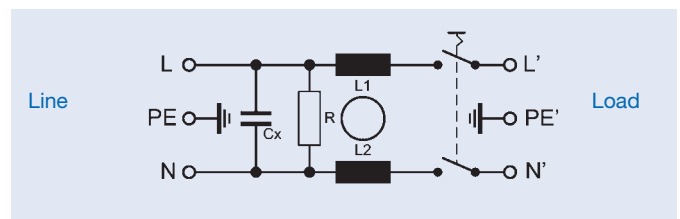

Technical data of filter-components

Rated current (A)	Filter-Type	Inductance L1/L2 (mH)	Capacitance		R (MΩ)
			CX (nF)	CY (nF)	
12	Standard	2 x 0,8	100	2 x 2,2	1
16		2 x 0,6			
20		2 x 0,3			
12	Medical	2 x 0,8	100		1
16		2 x 0,6			
20		2 x 0,3			

Attenuation loss line filter

Standard version

differential mode
common mode ———

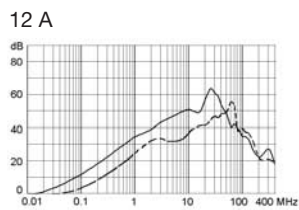

Medical version

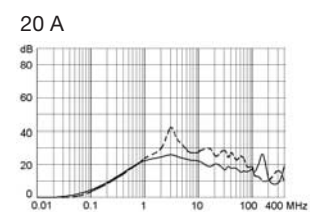
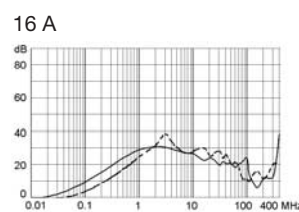
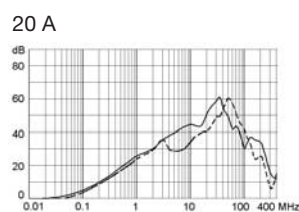
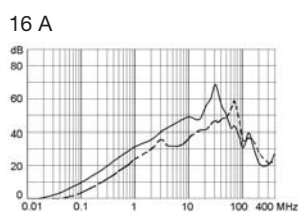
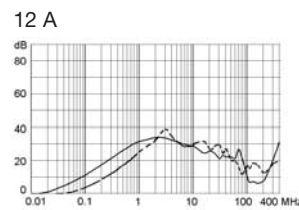

Order Numbers

Order no	Filter-Type	Rated current	Line switch non-illuminated	Screw-on
EC12.1101.001	Standard	20 A	•	•
EC12.2101.001		16 A	•	•
EC12.3101.001		12 A	•	•
EC12.1201.001	Medical	20 A	•	•
EC12.2201.001		16 A	•	•
EC12.3201.001		12 A	•	•

Other versions on request:

- Line switch illuminated
- Line switch with other rocker marking