



## Product Features

- 1.9 GHz Power Amp Module
- +34 dBm Linear Output Power
- 33 dB Gain
- Single +10V Supply
- No negative voltage required
- Low cost metal package
- MTTF > 100 Years

## Applications

- PAS Base Stations
- Repeaters

## Product Description

The ECM168 is a high performance PAS Amplifier Module offering excellent linearity. The internally matched multi-stage amplifier has 33.5 dB gain while achieving +34 dBm linear output power to meet PHS requirements of better than -65 dBc ACLR at a  $\pm 600$  kHz offset from the carrier.

The ECM168 uses a high reliability InGaP/GaAs HBT process technology and does not require any external matching components. The module has an added benefit by not require any negative biasing voltages; an internal active bias allows the ECM168 to maintain high linearity over temperature and operate directly off a single +10V supply. A low-cost metal housing allows the device to have a low thermal resistance and achieves over 100 years MTTF. All devices are 100% RF and DC tested.

The ECM168 is targeted for use as a driver amplifier in wireless infrastructure where high linearity and high power is required. This combination makes the device an excellent candidate for next generation PAS base stations.

## Functional Diagram

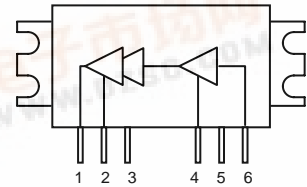

Top View

Pin No.	Function
1	RF Output
2	Vcc2
3	No Connect
4	Vcc1
5	No Connect
6	RF Input
Case	Ground

## Specifications <sup>(1)</sup>

Parameter	Symbol	Units	Min	Typ	Max	Test Conditions
Frequency	f	MHz	1880 - 1920			
Power Gain	Ga	dB	32.5	33.5	35.5	Pout = +34 dBm, Vd = 10V
ACLR ( $\pm 600$ kHz)	Padj1	dBc		-67 -69	-65	Pout = +34 dBm, Vd = 10V Pout = +33.5 dBm, Vd = 10V
ACLR ( $\pm 900$ kHz)	Padj2	dBc		-74	-70	Pout = +34 dBm, Vd = 10V
Input VSWR				1.5		Pout = +34 dBm, Vd = 10V
2 <sup>nd</sup> Order Harmonic Distortion	2fo	dBc		-50		Pout = +34 dBm, Vd = 10V
3 <sup>rd</sup> Order Harmonic Distortion	3fo	dBc		-50		Pout = +34 dBm, Vd = 10V
Supply Voltage	Vcc1, Vcc2	V		+10		
Supply Current	Id	mA	1000	1100	1300	

1. Test conditions unless otherwise noted: 25° C, Supply Voltage = +10 V, Output Power = +34 dBm, RF signal modulation is per PHS RCR-28.

## Absolute Maximum Rating

Parameter	Rating
Operating Case Temperature	-35 to +55 °C
Storage Temperature	-55 to +150 °C
Input RF Power	+10 dBm
Supply Voltage	+12 V

Operation of this device above any of these parameters may cause permanent damage.

## Ordering Information

Part No.	Description
ECM168	PHS +34 dBm 10V Module
ECM168-PCB	Fully Assembled Evaluation Board

## Recommended Application Circuit

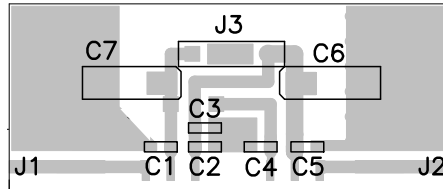
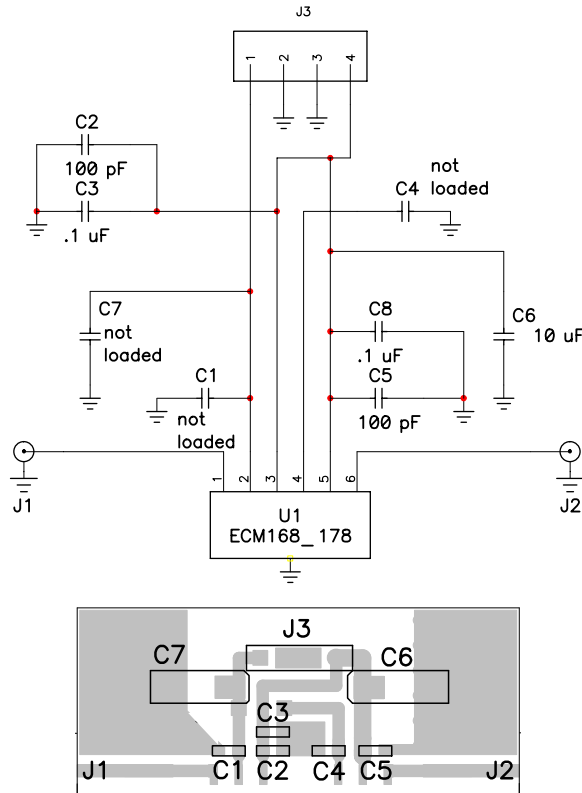

Please note that for reliable operation, the evaluation board will have to be mounted to a much larger heat sink during operation and in laboratory environments to dissipate the power consumed by the device. The use of a convection fan is also recommended in laboratory environments.

## Performance Graphs

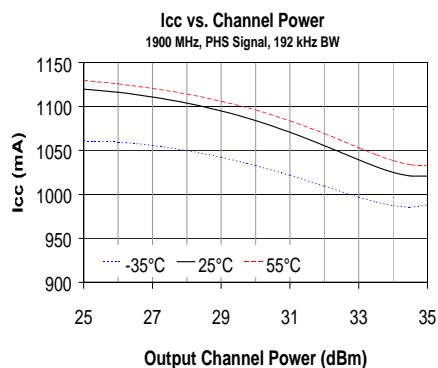
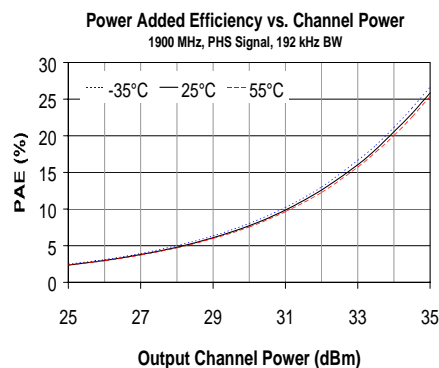
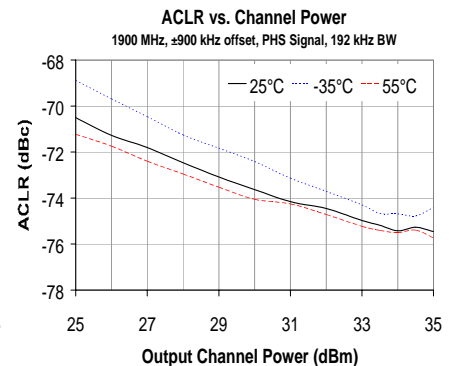
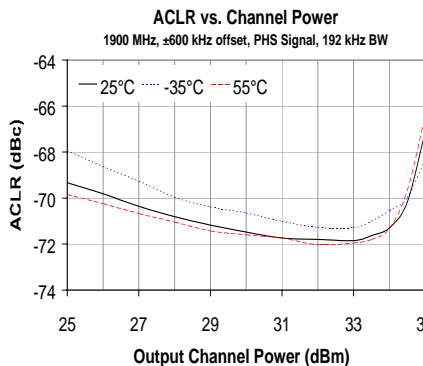
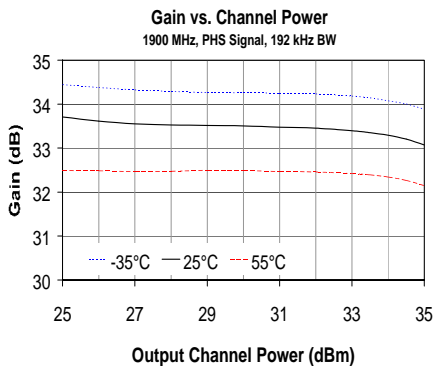

### Outline Drawing

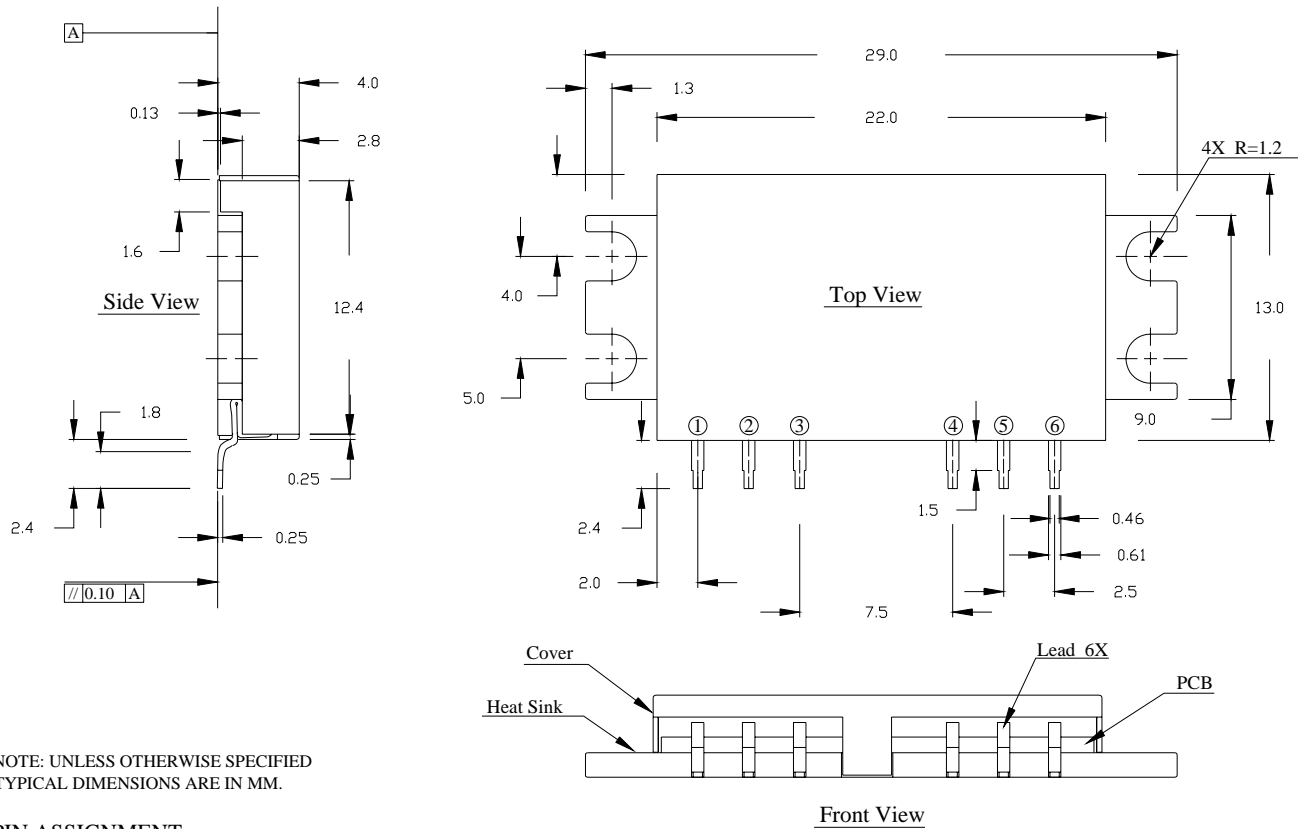

NOTE: UNLESS OTHERWISE SPECIFIED  
TYPICAL DIMENSIONS ARE IN MM.

#### PIN ASSIGNMENT

- (1) RFout, (2) Vcc2, (3) N/C,
- (4) Vcc1, (5) N/C, (6) RFin, Case:GND.