

Opto-Switch

EE-SX1025

Transmissive

- Phototransistor output.
- 5.4-mm-tall low profile model.
- PCB mounting type.
- High resolution with a 0.5-mm-wide aperture.
- 2.8mm slot width.
- Off-centre location pip for correct orientation.



Dimensions

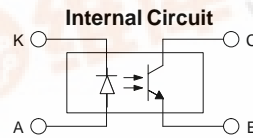
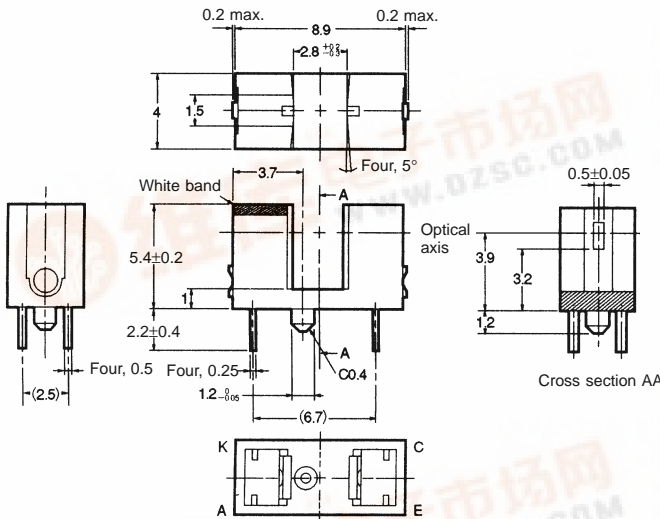

Terminal No.	Name
A	Anode
K	Cathode
C	Collector
E	Emitter

Unless otherwise specified, the tolerances are as shown below.

Dimensions	Tolerance
3 mm max.	±0.3
3 < mm ≤ 6	±0.375
6 < mm ≤ 10	±0.45
10 < mm ≤ 18	±0.55
18 < mm ≤ 30	±0.65

Specifications

■ Absolute Maximum Ratings (Ta = 25°C)

Item	Symbol	Rated value	
Emitter	Forward current	I_F	50 mA (see note 1)
	Pulse forward current	I_{FP}	1 A (see note 2)
	Reverse voltage	V_R	4 V
Detector	Collector-Emitter voltage	V_{CEO}	30 V
	Emitter-Collector voltage	V_{ECO}	---
	Collector current	I_C	20 mA
	Collector dissipation	P_C	100 mW (see note 1)
Ambient temperature	Operating	T_{opr}	-25°C to 85°C
	Storage	T_{stg}	-30°C to 100°C
	Soldering	T_{sol}	260°C

Note: 1.Refer to the temperature rating chart if the ambient temperature exceeds 25°C.
2.The pulse width is 10 μs maximum with a frequency of 100 Hz.

Electrical and Optical Characteristics (Ta = 25°C)

Item		Symbol	Value	Condition
Emitter	Forward voltage	V_F	1.2 V typ., 1.5 V max.	$I_F = 30 \text{ mA}$
	Reverse current	I_R	0.01 μA typ., 10 μA max.	$V_R = 4 \text{ V}$
	Peak emission wavelength	λ_P	940 nm typ.	$I_F = 20 \text{ mA}$
Detector	Light current	I_L	0.5 mA min., 14 mA max.	$I_F = 20 \text{ mA}, V_{CE} = 10 \text{ V}$
	Dark current	I_D	2 nA typ., 200 nA max.	$V_{CE} = 10 \text{ V}, 0 \ell x$
	Leakage current	I_{LEAK}	---	---
	Collector-Emitter saturated voltage	$V_{CE}(\text{sat})$	0.1 V typ., 0.4 V max.	$I_F = 20 \text{ mA}, I_L = 0.1 \text{ mA}$
	Peak spectral sensitivity wavelength	λ_P	850 nm typ.	$V_{CE} = 10 \text{ V}$
Rising time		t_r	4 μs typ.	$V_{CC} = 5 \text{ V}, R_L = 100 \Omega, I_L = 5 \text{ mA}$
Falling time		t_f	4 μs typ.	$V_{CC} = 5 \text{ V}, R_L = 100 \Omega, I_L = 5 \text{ mA}$

Engineering Data

Forward Current vs. Collector Dissipation Temperature Rating

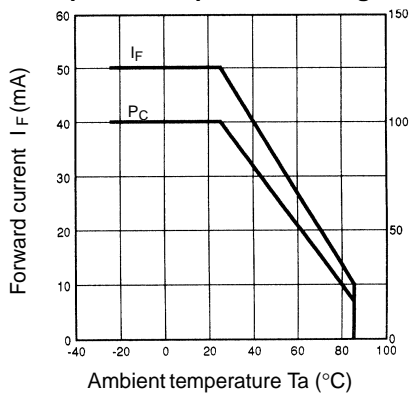

Forward Current vs. Forward Voltage Characteristics (Typical)

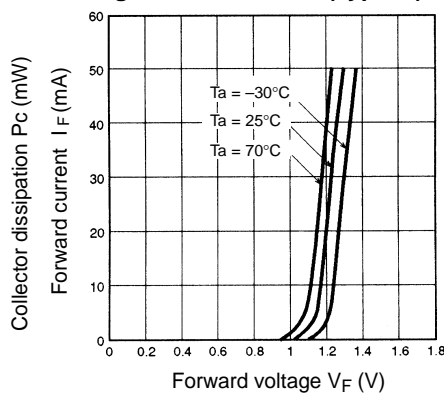

Light Current vs. Forward Current Characteristics (Typical)

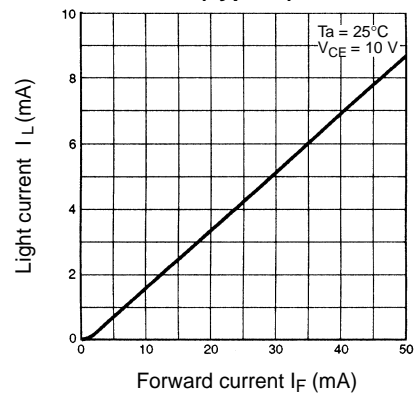

Light Current vs. Collector-Emitter Voltage Characteristics (Typical)

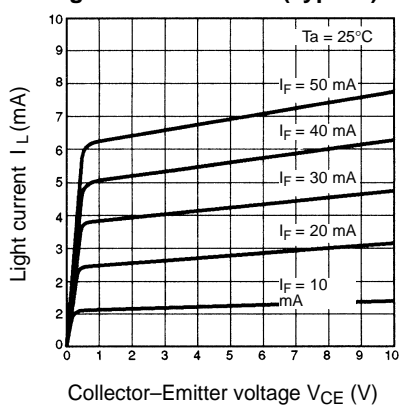

Relative Light Current vs. Ambient Temperature Characteristics (Typical)

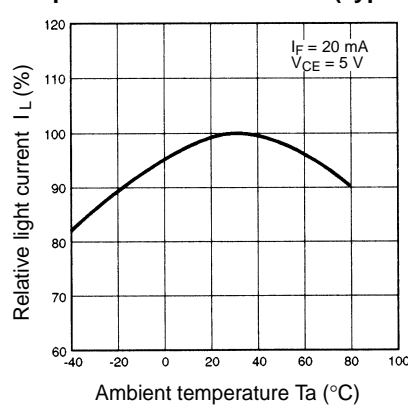

Dark Current vs. Ambient Temperature Characteristics (Typical)

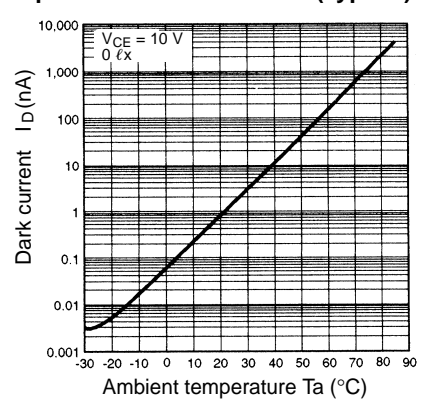

Response Time vs. Load Resistance Characteristics (Typical)

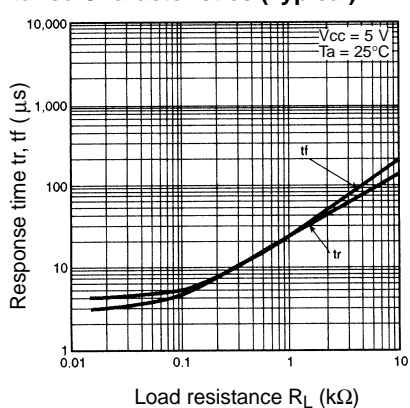

Sensing Position Characteristics (Typical)

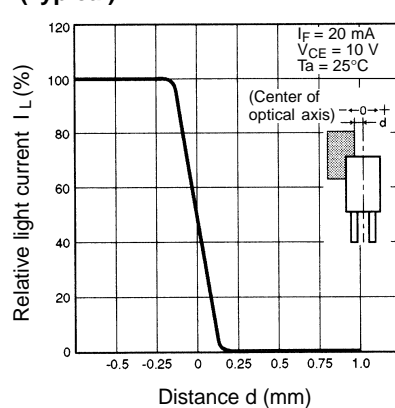

Response Time Measurement Circuit

