

19-1296; Rev 1; 1/98

EVALUATION KIT MANUAL  
FOLLOWS DATA SHEET

**MAXIM**

# Low-Voltage IF Transceiver with Limiter/RSSI and Quadrature Modulator

## General Description

The MAX2510 is a highly integrated IF transceiver for digital wireless applications. It operates from a +2.7V to +5.5V supply voltage and features four operating modes for advanced system power management. Supply current is reduced to 0.2µA in shutdown mode.

In a typical application, the receiver downconverts a high IF/RF (up to 600MHz) to a low IF (up to 30MHz) using a double-balanced mixer. Additional functions included in the receiver section are an IF buffer that can drive an off-chip filter, an on-chip limiting amplifier offering 90dB of received-signal-strength indication (RSSI), and a robust differential limiter output driver designed to directly drive a CMOS input. The transmitter section upconverts I and Q baseband signals to an IF in the 100MHz to 600MHz range using a quadrature modulator. The transmit output is easily matched to drive a SAW filter with an adjustable output from 0dBm to -40dBm and excellent linearity.

The MAX2511 has features similar to the MAX2510, but upconverts a low IF with an image-reject mixer. The MAX2511 downconverter also offers image rejection with a limiter/RSSI stage similar to that of the MAX2510.

## Applications

- PWT1900, Wireless Handsets, and Base Stations
- PACS, PHS, DECT, and Other PCS Wireless Handsets and Base Stations
- 400MHz ISM Transceivers
- IF Transceivers
- Wireless Data Links

Typical Operating Circuit appears on last page.

## Features

- ◆ +2.7V to +5.5V Single-Supply Operation
- ◆ Complete Receive Path: 600MHz (max) 1st IF to 30MHz (max) 2nd IF
- ◆ Unique, Wide-Dynamic-Range Downconverter Mixer Offers -8dBm IIP3, 11dB NF
- ◆ 90dB Dynamic-Range Limiter with High-Accuracy RSSI Function
- ◆ Differential Limiter Output Directly Drives CMOS Input
- ◆ 100MHz to 600MHz Transmit Quadrature Modulator with 41dB Sideband Suppression
- ◆ 40dB Transmit Gain-Control Range; Up to +1dBm Output Power
- ◆ Advanced Power Management (four modes)
- ◆ 0.2µA Shutdown Supply Current

## Ordering Information

PART	TEMP. RANGE	PIN-PACKAGE
MAX2510EEI	-40°C to +85°C	28 QSOP

## Pin Configuration

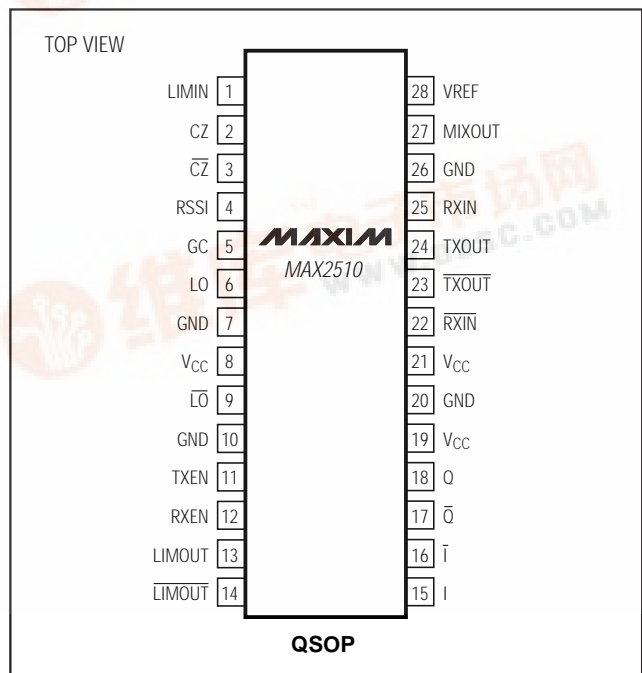

MAX2510



# Low-Voltage IF Transceiver with Limiter/RSSI and Quadrature Modulator

## ABSOLUTE MAXIMUM RATINGS

V <sub>CC</sub> to GND .....	-0.3V to 8.0V	RXEN, TXEN, GC Input Current .....	1mA
V <sub>CC</sub> to Any Other V <sub>CC</sub> .....	±0.3V	RSSI Voltage.....	-0.3V to (V <sub>CC</sub> + 0.3V)
I, $\bar{I}$ , Q, $\bar{Q}$ to GND .....	-0.3V to (V <sub>CC</sub> + 0.3V)	Continuous Power Dissipation (T <sub>A</sub> = +70°C) QSOP (derate 10mW/°C above +70°C) .....	650mW
I to $\bar{I}$ , Q to $\bar{Q}$ Differential Voltage .....	±2V	Operating Temperature Range .....	-40°C to +85°C
RXIN to $\bar{R}XIN$ Differential Voltage .....	±2V	Junction Temperature .....	+150°C
LOIN to $\bar{L}OIN$ Differential Voltage .....	±2V	Storage Temperature Range .....	-65°C to +165°C
LIMIN Voltage .....	(VREF - 1.3V) to (VREF + 1.3V)	Lead Temperature (soldering, 10sec) .....	+300°C
RXEN, TXEN, GC Voltage.....	-0.3V to (V <sub>CC</sub> + 0.3V)		

Stresses beyond those listed under "Absolute Maximum Ratings" may cause permanent damage to the device. These are stress ratings only, and functional operation of the device at these or any other conditions beyond those indicated in the operational sections of the specifications is not implied. Exposure to absolute maximum rating conditions for extended periods may affect device reliability.

## DC ELECTRICAL CHARACTERISTICS

(V<sub>CC</sub> = +2.7V to +5.5V; 0.01μF across CZ and  $\bar{C}Z$ ; LO,  $\bar{L}O$  open; MIXOUT tied to VREF through a 165Ω resistor; GC = 0.5V; RXIN,  $\bar{R}XIN$  open; LIMIN tied through 50Ω to VREF; LIMOUT,  $\bar{L}IMOUT$  = open; RXEN, TXEN = high; bias voltage at I,  $\bar{I}$ , Q,  $\bar{Q}$  = 1.4V; T<sub>A</sub> = -40°C to +85°C; unless otherwise noted. Typical values are at T<sub>A</sub> = +25°C.)

PARAMETER	CONDITIONS	MIN	TYP	MAX	UNITS
Operating Voltage Range		2.7	3.0	5.5	V
Digital Input Voltage High	RXEN, TXEN	2.0			V
Digital Input Voltage Low	RXEN, TXEN			0.4	V
Digital Input Current High	RXEN, TXEN = 2.0V		6	30	μA
Digital Input Current Low	RXEN, TXEN = 0.4V	-5	0.1		μA
Supply Current	Receive mode, RXEN = high, TXEN = low		14	20	mA
	Transmit mode, RXEN = low, TXEN = high		17	25	
	Standby mode, RXEN = high, TXEN = high		0.5	1	μA
	Shutdown mode, RXEN = low, TXEN = low		0.2	5	
VREF Voltage		V <sub>CC</sub> / 2 - 100mV	V <sub>CC</sub> / 2	V <sub>CC</sub> / 2 + 100mV	V
GC Input Resistance	(Note 1)	50	85		kΩ

## AC ELECTRICAL CHARACTERISTICS

(MAX2510 test fixture; V<sub>CC</sub> = +3.0V; RXEN = TXEN = low; 0.01μF across CZ and  $\bar{C}Z$ ; MIXOUT tied to VREF through 165Ω resistor; TXOUT and  $\bar{T}XOUT$  loaded with 100Ω differential; LO terminated with 50Ω,  $\bar{L}O$  AC grounded; GC open; LIMOUT,  $\bar{L}IMOUT$  are AC coupled to 250Ω load; 330pF at RSSI pin; 0.1μF connected from VREF pin to GND; P<sub>RXIN</sub>,  $\bar{P}R\bar{X}IN$  = -30dBm differentially driven (input matched); f<sub>RXIN</sub>,  $\bar{f}R\bar{X}IN$  = 240MHz; bias voltage at I,  $\bar{I}$ , Q,  $\bar{Q}$  = 1.4V; V<sub>I,Q</sub> = 500mVp-p; f<sub>I,Q</sub> = 200kHz; f<sub>LO</sub>,  $\bar{f}L\bar{O}$  = 230MHz; P<sub>LO</sub> = -13dBm; T<sub>A</sub> = +25°C; unless otherwise noted.)

PARAMETER	CONDITIONS	MIN	TYP	MAX	UNITS
<b>DOWNCONVERTER</b> (RXEN = high)					
Input Frequency Range	(Note 2)	100		600	MHz
Conversion Gain	T <sub>A</sub> = +25°C	20.5	22.5	25	dB
	T <sub>A</sub> = -40°C to +85°C (Note 3)	19.9		25.5	
Noise Figure	Single sideband		11		dB
Input 1dB Compression Point	(Note 4)		-18.5		dBm
Input Third-Order Intercept	Two tones at 240MHz and 240.2MHz, -30dBm per tone		-8		dBm
LO to RXIN Isolation			49		dBc
Power-Up Time	Standby to RX or TX (Note 5)			5	μs

# Low-Voltage IF Transceiver with Limiter/RSSI and Quadrature Modulator

MAX2510

## AC ELECTRICAL CHARACTERISTICS (continued)

(MAX2510 test fixture;  $V_{CC} = +3.0V$ ;  $R_{XEN} = TXEN = \text{low}$ ;  $0.01\mu F$  across  $CZ$  and  $\overline{CZ}$ ; MIXOUT tied to VREF through  $165\Omega$  resistor; TXOUT and  $\overline{TXOUT}$  loaded with  $100\Omega$  differential; LO terminated with  $50\Omega$ ,  $\overline{LO}$  AC grounded; GC open; LIMOUT,  $\overline{LIMOUT}$  are AC coupled to  $250\Omega$  load;  $330pF$  at RSSI pin;  $0.1\mu F$  connected from VREF pin to GND;  $P_{RXIN}, \overline{P_{RXIN}} = -30dBm$  differentially driven (input matched);  $f_{RXIN}, \overline{f_{RXIN}} = 240MHz$ ; bias voltage at I,  $\overline{I}$ , Q,  $\overline{Q} = 1.4V$ ;  $V_{I,Q} = 500mVp-p$ ;  $f_{I,Q} = 200kHz$ ;  $f_{LO}, \overline{f_{LO}} = 230MHz$ ;  $P_{LO} = -13dBm$ ;  $T_A = +25^\circ C$ ; unless otherwise noted.)

PARAMETER	CONDITIONS	MIN	TYP	MAX	UNITS
<b>LIMITING AMPLIFIER AND RSSI</b> ( $R_{XEN} = \text{high}$ , $f_{LIMIN} = 10MHz$ , $P_{LIMIN} = -30dBm$ from $50\Omega$ source, unless otherwise noted)					
Limiter Output Voltage Swing	LIMOUT, $\overline{LIMOUT}$	$\pm 270$	$\pm 300$	$\pm 350$	mV
Phase Variation	-75dBm to 5dBm		$\pm 4.5$		degrees
Minimum Linear RSSI Range	-75dBm to 5dBm		80		dB
Minimum Monotonic RSSI Range	-85dBm to 5dBm		90		dB
RSSI Slope	-75dBm to 5dBm from $50\Omega$		20		mV/dB
RSSI Maximum Zero-Scale Intercept	(Note 6)		-86		dBm
RSSI Relative Error (Notes 6, 7)	$T_A = +25^\circ C$		$\pm 0.5$	$\pm 2.0$	dB
	$T_A = -40^\circ C$ to $+85^\circ C$ (Note 3)			$\pm 3.0$	
Minimum-Scale RSSI Voltage	At LIMIN input of -75dBm		0.25		V
Maximum-Scale RSSI Voltage	At LIMIN input of +5dBm		1.8		V
<b>TRANSMITTER</b> ( $TXEN = \text{high}$ )					
Frequency Range	(Note 8)	100		600	MHz
I, $\overline{I}$ , Q, $\overline{Q}$ Allowable Common-Mode Voltage Range	I, $\overline{I}$ , Q, $\overline{Q}$ inputs are 250mVp-p centered around this voltage, GC = 2.0V (Note 9)	1.3		$V_{CC} - 1.2$	V
	I, Q are 500mVp-p while $\overline{I}$ , $\overline{Q}$ are held at this DC voltage (Note 9)	1.4		$V_{CC} - 1.3$	
Output Power	GC = 0.5V		-41		dBm
	GC = open		-16		
	GC = 2.0V (Note 9)	$T_A = +25^\circ C$	-2.5	1	
$T_A = -40^\circ C$ to $+85^\circ C$		-3			
I, $\overline{I}$ , Q, $\overline{Q}$ 1dB Bandwidth	(Note 3)	70	80		MHz
Unwanted Sideband Suppression	$90^\circ$ phase difference between I and Q inputs; GC = 2V	30	40		dBc
LO Rejection	$90^\circ$ phase difference between I and Q inputs; measured to fundamental tone; GC = 2V	30	44		dBc
Output IM3 Level	GC = 0.5V (Note 11)		-49		dBc
	GC = 2V (Note 11)		-33		
Output IM5 Level	GC = 2V (Note 11)		-51		dBc

**Note 1:** This pin is internally terminated to approximately 1.35V through the specified resistance.

**Note 2:** Downconverter gain is typically greater than 20dB. Operation outside this frequency range is possible but has not been characterized.

**Note 3:** Guaranteed by design and characterization.

# Low-Voltage IF Transceiver with Limiter/RSSI and Quadrature Modulator

- Note 4:** Driving RXIN or  $\overline{\text{RXIN}}$  with a power level greater than the 1dB compression level forces the input stage out of its linear range, causing harmonic and intermodulation distortion. The RSSI output increases monotonically with increasing input levels beyond the mixer's 1dB compression level. Input 1dB compression point is limited by MIXOUT voltage swing, which is approximately 2Vp-p into a 165 $\Omega$  load.
- Note 5:** Assuming the supply voltage has been applied, this includes limiter offset-correction settling and Rx or Tx bias stabilization time. Guaranteed by design and characterization.
- Note 6:** The RSSI maximum zero-scale intercept is the maximum (over a statistical sample of parts) input power at which the RSSI output would be 0V. This point is extrapolated from the linear portion of the RSSI Output Voltage vs. Limiter Input Power graph in the *Typical Operating Characteristics*. This specification and the RSSI slope define the RSSI function's ideal behavior (the slope and intercept of a straight line), while the RSSI relative error specification defines the deviations from this line. See the *Typical Operating Characteristics* for the RSSI Output Voltage vs. Limiter Input Power graph.
- Note 7:** The RSSI relative error is the deviation from the best-fitting straight line of the RSSI output voltage versus the limiter input power. This number represents the worst-case deviation at any point along this line. A 0dB relative error is exactly on the ideal RSSI transfer function. The limiter input power range for this test is -75dBm to 5dBm from 50 $\Omega$ . See the *Typical Operating Characteristics* for the RSSI Relative Error graph.
- Note 8:** Transmit sideband suppression is typically better than 35dB. Operation outside this frequency range is possible but has not been characterized.
- Note 9:** Output IM3 level is typically better than -29dBc.
- Note 10:** The output power can be increased by raising GC above 2V. Refer to the Transmitter Output Power vs. GC Voltage and Frequency graph in the *Typical Operating Characteristics*.
- Note 11:** Using two tones at 400kHz and 500kHz, 250mVp-p differential per tone at I,  $\overline{\text{I}}$ , Q,  $\overline{\text{Q}}$ .

## Typical Operating Characteristics

(MAX2510 EV kit;  $V_{CC} = +3.0\text{V}$ ; 0.01 $\mu\text{F}$  across CZ and  $\overline{\text{CZ}}$ ; MIXOUT tied to VREF through 165 $\Omega$  resistor; TXOUT and  $\overline{\text{TXOUT}}$  loaded with 100 $\Omega$  differential; LO terminated with 50 $\Omega$ ;  $\overline{\text{LO}}$  AC grounded; GC open; LIMOUT,  $\overline{\text{LIMOUT}}$  open; 330pF at RSSI pin; 0.1 $\mu\text{F}$  connected from VREF pin to GND;  $P_{\text{RXIN}}$ ,  $\overline{P_{\text{RXIN}}} = -30\text{dBm}$  differentially driven (input matched);  $f_{\text{RXIN}}$ ,  $\overline{f_{\text{RXIN}}} = 240\text{MHz}$ ; bias voltage at I,  $\overline{\text{I}}$ , Q,  $\overline{\text{Q}} = 1.4\text{V}$ ;  $V_{\text{I,Q}} = 500\text{mVp-p}$ ;  $f_{\text{I,Q}} = 200\text{kHz}$ ;  $f_{\text{LO}}$ ,  $\overline{f_{\text{LO}}} = 230\text{MHz}$ ;  $P_{\text{LO}} = -13\text{dBm}$ ;  $T_A = +25^\circ\text{C}$ ; unless otherwise noted.)

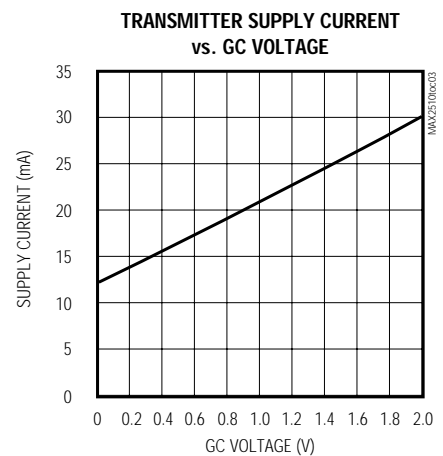
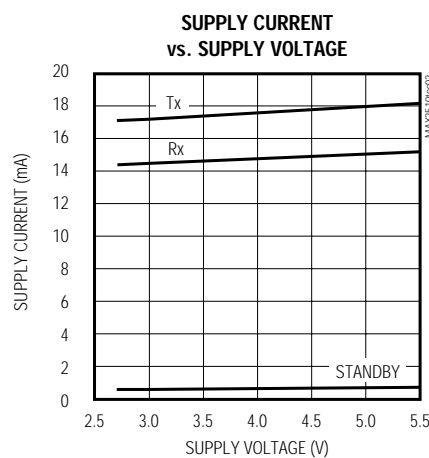
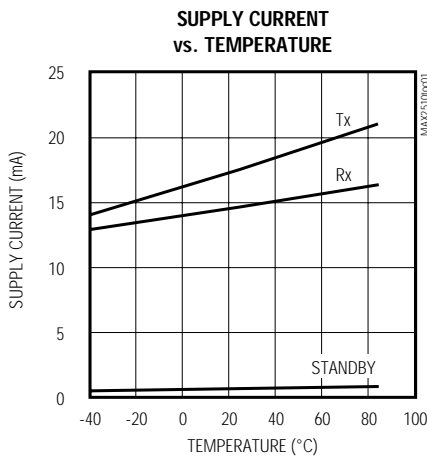

# Low-Voltage IF Transceiver with Limiter/RSSI and Quadrature Modulator

MAX2510

## Typical Operating Characteristics (continued)

(MAX2510 EV kit;  $V_{CC} = +3.0V$ ;  $0.01\mu F$  across  $\overline{CZ}$  and  $\overline{CZ}$ ; MIXOUT tied to VREF through  $165\Omega$  resistor; TXOUT and  $\overline{TXOUT}$  loaded with  $100\Omega$  differential; LO terminated with  $50\Omega$ ;  $\overline{LO}$  AC grounded; GC open; LIMOUT,  $\overline{LIMOUT}$  open;  $330pF$  at RSSI pin;  $0.1\mu F$  connected from VREF pin to GND;  $P_{RXIN}$ ,  $\overline{RXIN} = -30dBm$  differentially driven (input matched);  $f_{RXIN}$ ,  $\overline{f_{RXIN}} = 240MHz$ ; bias voltage at I,  $\overline{I}$ , Q,  $\overline{Q} = 1.4V$ ;  $V_{I,Q} = 500mVp-p$ ;  $f_{I,Q} = 200kHz$ ;  $f_{LO}$ ,  $\overline{f_{LO}} = 230MHz$ ;  $P_{LO} = -13dBm$ ;  $T_A = +25^\circ C$ ; unless otherwise noted.)

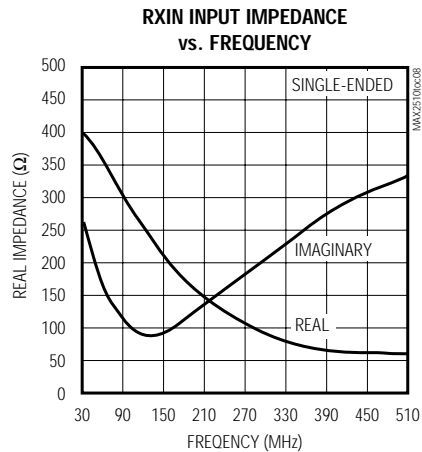
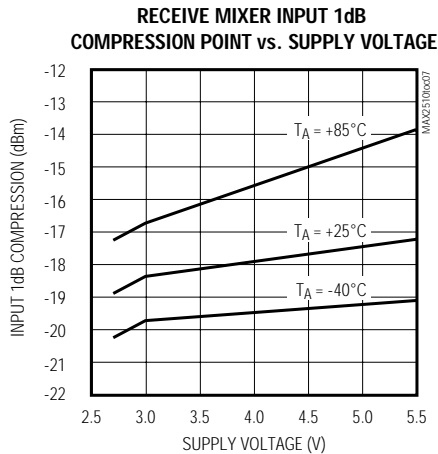
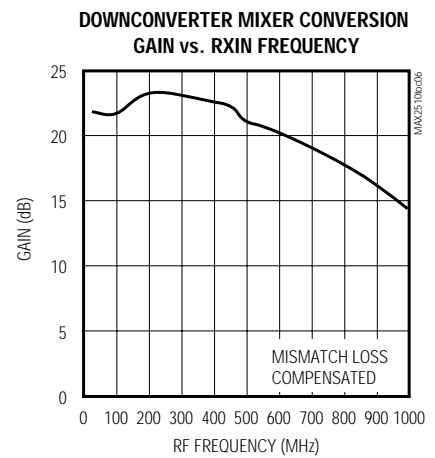
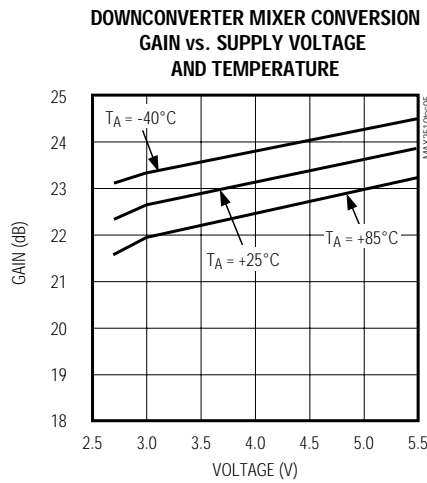
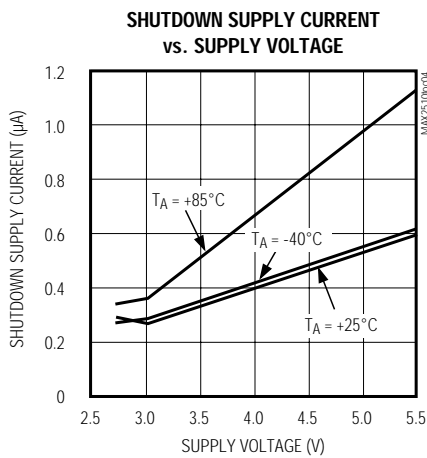

# Low-Voltage IF Transceiver with Limiter/RSSI and Quadrature Modulator

## Typical Operating Characteristics (continued)

(MAX2510 EV kit;  $V_{CC} = +3.0V$ ;  $0.01\mu F$  across CZ and  $\overline{CZ}$ ; MIXOUT tied to VREF through  $165\Omega$  resistor; TXOUT and  $\overline{TXOUT}$  loaded with  $100\Omega$  differential; LO terminated with  $50\Omega$ ;  $\overline{LO}$  AC grounded; GC open; LIMOUT,  $\overline{LIMOUT}$  open;  $330pF$  at RSSI pin;  $0.1\mu F$  connected from VREF pin to GND;  $P_{RXIN}$ ,  $\overline{RXIN} = -30dBm$  differentially driven (input matched);  $f_{RXIN}$ ,  $\overline{RXIN} = 240MHz$ ; bias voltage at I,  $\overline{I}$ , Q,  $\overline{Q} = 1.4V$ ;  $V_{I,Q} = 500mVp-p$ ;  $f_{I,Q} = 200kHz$ ;  $f_{LO}$ ,  $\overline{LO} = 230MHz$ ;  $P_{LO} = -13dBm$ ;  $T_A = +25^\circ C$ ; unless otherwise noted.)

**RSSI OUTPUT VOLTAGE vs. LIMIN INPUT POWER AND TEMPERATURE**

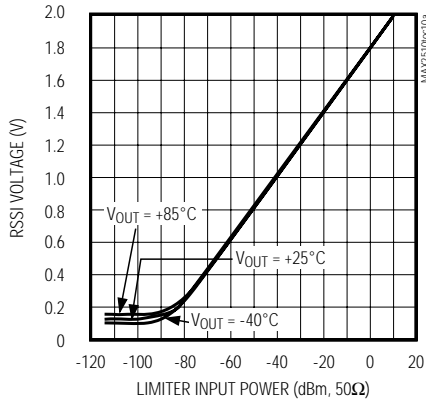

**RSSI RELATIVE ERROR vs. LIMIN INPUT POWER AND TEMPERATURE**

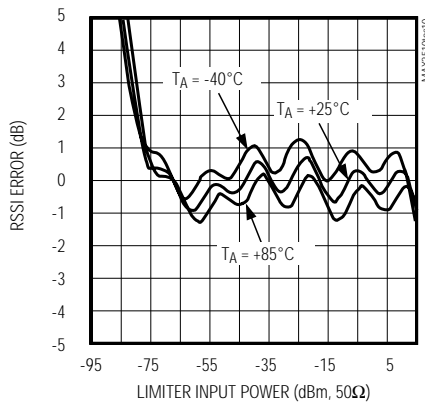

**RSSI OUTPUT VOLTAGE vs. RXIN INPUT POWER**

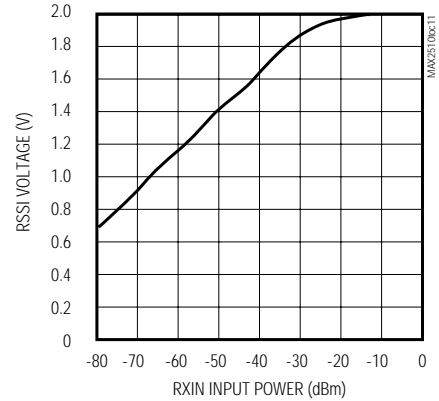

**TRANSMITTER OUTPUT POWER vs. GC VOLTAGE AND FREQUENCY**

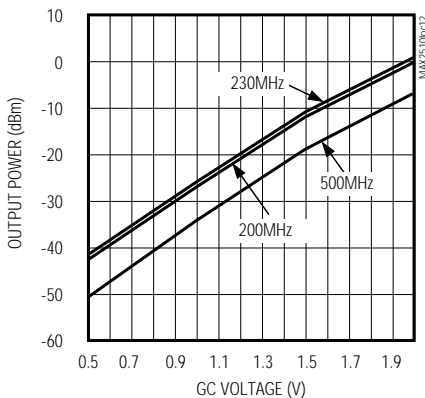

**TRANSMITTER OUTPUT POWER vs. FREQUENCY**

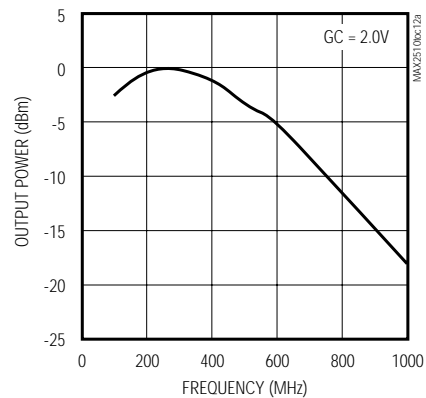

**TRANSMITTER IM3 LEVELS vs. GC VOLTAGE**

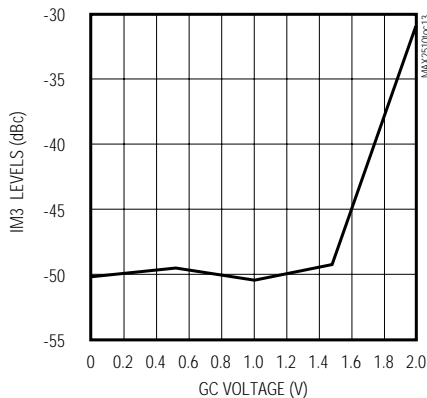

**TRANSMITTER OUTPUT 1dB COMPRESSION POINT vs. GC VOLTAGE**

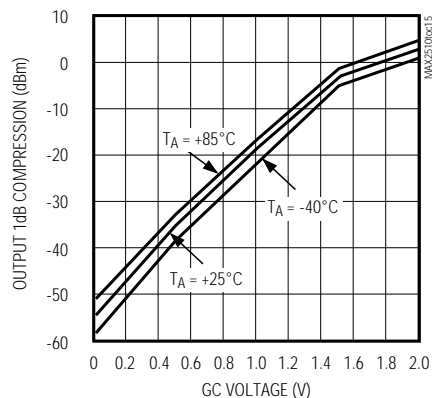

# Low-Voltage IF Transceiver with Limiter/RSSI and Quadrature Modulator

MAX2510

## Typical Operating Characteristics (continued)

(MAX2510 EV kit;  $V_{CC} = +3.0V$ ;  $0.01\mu F$  across CZ and  $\overline{CZ}$ ; MIXOUT tied to VREF through  $165\Omega$  resistor; TXOUT and  $\overline{TXOUT}$  loaded with  $100\Omega$  differential; LO terminated with  $50\Omega$ ;  $\overline{LO}$  AC grounded; GC open; LIMOUT,  $\overline{LIMOUT}$  open;  $330pF$  at RSSI pin;  $0.1\mu F$  connected from VREF pin to GND;  $P_{RXIN}$ ,  $\overline{RXIN} = -30dBm$  differentially driven (input matched);  $f_{RXIN}$ ,  $\overline{RXIN} = 240MHz$ ; bias voltage at I,  $\overline{I}$ , Q,  $\overline{Q} = 1.4V$ ;  $V_{I,Q} = 500mVp-p$ ;  $f_{I,Q} = 200kHz$ ;  $f_{LO}$ ,  $\overline{LO} = 230MHz$ ;  $P_{LO} = -13dBm$ ;  $T_A = +25^\circ C$ ; unless otherwise noted.)

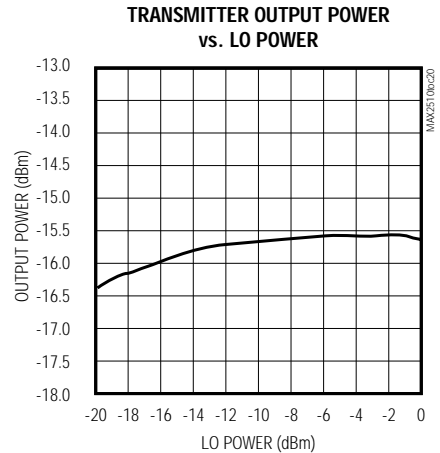
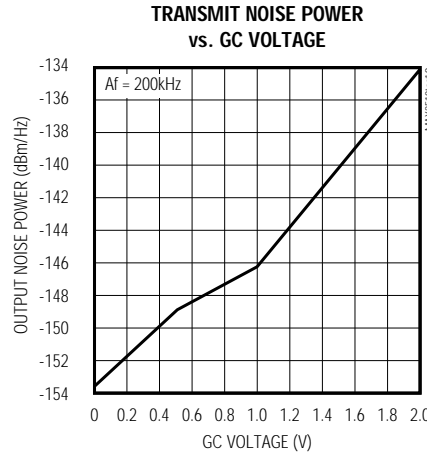
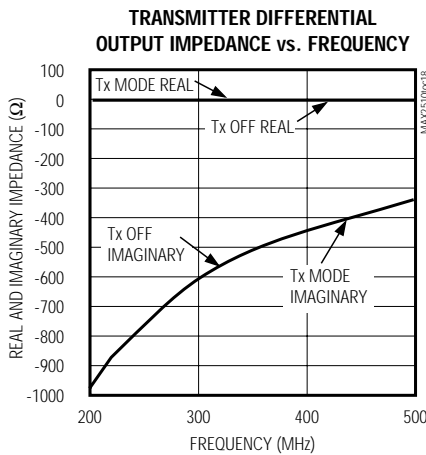
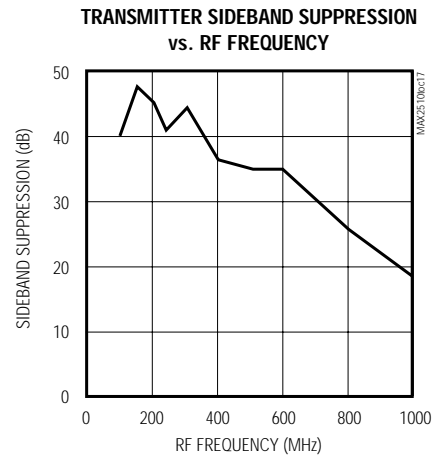
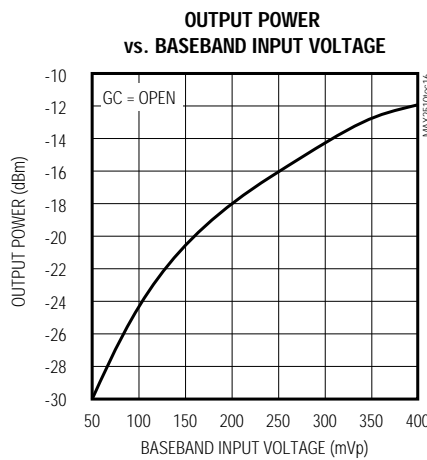
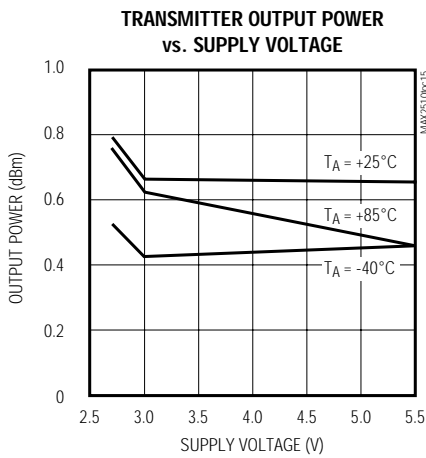

# Low-Voltage IF Transceiver with Limiter/RSSI and Quadrature Modulator

## Pin Description

PIN	NAME	FUNCTION
1	LIMIN	Limiter Input. Connect a 330 $\Omega$ (typical) resistor to VREF for DC bias, as shown in the <i>Typical Operating Circuit</i> .
2, 3	CZ, $\overline{CZ}$	Offset-Correction Capacitor Pins. Connect a 0.01 $\mu$ F capacitor between CZ and $\overline{CZ}$ .
4	RSSI	Received Signal-Strength Indicator Output. The voltage on RSSI is proportional to the signal power at LIMIN. The RSSI output sources current pulses into a 330pF (typical) external capacitor. This output is internally terminated with 11k $\Omega$ , and this RC time constant sets the decay time.
5	GC	Gain-Control Pin. Applying a DC voltage to GC between 0V and 2.0V adjusts the transmitter gain by more than 40dB. GC is internally terminated to 1.35V via an 85k $\Omega$ resistor.
6, 9	LO, $\overline{LO}$	Differential LO Inputs. In a typical application, externally terminate LO with 50 $\Omega$ to ground, then AC couple into LO. AC terminate $\overline{LO}$ directly to ground for single-ended operation, as shown in the <i>Typical Operating Circuit</i> .
7	GND	Local-Oscillator Input Ground. Connect to PC board ground plane with minimal inductance.
8	VCC	Local-Oscillator Input VCC Pin. Bypass directly to local-oscillator input ground (pin 8).
10	GND	Limiter Ground. Connect to PC board ground plane with minimal inductance.
11	TXEN	Transmitter-Enable Pin. When high, TXEN enables the transmitter if RXEN is low. If both TXEN and RXEN are high, the part is in standby mode; if both are low, the part is in shutdown. See the <i>Power Management</i> section for details.
12	RXEN	Receiver Enable Pin. When high, RXEN enables the receiver if TXEN is low. If both RXEN and TXEN are high, the part is in standby mode; if both are low, the part is in shutdown. See the <i>Power Management</i> section for details.
13, 14	$\overline{LIMOUT}$ , LIMOUT	Differential Outputs of the Limiting Amplifier. These outputs are complementary emitter followers capable of driving 250 $\Omega$ single-ended loads to $\pm$ 300mV.
15, 16	I, $\overline{I}$	Baseband In-Phase Inputs. The differential voltage across these inputs forms the quadrature modulator's I-channel input. The signal input level is typically up to 500mVp-p centered around a 1.4V (typical) DC bias level on $\overline{I}$ .
17, 18	$\overline{Q}$ , Q	Baseband Quadrature-Phase Inputs. The differential voltage across these inputs forms the quadrature modulator's Q-channel input. The signal input level is typically up to 500mVp-p, centered around a 1.4V (typical) DC bias level on $\overline{Q}$ .
19, 21	VCC	General-Purpose VCC Pins. Bypass with a 0.047 $\mu$ F low-inductance capacitor to GND.
20	GND	Receiver/Transmitter Ground. Connect to PC board ground plane with minimal inductance.
22, 25	$\overline{RXIN}$ , RXIN	Differential Inputs of the Downconverter Mixer. An impedance-matching network may be required in some applications. See the <i>Applications Information</i> section for details.
23, 24	$\overline{TXOUT}$ , TXOUT	Differential Outputs of the Upconverter. In a typical application, these open-collector outputs are pulled up to VCC with two external inductors and AC coupled to the load. See the <i>Applications Information</i> section for more details, including information on impedance matching these outputs to a load.
26	GND	Receiver Mixer Ground. Connect to PC board ground plane with minimal inductance.
27	MIXOUT	Single-Ended Output of the Downconverter Mixer. This pin is high-impedance and must be biased to the VREF pin through an external terminating resistor whose value depends on the interstage filter characteristics. See the <i>Applications Information</i> section for details.
28	VREF	Reference Voltage Pin. VREF provides an external bias voltage for the MIXOUT and LIMIN pins. Bypass this pin with a 0.1 $\mu$ F capacitor to ground. The VREF voltage is equal to VCC / 2. See the <i>Typical Operating Circuit</i> for more information.



# Low-Voltage IF Transceiver with Limiter/RSSI and Quadrature Modulator

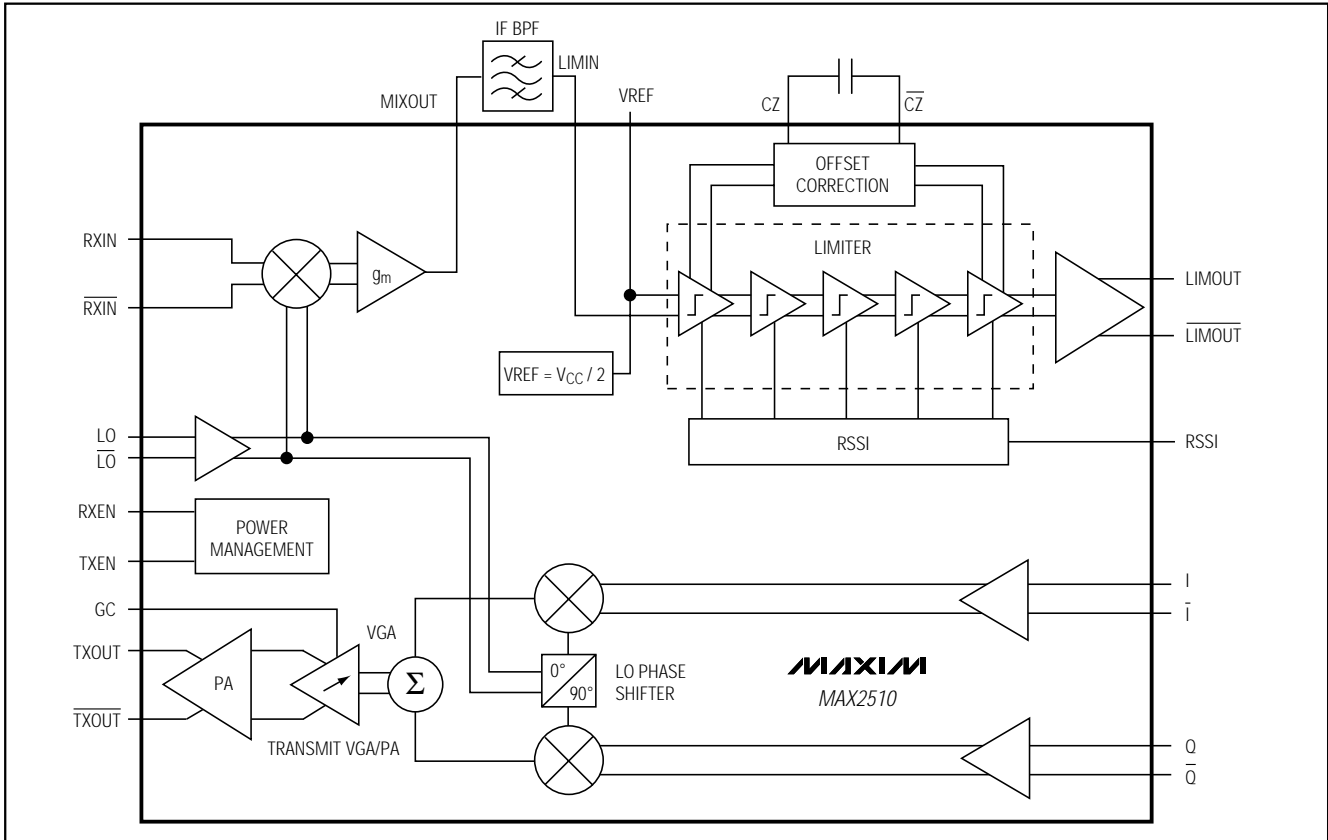

Figure 1. Functional Diagram

## Detailed Description

The following sections describe each of the blocks shown in Figure 1.

### Receiver

The receiver consists of two basic blocks: the down-converter mixer and the limiter/received-signal-strength indicator (RSSI) section.

The receiver inputs are the RXIN and  $\overline{\text{RXIN}}$  pins, which should be AC coupled and may require a matching network as shown in the *Typical Operating Circuit*. To design a matching network for a particular application, consult the RXIN Input Impedance plots in the *Typical Operating Characteristics*, as well as the *Applications Information* sections.

### Downconverter Mixer

The downconverter consists of an a double-balanced mixer and an output buffer. The MIXOUT output, a single-ended current source, can drive a shunt-terminated

330Ω filter (165Ω load) to more than 2Vp-p over the entire supply range, providing excellent dynamic range. The local oscillator (LO) input is buffered and drives the mixer.

### Limiter

The signal passes through an external IF bandpass filter into the limiter input (LIMIN). LIMIN is a single-ended input that is biased at the VREF pin voltage. The open-circuit input impedance is typically greater than 10kΩ to VREF. For proper operation, LIMIN must be tied to VREF through the filter-terminating impedance (which should be less than 1kΩ). The limiter provides a constant output level, which is largely independent of the limiter input signal level over a 90dB input range. The low-impedance limiter outputs provide 600mVp-p single-ended swing (1.2Vp-p differential swing) and can drive CMOS inputs directly.

# Low-Voltage IF Transceiver with Limiter/RSSI and Quadrature Modulator

## Received Signal-Strength Indicator

The RSSI output provides a linear indication of the received power level on the LIMIN input. The RSSI monotonic dynamic range exceeds 90dB while providing better than 80dB linear range. The RSSI output pulses current into a 330pF (typical) external filter capacitor. The output is internally terminated to ground with 11k $\Omega$ , and this R-C time constant sets the decay time. The rise time is limited by the RSSI pin's output drive current. The rise time is typically less than 100ns with no capacitor connected. Larger capacitor values slow the rise time.

## Transmitter

The I,  $\bar{I}$  and Q,  $\bar{Q}$  baseband signals are input to a pair of double-balanced mixers, which are driven from a quadrature LO source. The quadrature LO is generated on-chip from the oscillator input present at the LO and  $\bar{LO}$  pins. The two mixers' outputs are summed. With quadrature baseband inputs at the I,  $\bar{I}$  and Q,  $\bar{Q}$  pins, the unwanted sideband is largely canceled. The resulting signal from the mixers is fed through a variable-gain amplifier (VGA) with more than 40dB of gain-adjust range.

The VGA output is connected to a driver amplifier with an output 1dB compression point of +2dBm. The output power can be adjusted from approximately +2dBm to -40dBm by controlling the GC pin. The resulting signal appears as a differential output on the TXOUT and  $\bar{TXOUT}$  pins.

TXOUT and  $\bar{TXOUT}$  are open-collector outputs and need external pull-up inductors to  $V_{CC}$  for proper operation, as well as a DC block so the load does not affect DC biasing. A shunt resistor across TXOUT and  $\bar{TXOUT}$  (100 $\Omega$  typical) can be used to back terminate an external filter, as shown in the *Typical Operating Circuit*. Alternatively, a single-ended load can be connected to TXOUT, as long as  $\bar{TXOUT}$  is tied directly to  $V_{CC}$ . Refer to the *Applications Information* section for details.

## Local-Oscillator Inputs

The MAX2510 requires an external LO source for the mixers. LO and  $\bar{LO}$  are high-impedance inputs (>1k $\Omega$ ). The external LO signal is buffered internally and fed to both the receive mixer and the LO phase shifter used for the transmit mixers.

In a typical application, externally terminate the LO source with a 50 $\Omega$  resistor and then AC couple into LO. Typically, the LO power range should be -13dBm to

0dBm (into 50 $\Omega$ ). Connect a bypass capacitor from  $\bar{LO}$  to ground. Alternatively, a differential LO source (externally terminated) can drive LO and  $\bar{LO}$  through series coupling capacitors.

## Power Management

To provide advanced system power management, the MAX2510 features four operating modes that are selected via the RXEN and TXEN pins, according to Table 1 (supply currents assume GC = 0.5V).

In shutdown mode, all part functions are off. Standby mode allows fastest enabling of either transmit or receive mode by keeping the VREF generator active. This avoids delays in stabilizing the limiter input circuitry and the offset correction loop. Transmit mode enables the LO buffer, LO phase shifter, upconverter mixer, transmit VGA, and transmit output driver amplifier. Receive mode enables the LO buffer, downconverter mixer, limiting amplifier, and RSSI functions.

**Table 1. Power-Supply Mode Selection**

RXEN STATE	TXEN STATE	MODE	TYPICAL SUPPLY CURRENT (A)
Low	Low	Shutdown	0.2 $\mu$
Low	High	Transmit	17m
High	Low	Receive	14m
High	High	Standby	0.5m

## Applications Information

### RX Input Matching

The RXIN,  $\bar{RXIN}$  port typically needs an impedance matching network for proper connection to external circuitry, such as a filter. See the *Typical Operating Circuit* for an example circuit topology. Note that the receiver input can be driven either single-ended or differentially.

The component values used in the matching network depend on the desired operating frequency as well as on filter impedance. The following table indicates the RXIN,  $\bar{RXIN}$  single-ended input impedance (that is, the impedance looking into either RXIN or  $\bar{RXIN}$ ). The information in Table 2 is also plotted in the *Typical Operating Characteristics*.

# Low-Voltage IF Transceiver with Limiter/RSSI and Quadrature Modulator

**Table 2. RXIN or  $\overline{\text{RXIN}}$  Input Impedance**

FREQUENCY (MHz)	SERIES IMPEDANCE ( $\Omega$ )
100	275 - j203
200	149 - j184
300	94 - j143
400	64 - j109
500	53 - j87

### Receive IF Filter

The interstage filter, located between the MIXOUT pin and the LIMIN pin, is typically a three-terminal, 330 $\Omega$ , 10.7MHz bandpass filter. This filter prevents the limiter from acting on any undesired signals that are present at the mixer's output, such as LO feedthrough, out-of-band channel leakage, and spurious mixer products. The filter connections are also set up to feed DC bias from VREF into LIMIN and MIXOUT through two 330 $\Omega$  filter-termination resistors. (See the *Typical Operating Circuit* for more information).

### Transmit Output Matching

The transmit outputs, TXOUT and  $\overline{\text{TXOUT}}$ , are open-collector outputs and therefore present a high impedance.

For differential drive, TXOUT and  $\overline{\text{TXOUT}}$  are connected to VCC via chokes, and each side is AC coupled to the load. A terminating resistor between TXOUT and  $\overline{\text{TXOUT}}$  sets the output impedance. This resistor provides a stable means of matching to the load.

TXOUT and  $\overline{\text{TXOUT}}$  are voltage-swing limited, and therefore cannot drive the specified maximum power across more than 150 $\Omega$  load impedance. This load impedance typically consists of a shunt-terminating resistor in parallel with a filter load impedance. To drive higher output load impedances, the gain must be reduced (via the GC pin) to avoid saturating the TX output stage.

For single-ended applications, connect the unused TX output output pin directly to VCC.

### 400MHz ISM Applications

The MAX2510 can be used as a front-end IC in applications where the RF carrier frequency is in the 400MHz ISM band. In this case, Maxim recommends preceding the MAX2510 receiver section with a low-

noise amplifier (LNA) that can operate over the same supply voltage range. The MAX2630–MAX2633 family of amplifiers meets this requirement. In many applications, the MAX2510's transmit output power is sufficient to eliminate the need for an external power amplifier.

### Layout Issues

A well-designed PC board is an essential part of an RF circuit. Use the MAX2510 evaluation kit and the recommendations below as guides to generate your own layout.

### Power-Supply Layout

A star topology, which has a heavily decoupled central VCC node, is the ideal power-supply layout for minimizing coupling between different sections of the chip. The VCC traces branch out from this node, each going to one VCC connection in the MAX2510 typical operating circuit. At the end of each of these traces is a bypass capacitor that presents low impedance at the RF frequency of interest. This method provides local decoupling at each VCC pin. At high frequencies, any signal leaking out of a supply pin sees a relatively high impedance (formed by the VCC trace impedance) to the central VCC node, and an even higher impedance to any other supply pin, minimizing VCC supply-pin coupling.

A single ground plane suffices. Where possible, multiple parallel vias aid in reducing inductance to the ground plane.

Place the VREF decoupling capacitor (0.1 $\mu$ F typical) as close to the MAX2510 as possible for best interstage filter performance. For best results, use a high-quality, low-ESR capacitor.

Matching/biasing networks around the receive and transmit pins should be symmetric and as close to the chip as possible. A cutout in the ground plane under the matching network components can be used to reduce parasitic capacitance.

Decouple pins 19 and 21 (VCC) directly to pin 20 (Rx, Tx ground), which should be directly connected to the ground plane. Similarly, decouple pin 8 directly to pin 7. Refer to the *Pin Description* table for more information.

# Low-Voltage IF Transceiver with Limiter/RSSI and Quadrature Modulator

## Typical Operating Circuit

