

**±15kV ESD Protected, 20Mbps, 5V, Low Power, RS-485/RS-422 Transceiver**

The Intersil ISL4485E is a high speed, BiCMOS 5V powered, single transceiver that meets both the RS-485 and RS-422 standards for balanced communication. Each driver output/receiver input is protected against ±15kV ESD strikes, without latch-up. Unlike competitive devices, this Intersil device is specified for 10% tolerance supplies (4.5V to 5.5V).

The excellent differential output voltage coupled with high drive-current output stages allow 20Mbps operation over twisted pair networks up to 450 feet in length. The 25kΩ receiver input resistance presents a “single unit load” to the RS-485 bus, allowing up to 32 transceivers on the network.

Receiver (Rx) inputs feature a “fail-safe if open” design, which ensures a logic high Rx output if Rx inputs are floating.

Driver (Tx) outputs are short circuit protected, even for voltages exceeding the power supply voltage. Additionally, on-chip thermal shutdown circuitry disables the Tx outputs to prevent damage if power dissipation becomes excessive.

The half duplex configuration multiplexes the Rx inputs and Tx outputs to allow transceivers with Rx and Tx disable functions in 8 lead packages.

**Ordering Information**

PART NO. (BRAND)	TEMP. RANGE (°C)	PACKAGE	PKG. DWG. #
ISL4485EIB (4485EIB)	-40 to 85	8 Ld SOIC	M8.15
ISL4485EIBZ (4485EIBZ) (See Note)	-40 to 85	8 Ld SOIC (Pb-free)	M8.15
ISL4485EIB-T (4485EIB)	-40 to 85	8 Ld SOIC Tape & Reel	M8.15
ISL4485EIBZ-T (4485EIBZ) (See Note)	-40 to 85	8 Ld SOIC Tape & Reel (Pb-free)	M8.15

NOTE: Intersil Pb-free products employ special Pb-free material sets; molding compounds/die attach materials and 100% matte tin plate termination finish, which are RoHS compliant and compatible with both SnPb and Pb-free soldering operations. Intersil Pb-free products are MSL classified at Pb-free peak reflow temperatures that meet or exceed the Pb-free requirements of IPC/JEDEC J STD-020.

**Features**

- Pb-Free Available (RoHS Compliant)
- High Data Rates . . . . . up to 20Mbps
- RS-485 I/O Pin ESD Protection . . . . . ±15kV HBM - Class 3 ESD Level on all Other Pins . . . . . >7kV HBM
- Operates from a Single +5V Supply (10% Tolerance)
- 1 Unit Load Allows up to 32 Devices on the Bus
- Low Quiescent Current . . . . . 700µA
- -7V to +12V Common Mode Input Voltage Range
- Three State Rx and Tx Outputs
- 30ns Propagation Delays, 2ns Skew
- Current Limiting and Thermal Shutdown for driver Overload Protection

**Applications**

- SCSI “Fast 20” Drivers and Receivers
- Data Loggers
- Security Networks
- Building Environmental Control Systems
- Industrial/Process Control Networks
- Level Translators

**Pinout**

ISL4485E (SOIC)  
TOP VIEW

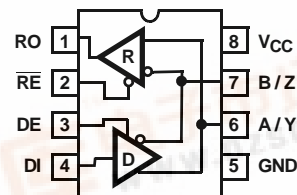

## ISL4485E

### Truth Tables

TRANSMITTING				
INPUTS			OUTPUTS	
$\overline{RE}$	DE	DI	B/Z	A/Y
X	1	1	0	1
X	1	0	1	0
X	0	X	High-Z	High-Z

RECEIVING			
INPUTS			OUTPUT
$\overline{RE}$	DE	A-B	RO
0	0	$\geq +0.2V$	1
0	0	$\leq -0.2V$	0
0	0	Inputs Open	1
1	X	X	High-Z

### Pin Descriptions

PIN	FUNCTION
RO	Receiver output: If $A > B$ by at least 0.2V, RO is high; If $A < B$ by 0.2V or more, RO is low; RO = High if A and B are unconnected (floating).
$\overline{RE}$	Receiver output enable. RO is enabled when $\overline{RE}$ is low; RO is high impedance when $\overline{RE}$ is high.
DE	Driver output enable. The driver outputs, Y and Z, are enabled by bringing DE high. They are high impedance when DE is low.
DI	Driver input. A low on DI forces output Y low and output Z high. Similarly, a high on DI forces output Y high and output Z low.
GND	Ground connection.
A/Y	$\pm 15kV$ HBM ESD Protected, noninverting receiver input and noninverting driver output. Pin is an input (A) if DE = 0; pin is an output (Y) if DE = 1.
B/Z	$\pm 15kV$ HBM ESD Protected, inverting receiver input and inverting driver output. Pin is an input (B) if DE = 0; pin is an output (Z) if DE = 1.
VCC	System power supply input (4.5V to 5.5V).

### Typical Operating Circuit

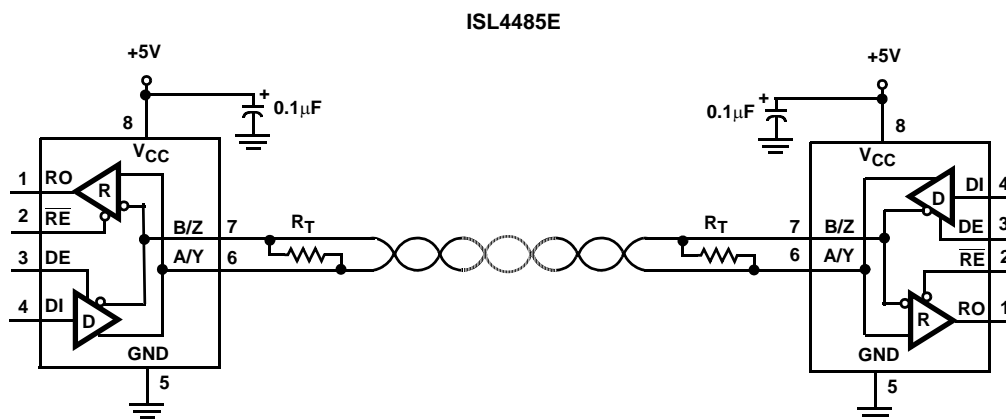

# ISL4485E

## Absolute Maximum Ratings

V <sub>CC</sub> to Ground	7V
Input Voltages	
DI, DE, $\overline{RE}$	-0.5V to (V <sub>CC</sub> + 0.5V)
Input / Output Voltages	
A / Y, B / Z	-8V to +12.5V
RO	-0.5V to (V <sub>CC</sub> + 0.5V)
Short Circuit Duration	
Y, Z	Continuous
ESD Rating	See Specification Table

## Thermal Information

Thermal Resistance (Typical, Note 1)	$\theta_{JA}$ (°C/W)
8 Ld SOIC Package	170
Maximum Junction Temperature (Plastic Package)	150°C
Maximum Storage Temperature Range	-65°C to 150°C
Maximum Lead Temperature (Soldering 10s) (Lead Tips Only)	300°C

## Operating Conditions

Temperature Range	
ISL4485EIB	-40°C to 85°C

**CAUTION:** Stresses above those listed in "Absolute Maximum Ratings" may cause permanent damage to the device. This is a stress only rating and operation of the device at these or any other conditions above those indicated in the operational sections of this specification is not implied.

### NOTE:

- $\theta_{JA}$  is measured with the component mounted on a low effective thermal conductivity test board in free air. See Tech Brief TB379 for details.

**Electrical Specifications** Test Conditions: V<sub>CC</sub> = 4.5V to 5.5V; Unless Otherwise Specified.  
Typicals are at V<sub>CC</sub> = 5V, T<sub>A</sub> = 25°C, Note 2

PARAMETER	SYMBOL	TEST CONDITIONS	TEMP (°C)	MIN	TYP	MAX	UNITS	
<b>DC CHARACTERISTICS</b>								
Driver Differential V <sub>OUT</sub> (no load)	V <sub>OD1</sub>		Full	-	-	V <sub>CC</sub>	V	
Driver Differential V <sub>OUT</sub> (with load)	V <sub>OD2</sub>	R = 50Ω (RS-422), (Figure 1)	Full	2	3	-	V	
		R = 27Ω (RS-485), (Figure 1)	Full	1.5	2.3	5	V	
Change in Magnitude of Driver Differential V <sub>OUT</sub> for Complementary Output States	$\Delta V_{OD}$	R = 27Ω or 50Ω, (Figure 1)	Full	-	0.01	0.2	V	
Driver Common-Mode V <sub>OUT</sub>	V <sub>OC</sub>	R = 27Ω or 50Ω, (Figure 1)	Full	-	-	3	V	
Change in Magnitude of Driver Common-Mode V <sub>OUT</sub> for Complementary Output States	$\Delta V_{OC}$	R = 27Ω or 50Ω, (Figure 1)	Full	-	0.01	0.2	V	
Logic Input High Voltage	V <sub>IH</sub>	DE, DI, $\overline{RE}$	Full	2	-	-	V	
Logic Input Low Voltage	V <sub>IL</sub>	DE, DI, $\overline{RE}$	Full	-	-	0.8	V	
Logic Input Current	I <sub>IN1</sub>	DE, DI, $\overline{RE}$	Full	-25	-	25	μA	
Input Current (A, B), (Note 5)	I <sub>IN2</sub>	DE = 0V, V <sub>CC</sub> = 0V or 4.5 to 5.5V	V <sub>IN</sub> = 12V	Full	-	-	1	mA
			V <sub>IN</sub> = -7V	Full	-	-	-0.8	mA
Receiver Differential Threshold Voltage	V <sub>TH</sub>	-7V ≤ V <sub>CM</sub> ≤ 12V	Full	-0.2	-	0.2	V	
Receiver Input Hysteresis	$\Delta V_{TH}$	V <sub>CM</sub> = 0V	25	-	70	-	mV	
Receiver Output High Voltage	V <sub>OH</sub>	I <sub>O</sub> = -4mA, V <sub>ID</sub> = 200mV	Full	3.5	4	-	V	
Receiver Output Low Voltage	V <sub>OL</sub>	I <sub>O</sub> = -4mA, V <sub>ID</sub> = 200mV	Full	-	0.1	0.4	V	
Three-State (high impedance) Receiver Output Current	I <sub>OZR</sub>	0.4V ≤ V <sub>O</sub> ≤ 2.4V	Full	-	-	±1	μA	
Receiver Input Resistance	R <sub>IN</sub>	-7V ≤ V <sub>CM</sub> ≤ 12V	Full	12	25	-	kΩ	
No-Load Supply Current, (Note 3)	I <sub>CC</sub>	DI, $\overline{RE}$ = 0V or V <sub>CC</sub>	DE = V <sub>CC</sub>	Full	-	700	900	μA
			DE = 0V	Full	-	500	565	μA
Driver Short-Circuit Current, V <sub>O</sub> = High or Low	I <sub>OSD1</sub>	DE = V <sub>CC</sub> , -7V ≤ V <sub>Y</sub> or V <sub>Z</sub> ≤ 12V, (Note 4)	Full	35	-	250	mA	
Receiver Short-Circuit Current	I <sub>OSR</sub>	0V ≤ V <sub>O</sub> ≤ V <sub>CC</sub>	Full	7	-	85	mA	

## ISL4485E

**Electrical Specifications** Test Conditions:  $V_{CC} = 4.5V$  to  $5.5V$ ; Unless Otherwise Specified.  
Typicals are at  $V_{CC} = 5V$ ,  $T_A = 25^{\circ}C$ , Note 2 (Continued)

PARAMETER	SYMBOL	TEST CONDITIONS	TEMP (°C)	MIN	TYP	MAX	UNITS
<b>SWITCHING CHARACTERISTICS</b>							
Driver Input to Output Delay	$t_{PLH}, t_{PHL}$	$R_{DIFF} = 54\Omega, C_L = 100pF$ , (Figure 2)	Full	15	30	50	ns
Driver Output Skew	$t_{SKEW}$	$R_{DIFF} = 54\Omega, C_L = 100pF$ , (Figure 2)	Full	-	1.3	5	ns
Driver Differential Rise or Fall Time	$t_R, t_F$	$R_{DIFF} = 54\Omega, C_L = 100pF$ , (Figure 2)	Full	3	11	25	ns
Driver Enable to Output High	$t_{ZH}$	$C_L = 100pF, SW = GND$ , (Figure 3)	Full	-	17	30	ns
Driver Enable to Output Low	$t_{ZL}$	$C_L = 100pF, SW = V_{CC}$ , (Figure 3)	Full	-	14	30	ns
Driver Disable from Output High	$t_{HZ}$	$C_L = 15pF, SW = GND$ , (Figure 3)	Full	-	19	30	ns
Driver Disable from Output Low	$t_{LZ}$	$C_L = 15pF, SW = V_{CC}$ , (Figure 3)	Full	-	13	30	ns
Driver Maximum Data Rate	$f_{MAXD}$	$V_{OD} \geq 1.5V$ , (Figure 4, Note 6)	Full	20	-	-	Mbps
Receiver Input to Output Delay	$t_{PLH}, t_{PHL}$	Figure 5	Full	20	40	70	ns
Receiver Skew   $t_{PLH} - t_{PHL}$	$t_{SKD}$	Figure 5	Full	-	3	10	ns
Receiver Enable to Output High	$t_{ZH}$	$C_L = 15pF, SW = GND$ , (Figure 6)	Full	-	9	25	ns
Receiver Enable to Output Low	$t_{ZL}$	$C_L = 15pF, SW = V_{CC}$ , (Figure 6)	Full	-	9	25	ns
Receiver Disable from Output High	$t_{HZ}$	$C_L = 15pF, SW = GND$ , (Figure 6)	Full	-	9	25	ns
Receiver Disable from Output Low	$t_{LZ}$	$C_L = 15pF, SW = V_{CC}$ , (Figure 6)	Full	-	9	25	ns
Receiver Maximum Data Rate	$f_{MAXR}$	$C_L = 15pF, V_{ID} \geq 1.5V$ (Note 6)	Full	20	-	-	Mbps
<b>ESD PERFORMANCE</b>							
RS-485 Pins (A/Y, B/Z)		Human Body Model	25	-	$\pm 15$	-	kV
All Other Pins			25	-	$>\pm 7$	-	kV

**NOTE:**

2. All currents into device pins are positive; all currents out of device pins are negative. All voltages are referenced to device ground unless otherwise specified.
3. Supply current specification is valid for loaded drivers when  $DE = 0V$ .
4. Applies to peak current. See "Typical Performance Curves" for more information.
5. Devices meeting these limits are denoted as "single unit load (1 UL)" transceivers. The RS-485 standard allows up to 32 Unit Loads on the bus.
6. Guaranteed by characterization, but not tested.

### Test Circuits and Waveforms

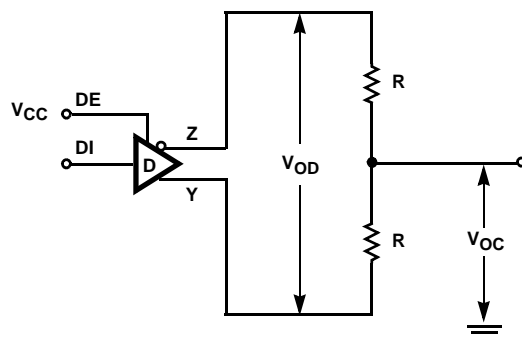

FIGURE 1. DRIVER  $V_{OD}$  AND  $V_{OC}$

Test Circuits and Waveforms (Continued)

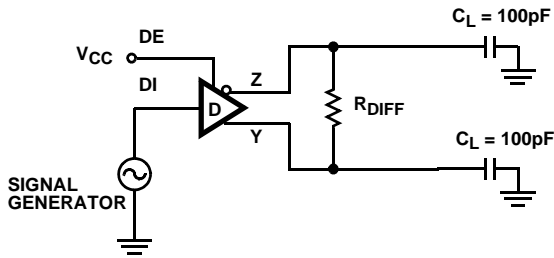

FIGURE 2A. TEST CIRCUIT

FIGURE 2. DRIVER PROPAGATION DELAY AND DIFFERENTIAL TRANSITION TIMES

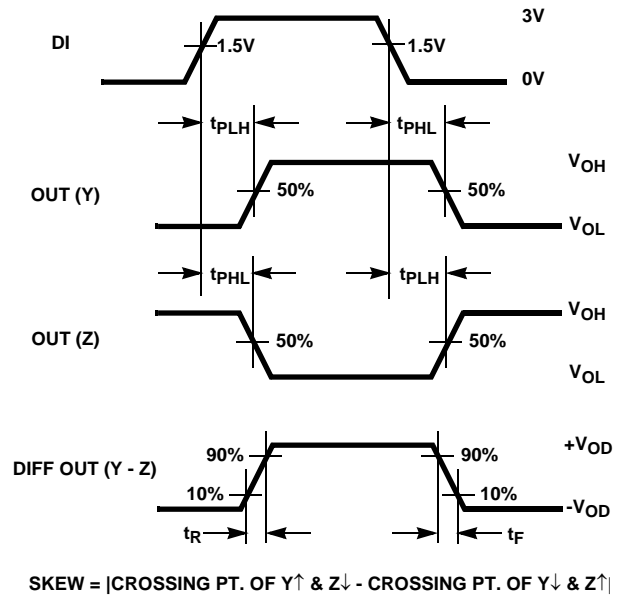

FIGURE 2B. MEASUREMENT POINTS

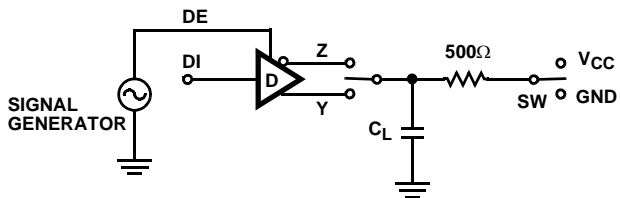

FIGURE 3A. TEST CIRCUIT

FIGURE 3. DRIVER ENABLE AND DISABLE TIMES

PARAMETER	OUTPUT	$\overline{RE}$	DI	SW	$C_L$ (pF)
$t_{HZ}$	Y/Z	X	1/0	GND	15
$t_{LZ}$	Y/Z	X	0/1	$V_{CC}$	15
$t_{ZH}$	Y/Z	X	1/0	GND	100
$t_{ZL}$	Y/Z	X	0/1	$V_{CC}$	100

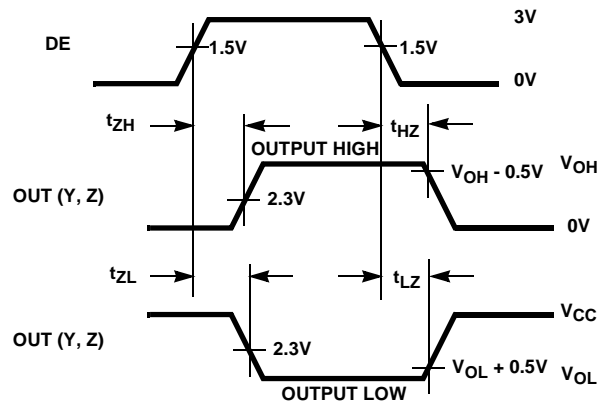

FIGURE 3B. MEASUREMENT POINTS

Test Circuits and Waveforms (Continued)

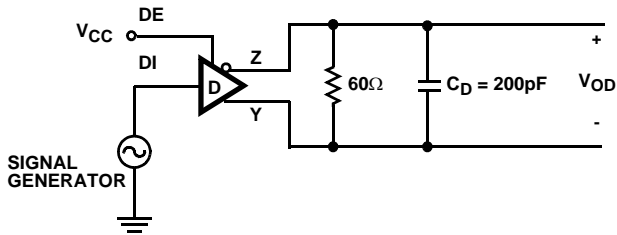

FIGURE 4A. TEST CIRCUIT

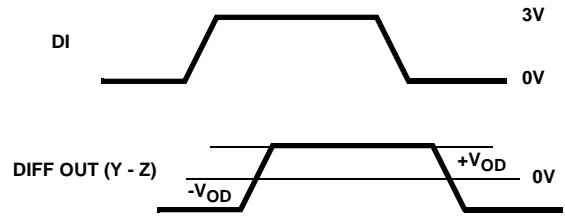

FIGURE 4B. MEASUREMENT POINTS

FIGURE 4. DRIVER DATA RATE

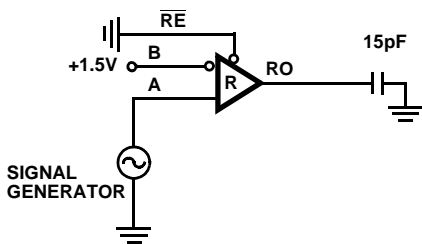

FIGURE 5A. TEST CIRCUIT

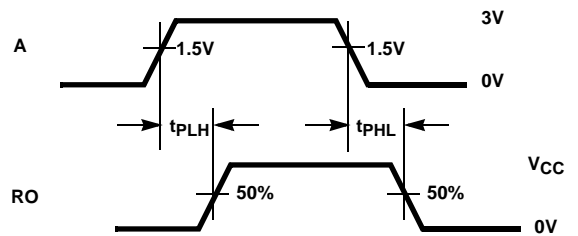

FIGURE 5B. MEASUREMENT POINTS

FIGURE 5. RECEIVER PROPAGATION DELAY

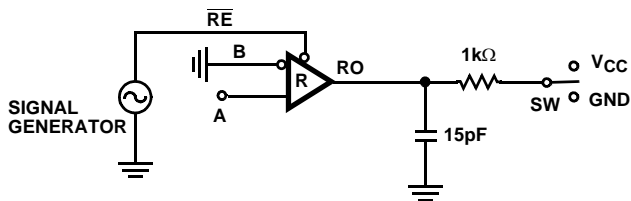

FIGURE 6A. TEST CIRCUIT

PARAMETER	DE	A	SW
$t_{HZ}$	0	+1.5V	GND
$t_{LZ}$	0	-1.5V	$V_{CC}$
$t_{ZH}$	0	+1.5V	GND
$t_{ZL}$	0	-1.5V	$V_{CC}$

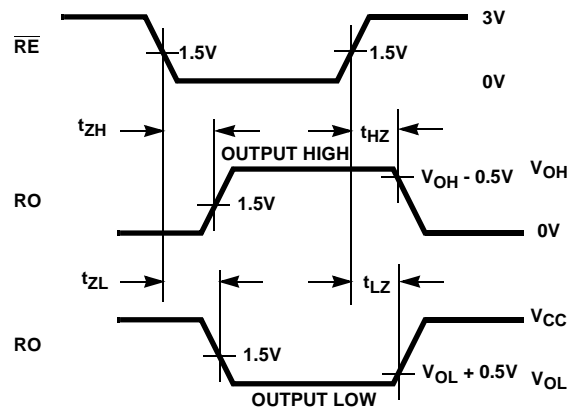

FIGURE 6B. MEASUREMENT POINTS

FIGURE 6. RECEIVER ENABLE AND DISABLE TIMES

### Application Information

RS-485 and RS-422 are differential (balanced) data transmission standards for use in long haul or noisy environments. RS-422 is a subset of RS-485, so RS-485 transceivers are also RS-422 compliant. RS-422 is a point-to-multipoint (multidrop) standard, which allows only one driver and up to 10 (assuming one unit load devices) receivers on each bus. RS-485 is a true multipoint standard, which allows up to 32 one unit load devices (any combination of drivers and receivers) on each bus. To allow for multipoint operation, the RS-485 spec requires that drivers must handle bus contention without sustaining any damage.

Another important advantage of RS-485 is the extended common mode range (CMR), which specifies that the driver outputs and receiver inputs withstand signals that range from +12V to -7V. RS-422 and RS-485 are intended for runs as long as 4000', so the wide CMR is necessary to handle ground potential differences, as well as voltages induced in the cable by external fields.

### Receiver Features

The ISL4485E utilizes a differential input receiver for maximum noise immunity and common mode rejection. Input sensitivity is  $\pm 200\text{mV}$ , as required by the RS-422 and RS-485 specifications.

Receiver input impedance surpasses the RS-422 spec of  $4\text{k}\Omega$ , and meets the RS-485 "Unit Load" requirement of  $12\text{k}\Omega$  minimum.

Receiver inputs function with common mode voltages as great as  $\pm 7\text{V}$  outside the power supplies (i.e., +12V and -7V), making them ideal for long networks where induced voltages are a realistic concern.

The receiver includes a "fail-safe if open" function that guarantees a high level receiver output if the receiver inputs are unconnected (floating). The output is three-statable via the active low  $\overline{\text{RE}}$  input, and the receiver easily meets the 20Mbps data rate.

### Driver Features

The RS-485/422 driver is a differential output device that delivers at least 1.5V across a  $54\Omega$  load (RS-485), and at least 2V across a  $100\Omega$  load (RS-422). The ISL4485E driver features low propagation delay skew to maximize bit width, and to minimize EMI, and the outputs are three-statable via the active high DE input.

Outputs of ISL4485E drivers are not slew rate limited, so faster output transition times allow data rates up to 20Mbps.

### Data Rate, Cables, and Terminations

Twisted pair is the cable of choice for RS-485/422 networks. Twisted pair cables tend to pick up noise and other electromagnetically induced voltages as common mode

signals, which are effectively rejected by the differential receivers in these ICs.

RS-485/422 are intended for network lengths up to 4000', but the maximum transmission length decreases as the data rate increases. According to guidelines in the RS-422 specification, a 20Mbps network should be limited to less than 50' of 24 AWG twisted pair. Nevertheless, the ISL4485E's large differential voltage swing, fast transition times, and high drive-current output stages allow operation at 20Mbps in RS-485/422 networks as long as 450'. Figure 7 details ISL4485E operation at 20Mbps driving 300' of CAT 5 cable terminated in  $120\Omega$  at the driver and the receiver (i.e., double terminated). The acceptance criteria for this test was the ability of the driver to deliver a 1.5V differential signal to the receiver at the end of the cable (i.e.,  $|A-B| \geq 1.5\text{V}$ ). If a more liberal acceptance criteria is used, the distance can be further extended. For example, Figure 8 illustrates the performance in the same configuration, but with a cable length of 450', and an acceptance criteria of no more than 6dB attenuation across the cable (i.e.,  $|A-B| = |Y-Z|/2$ ).

Driver differential output voltage decreases with increasing differential load capacitance, so maintaining a 1.5V differential output requires a data rate reduction, as shown in Figure 9.

To minimize reflections, proper termination is imperative when using this 20Mbps device. In point-to-point, or point-to-multipoint (single driver on bus) networks, the main cable should be terminated in its characteristic impedance (typically  $120\Omega$ ) at the end farthest from the driver. In multi-receiver applications, stubs connecting receivers to the main cable should be kept as short as possible (preferably less than 12 inches). Multipoint (multi-driver) systems require that the main cable be terminated in its characteristic impedance at both ends. Again, stubs connecting a transceiver to the main cable should be kept as short as possible.

### Built-In Driver Overload Protection

As stated previously, the RS-485 spec requires that drivers survive worst case bus contentions undamaged. The ISL4485E device meets this requirement via driver output short circuit current limits, and on-chip thermal shutdown circuitry.

The driver output stages incorporate short circuit current limiting circuitry which ensures that the output current never exceeds the RS-485 spec, even at the common mode voltage range extremes. Additionally, these devices utilize a foldback circuit which reduces the short circuit current, and thus the power dissipation, whenever the contending voltage exceeds either supply.

In the event of a major short circuit condition, this device also includes a thermal shutdown feature that disables the drivers whenever the die temperature becomes excessive. This eliminates the power dissipation, allowing the die to cool. The drivers automatically reenables after the die

## ISL4485E

temperature drops about 15 degrees. If the contention persists, the thermal shutdown / reenable cycle repeats until the fault is cleared. Receivers stay operational during thermal shutdown.

### ESD Protection

All pins on these interface devices include class 3 Human Body Model (HBM) ESD protection structures, but the RS-485 pins (driver outputs and receiver inputs) incorporate advanced structures allowing them to survive ESD events in excess of  $\pm 15\text{kV}$  HBM. The RS-485 pins are particularly vulnerable to ESD damage because they typically connect to an exposed port on the exterior of the finished product. Simply touching the port pins, or connecting a cable, can cause an ESD event that might destroy unprotected ICs. These new ESD structures protect the device whether or not it is powered up, protect without allowing any latchup

mechanism to activate, and without degrading the RS-485 common mode range of  $-7\text{V}$  to  $+12\text{V}$ . This built-in ESD protection eliminates the need for board level protection structures (e.g., transient suppression diodes), and the associated, undesirable capacitive load they present.

### Human Body Model Testing

As the name implies, this test method emulates the ESD event delivered to an IC during human handling. The tester delivers the charge stored on a  $100\text{pF}$  capacitor through a  $1.5\text{k}\Omega$  current limiting resistor into the pin under test. The HBM method determines an ICs ability to withstand the ESD events typically present during handling and manufacturing.

The RS-485 pin survivability on this high ESD device has been characterized to be in excess of  $\pm 15\text{kV}$ , for discharges to GND.

### Typical Performance Curves $V_{CC} = 5\text{V}$ , $T_A = 25^\circ\text{C}$ ; Unless Otherwise Specified

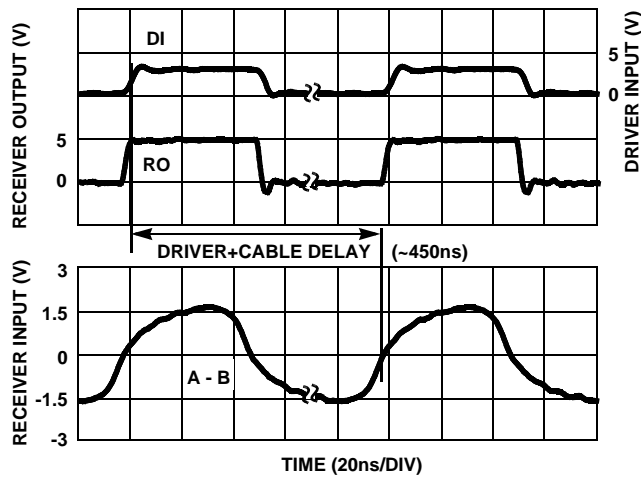

FIGURE 7. DRIVER AND RECEIVER WAVEFORMS DRIVING 300 FEET OF CABLE (DOUBLE TERMINATED)

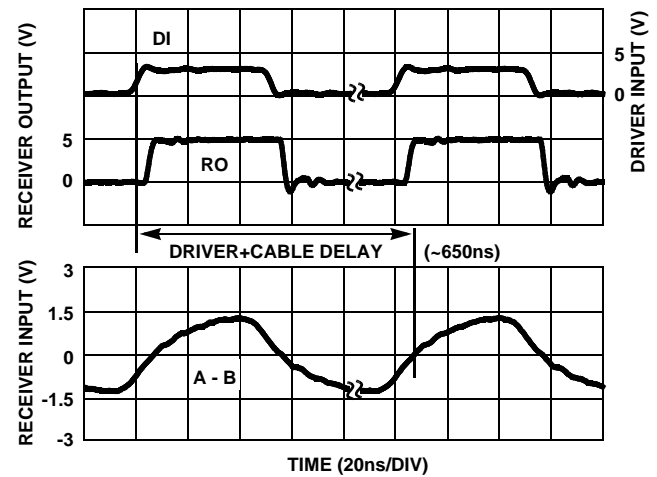

FIGURE 8. DRIVER AND RECEIVER WAVEFORMS DRIVING 450 FEET OF CABLE (DOUBLE TERMINATED)

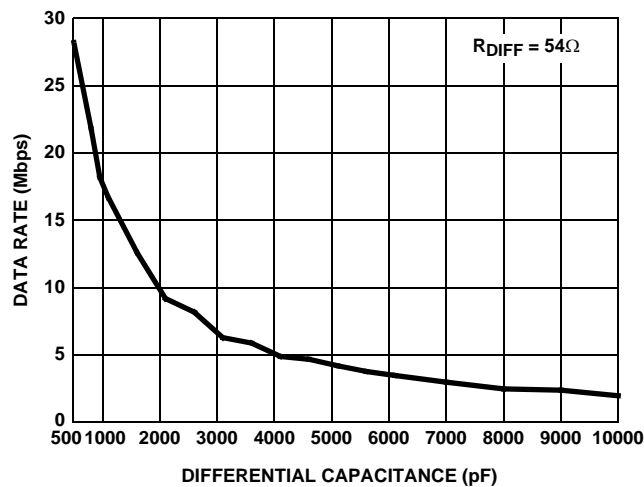

FIGURE 9. DATA RATE vs DIFFERENTIAL CAPACITANCE

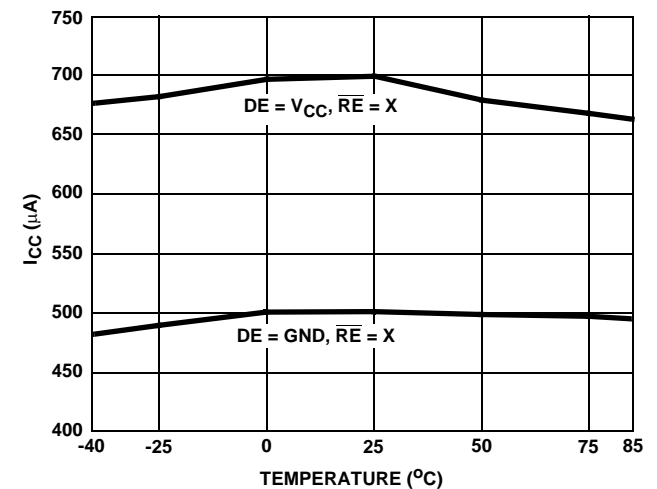

FIGURE 10. SUPPLY CURRENT vs TEMPERATURE



# ISL4485E

## Typical Performance Curves $V_{CC} = 5V, T_A = 25^\circ C$ ; Unless Otherwise Specified (Continued)

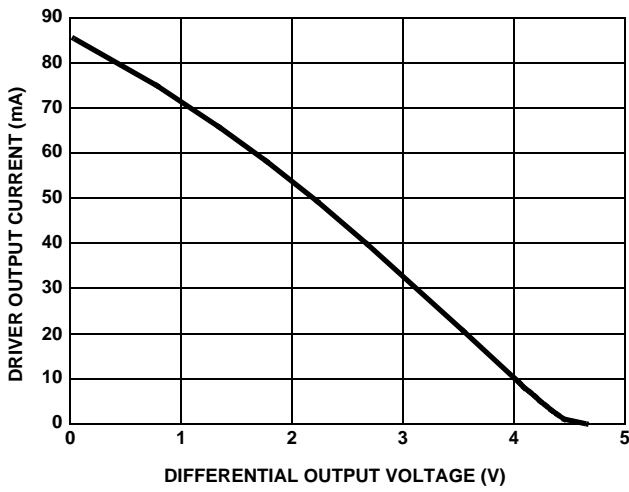

FIGURE 11. DRIVER OUTPUT CURRENT vs DIFFERENTIAL OUTPUT VOLTAGE

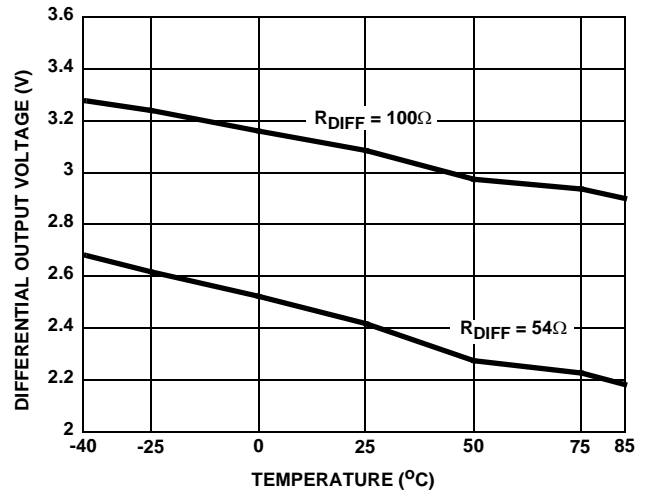

FIGURE 12. DRIVER DIFFERENTIAL OUTPUT VOLTAGE vs TEMPERATURE

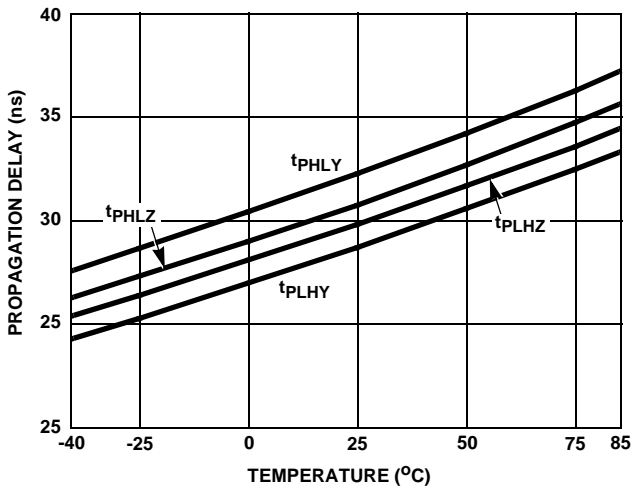

FIGURE 13. DRIVER PROPAGATION DELAY vs TEMPERATURE

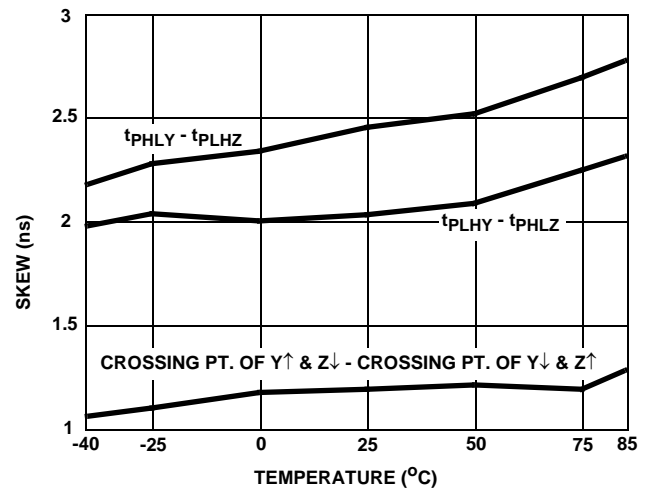

FIGURE 14. DRIVER SKEW vs TEMPERATURE

# ISL4485E

## Typical Performance Curves $V_{CC} = 5V$ , $T_A = 25^\circ C$ ; Unless Otherwise Specified (Continued)

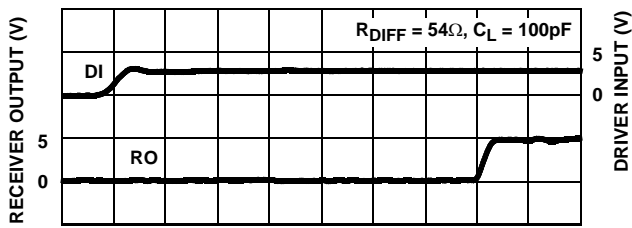

FIGURE 15. DRIVER AND RECEIVER WAVEFORMS, LOW TO HIGH

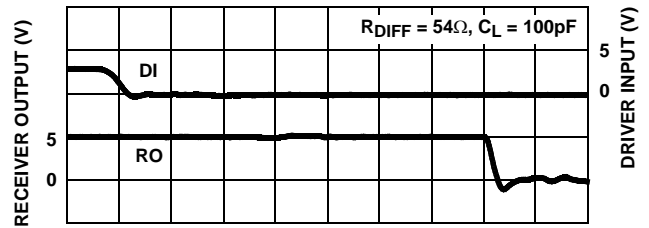

FIGURE 16. DRIVER AND RECEIVER WAVEFORMS, HIGH TO LOW

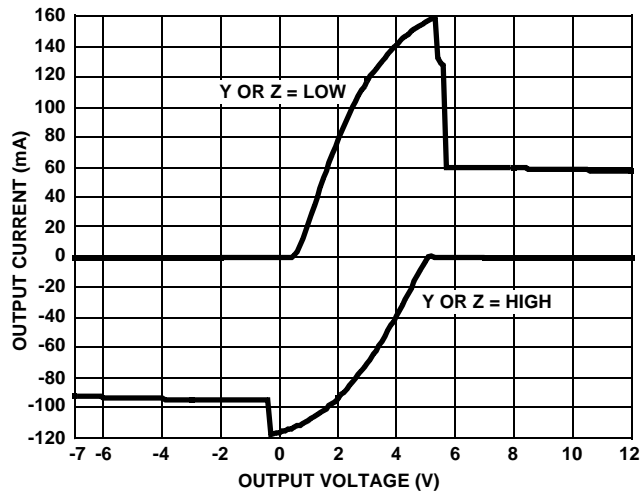
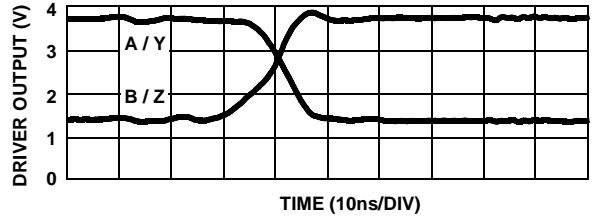
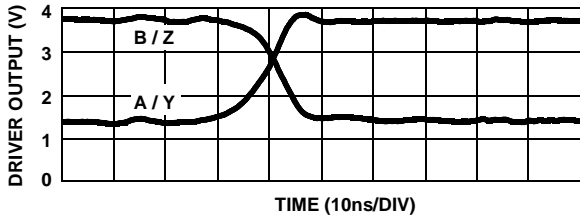

FIGURE 17. DRIVER OUTPUT CURRENT vs SHORT CIRCUIT VOLTAGE

### Die Characteristics

SUBSTRATE POTENTIAL (POWERED UP):

GND

TRANSISTOR COUNT:

518

PROCESS:

Si Gate CMOS

# ISL4485E

## Small Outline Plastic Packages (SOIC)

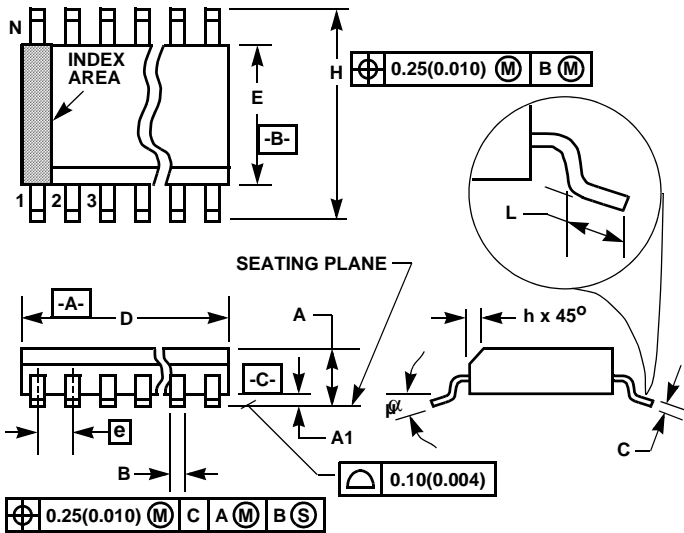

### M8.15 (JEDEC MS-012-AA ISSUE C) 8 LEAD NARROW BODY SMALL OUTLINE PLASTIC PACKAGE

SYMBOL	INCHES		MILLIMETERS		NOTES
	MIN	MAX	MIN	MAX	
A	0.0532	0.0688	1.35	1.75	-
A1	0.0040	0.0098	0.10	0.25	-
B	0.013	0.020	0.33	0.51	9
C	0.0075	0.0098	0.19	0.25	-
D	0.1890	0.1968	4.80	5.00	3
E	0.1497	0.1574	3.80	4.00	4
e	0.050 BSC		1.27 BSC		-
H	0.2284	0.2440	5.80	6.20	-
h	0.0099	0.0196	0.25	0.50	5
L	0.016	0.050	0.40	1.27	6
N	8		8		7
$\alpha$	0°	8°	0°	8°	-

#### NOTES:

1. Symbols are defined in the "MO Series Symbol List" in Section 2.2 of Publication Number 95.
2. Dimensioning and tolerancing per ANSI Y14.5M-1982.
3. Dimension "D" does not include mold flash, protrusions or gate burrs. Mold flash, protrusion and gate burrs shall not exceed 0.15mm (0.006 inch) per side.
4. Dimension "E" does not include interlead flash or protrusions. Interlead flash and protrusions shall not exceed 0.25mm (0.010 inch) per side.
5. The chamfer on the body is optional. If it is not present, a visual index feature must be located within the crosshatched area.
6. "L" is the length of terminal for soldering to a substrate.
7. "N" is the number of terminal positions.
8. Terminal numbers are shown for reference only.
9. The lead width "B", as measured 0.36mm (0.014 inch) or greater above the seating plane, shall not exceed a maximum value of 0.61mm (0.024 inch).
10. Controlling dimension: MILLIMETER. Converted inch dimensions are not necessarily exact.

Rev. 0 12/93

All Intersil U.S. products are manufactured, assembled and tested utilizing ISO9000 quality systems.  
Intersil Corporation's quality certifications can be viewed at [www.intersil.com/design/quality](http://www.intersil.com/design/quality)

*Intersil products are sold by description only. Intersil Corporation reserves the right to make changes in circuit design, software and/or specifications at any time without notice. Accordingly, the reader is cautioned to verify that data sheets are current before placing orders. Information furnished by Intersil is believed to be accurate and reliable. However, no responsibility is assumed by Intersil or its subsidiaries for its use; nor for any infringements of patents or other rights of third parties which may result from its use. No license is granted by implication or otherwise under any patent or patent rights of Intersil or its subsidiaries.*

For information regarding Intersil Corporation and its products, see [www.intersil.com](http://www.intersil.com)