

19-1547; Rev 0; 10/99



Low-Cost, Ultra-Small, 3 μ A Single-Supply Comparators

General Description

The MAX9075/MAX9077 single/dual comparators are optimized for +3V and +5V single-supply applications. These comparators have a 580ns propagation delay and consume just 3 μ A per comparator. The combination of low-power, single-supply operation down to +2.1V, and ultra-small footprint makes these devices ideal for all portable applications.

The MAX9075/MAX9077 have a common-mode input voltage range of -0.2V to $V_{CC} - 1.2V$. Unlike many comparators, there is no differential clamp between the inputs, allowing the differential input voltage range to extend Rail-to-Rail[®]. All inputs and outputs tolerate a continuous short-circuit fault condition to either rail.

The design of the output stage limits supply-current surges while switching (typical of many other comparators), minimizing power consumption under dynamic conditions. Large internal push-pull output drivers allow rail-to-rail output swing with loads up to 2mA, making these devices ideal for interface with TTL/CMOS logic.

The MAX9075 single comparator is available in 5-pin SC70 and SOT23-5 packages, while the MAX9077 dual comparator is available in 8-pin SOT23-8 and SO packages.

Applications

- Battery-Powered Systems
- Threshold Detectors/Discriminators
- Keyless Entry Systems
- IR Receivers
- Digital Line Receivers

Pin Configurations

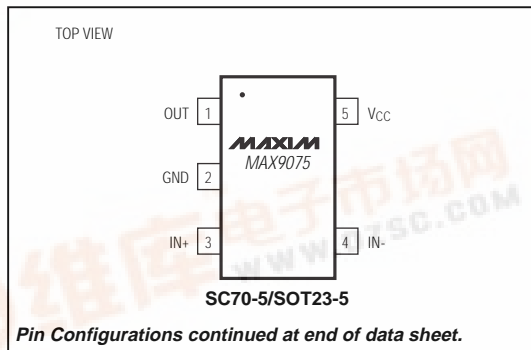

Features

- ◆ 580ns Propagation Delay from Only 3 μ A
- ◆ +2.1V to +5.5V Single-Supply Operation
- ◆ Ground-Sensing Inputs
- ◆ Rail-to-Rail Outputs
- ◆ No Output Phase Inversion for Overdriven Inputs
- ◆ No Differential Clamp Across Inputs
- ◆ Available in Ultra-Small Packages
 - 5-Pin SC70 (MAX9075)
 - 8-Pin SOT23 (MAX9077)

Ordering Information

PART	TEMP. RANGE	PIN-PACKAGE	TOP MARK
MAX9075EXK-T	-40°C to +85°C	5 SC70-5	AAC
MAX9075EUK-T	-40°C to +85°C	5 SOT23-5	ADLX
MAX9077EKA-T	-40°C to +85°C	8 SOT23-8	AAAD
MAX9077ESA	-40°C to +85°C	8 SO	—

Typical Operating Circuit

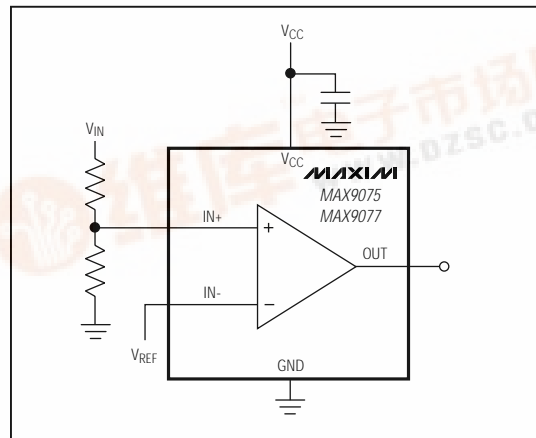

Maxim Integrated Products 1

For free samples & the latest literature: <http://www.maxim-ic.com>, or phone 1-800-998-8800.
For small orders, phone 1-800-835-8769.

MAX9075/MAX9077



Low-Cost, Ultra-Small, 3 μ A Single-Supply Comparators

ABSOLUTE MAXIMUM RATINGS

Supply Voltage	5-Pin SOT23 (derate 7.1mW/°C above +70°C).....	571mW
V _{CC} to GND	8-Pin SOT23 (derate 5.3mW/°C above +70°C).....	421mW
All Other Pins to GND.....	8-Pin SO (derate 5.88mW/°C above +70°C).....	471mW
Duration of Output Short Circuit to GND or V _{CC}	Operating Temperature Range	-40°C to +85°C
Continuous Power Dissipation (T _A = +70°C)	Storage Temperature Range	-65°C to +150°C
5-Pin SC70 (derate 2.5mW/°C above +70°C).....	Lead Temperature (soldering, 10sec)	+300°C

Stresses beyond those listed under "Absolute Maximum Ratings" may cause permanent damage to the device. These are stress ratings only, and functional operation of the device at these or any other conditions beyond those indicated in the operational sections of the specifications is not implied. Exposure to absolute maximum rating conditions for extended periods may affect device reliability.

ELECTRICAL CHARACTERISTICS

(V_{CC} = +5V, V_{CM} = -0.2V, T_A = T_{MIN} to T_{MAX}, unless otherwise noted. Typical values are at T_A = +25°C.) (Note 1)

PARAMETER	SYMBOL	CONDITIONS	MIN	TYP	MAX	UNITS
Operating Supply Voltage Range	V _{CC}	Inferred from PSRR	2.1		5.5	V
Supply Current per Comparator	I _{CC}	V _{CC} = 5V		3	5.2	μ A
			T _A = +25°C			
			T _A = T _{MIN} to T _{MAX}		6.6	
		V _{CC} = 3V		2.4		
Power-Supply Rejection Ratio	PSRR	2.1V \leq V _{CC} \leq 5.5V	54	77		dB
Common-Mode Voltage Range	V _{CMR}	(Note 2)	-0.2		V _{CC} - 1.2	V
Input Offset Voltage	V _{OS}			\pm 1	\pm 8	mV
Input Offset Current	I _{OS}			1		nA
Input Bias Current	I _B	V _{CM} = 0 (Note 3)		-5	-20	nA
Input Capacitance	C _{IN}			3		pF
Common-Mode Rejection Ratio	CMRR	-0.2V \leq V _{CM} \leq (V _{CC} - 1.2V)	60	82		dB
OUT_ Output Voltage High	V _{OH}	I _{SOURCE} = 2mA			V _{CC} - 0.4	V
OUT_ Output Voltage Low	V _{OL}	I _{SINK} = 2mA			0.4	V
Propagation Delay Low to High	t _{PD+}	C _{LOAD} = 10pF, overdrive = 100mV		580		ns
Propagation Delay High to Low	t _{PD-}	C _{LOAD} = 10pF, overdrive = 100mV		250		ns
Rise/Fall Time		C _{LOAD} = 10pF		1.6		ns

Note 1: All devices are 100% production tested at T_A = +25°C. All temperature limits are guaranteed by design.

Note 2: Inferred from CMRR. Either input can be driven to the absolute maximum limit without output inversion, as long as the other input is within the input voltage range.

Note 3: Guaranteed by design.

Low-Cost, Ultra-Small, 3 μ A Single-Supply Comparators

Typical Operating Characteristics

($V_{CC} = +5V$, $V_{CM} = 0$, 100mV overdrive, $T_A = +25^\circ C$, unless otherwise noted.)

MAX9075/MAX9077

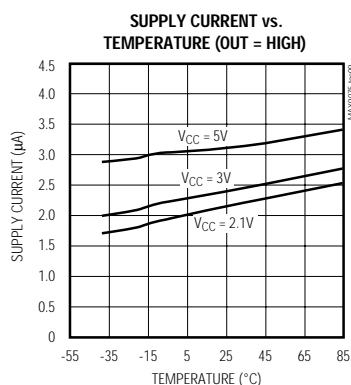
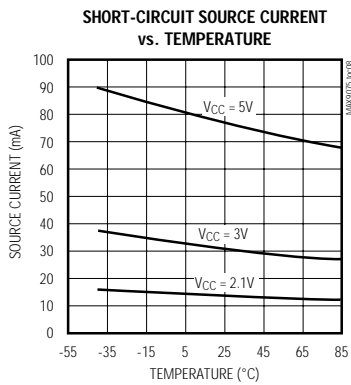
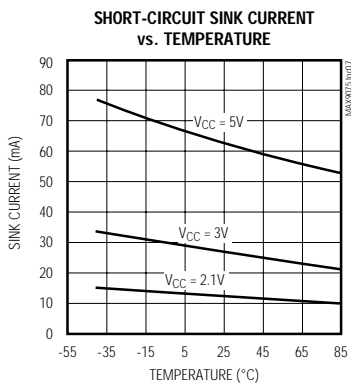
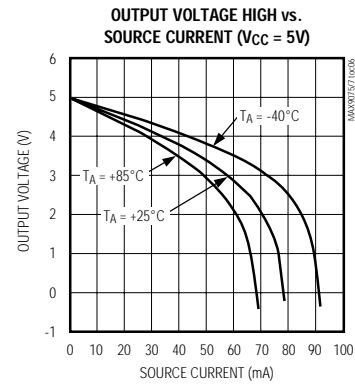
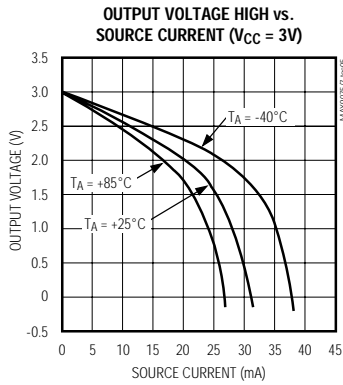
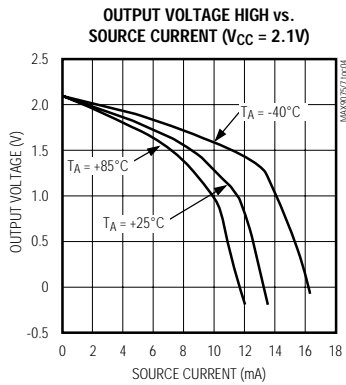
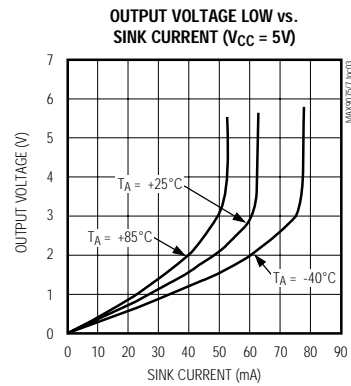
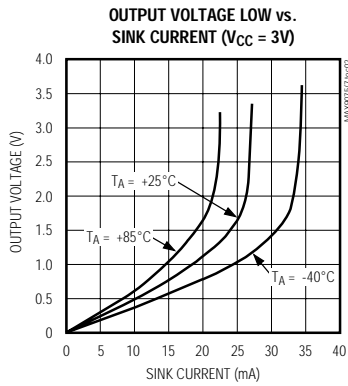
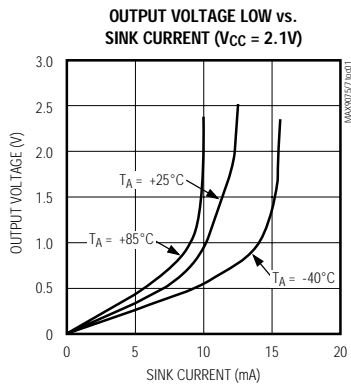

Low-Cost, Ultra-Small, 3 μ A Single-Supply Comparators

Typical Operating Characteristics (continued)
 ($V_{CC} = +5V$, $V_{CM} = 0$, 100mV overdrive, $T_A = +25^\circ C$, unless otherwise noted.)

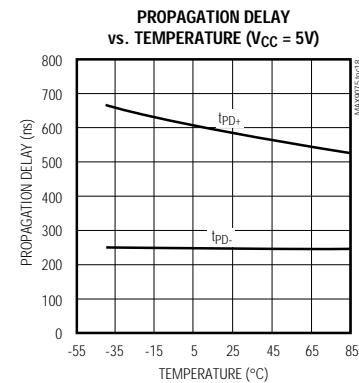
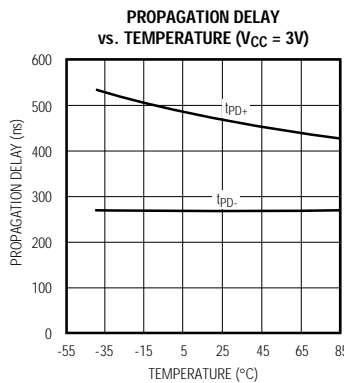
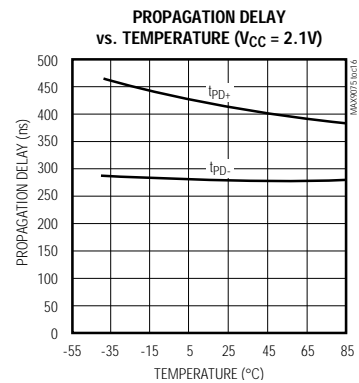
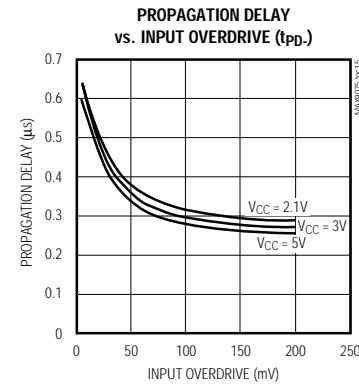
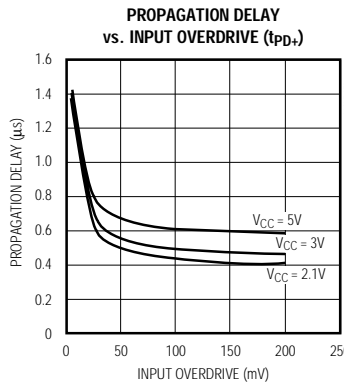
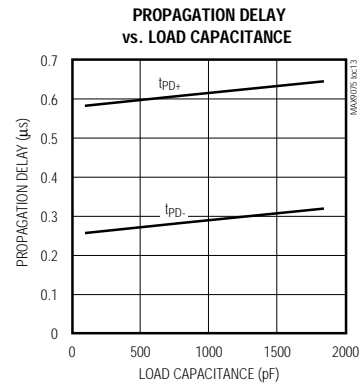
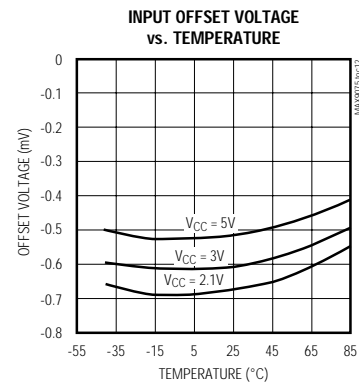
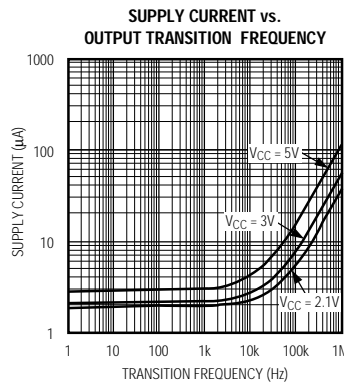
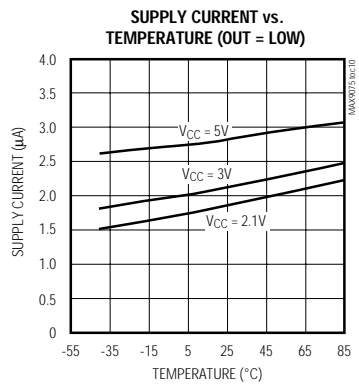

Low-Cost, Ultra-Small, 3 μ A Single-Supply Comparators

Typical Operating Characteristics (continued)
 (V_{CC} = +5V, V_{CM} = 0, 100mV overdrive, T_A = +25°C, unless otherwise noted.)

MAX9075/MAX9077

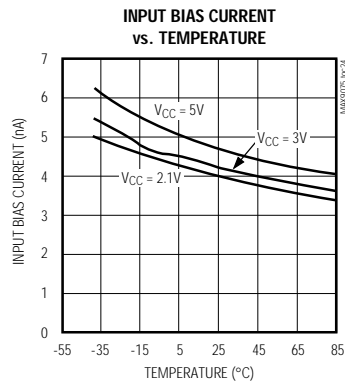
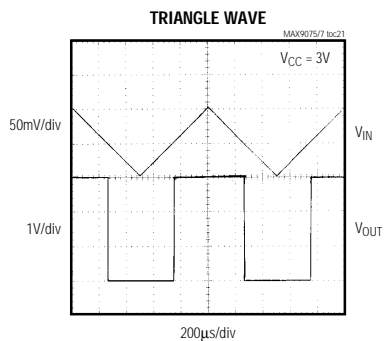
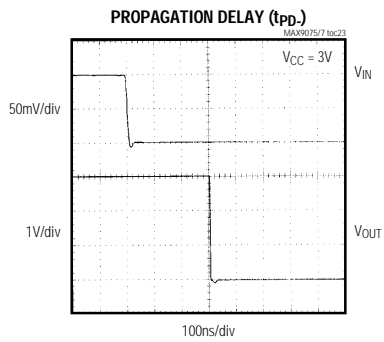
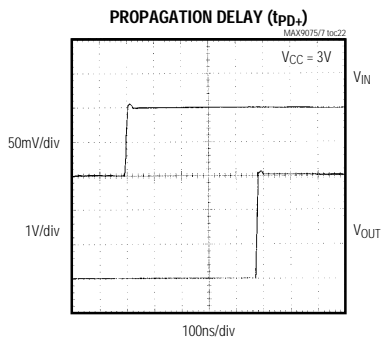
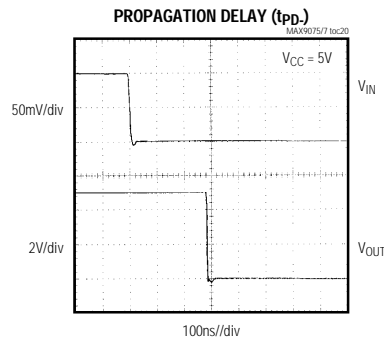
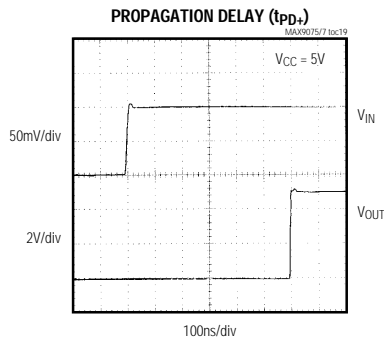

Low-Cost, Ultra-Small, 3 μ A Single-Supply Comparators

Pin Description

PIN				NAME	FUNCTION
MAX9075		MAX9077			
SOT23-5	SC70-5	SO	SOT23-8		
1	1	—	—	OUT	Comparator Output
—	—	1	1	OUTA	Output of Comparator A
2	2	4	2	GND	Ground
3	3	—	—	IN+	Noninverting Comparator Input
—	—	3	4	INA+	Noninverting Input of Comparator A
4	4	—	—	IN-	Inverting Comparator Input
—	—	2	3	INA-	Inverting Input of Comparator A
5	5	8	8	V _{CC}	Positive Supply Voltage
—	—	5	5	INB+	Noninverting Input of Comparator B
—	—	6	6	INB-	Inverting Input of Comparator B
—	—	7	7	OUTB	Output of Comparator B

Detailed Description

The MAX9075/MAX9077 feature a 580ns propagation delay from an ultra-low supply current of only 3 μ A per comparator. These devices are capable of single-supply operation in the +2.1V to +5.5V range. Large internal output drivers allow rail-to-rail output swing with up to 2mA loads. Both comparators offer a push-pull output that sinks and sources current.

Comparator Output

The MAX9075/MAX9077 are designed to maintain a low supply current during repeated transitions by limiting the shoot-through current.

Noise Considerations, Comparator Input

The input common-mode voltage range for these devices extends from -0.2V to V_{CC} - 1.2V. Unlike many other comparators, the MAX9075/MAX9077 can operate at any differential input voltage within these limits. Input bias current is typically -5nA if the input voltage is between the supply rails.

Although the comparators have a very high gain, useful gain is limited by noise. The comparator has a wide-band peak-to-peak noise of approximately 70 μ V.

Applications Information

Adding Hysteresis

Hysteresis extends the comparator's noise margin by increasing the upper threshold and decreasing the lower threshold. A voltage divider from the output of the comparator sets the trip voltage. Therefore, the trip voltage is related to the output voltage. Set the hysteresis with three resistors using positive feedback, as shown in Figure 1.

The design procedure is as follows:

- 1) Choose R3. The leakage current of IN+ may cause a small error; however, the current through R3 can be approximately 500nA and still maintain accuracy. The added supply current due to the circuit at the trip point is V_{CC}/R3; 10M Ω is a good practical value for R3, as this keeps the current well below the supply current of the chip.
- 2) Choose the hysteresis voltage (V_{HYS}), which is the voltage between the upper and lower thresholds. In this example, choose V_{HYS} = 50mV and assume V_{REF} = 1.2V and V_{CC} = 5V.
- 3) Calculate R1 as follows:

$$R1 = R3 \cdot V_{HYS} / V_{CC} = 10M\Omega \cdot 0.05 / 5 = 100k\Omega$$

Low-Cost, Ultra-Small, 3µA Single-Supply Comparators

- 4) Choose the threshold voltage for V_{IN} rising (V_{THR}). In this example, choose $V_{THR} = 3V$.
 5) Calculate $R2$ as follows:

$$R2 = 1 / \{ [V_{THR} / (V_{REF} \cdot R1)] - 1/R1 - 1/R3 \} = 1 / \{ [3 / (1.2 \cdot 100k)] - 1/100k - 1/10M \} = 67.114k\Omega$$

A 1% preferred value is 64.9kΩ.

- 6) Verify the threshold voltages with these formulas:

V_{IN} rising:

$$V_{THR} = V_{REF} \cdot R1 (1/R1 + 1/R2 + 1/R3)$$

V_{IN} falling:

$$V_{THF} = V_{THR} - (R1 \cdot V_{CC}) / R3$$

- 7) Check the error due to input bias current (5nA). If the error is too large, reduce $R3$ and recalculate.

$$V_{TH} = I_B (R1 \cdot R2 \cdot R3) / (R1 + R2 + R3) = 0.2mV$$

Board Layout and Bypassing

Use 10nF power-supply bypass capacitors. Use 100nF bypass capacitors when supply impedance is high, when supply leads are long, or when excessive noise is expected on the supply lines. Minimize signal trace lengths to reduce stray capacitance. Minimize the capacitive coupling between $IN-$ and OUT . For slow-moving input signals (rise time > 1ms) use a 1nF capacitor between $IN+$ and $IN-$.

Chip Information

TRANSISTOR COUNT: 86 (MAX9075)

142 (MAX9077)

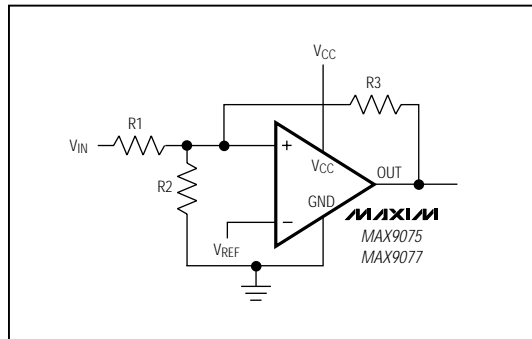
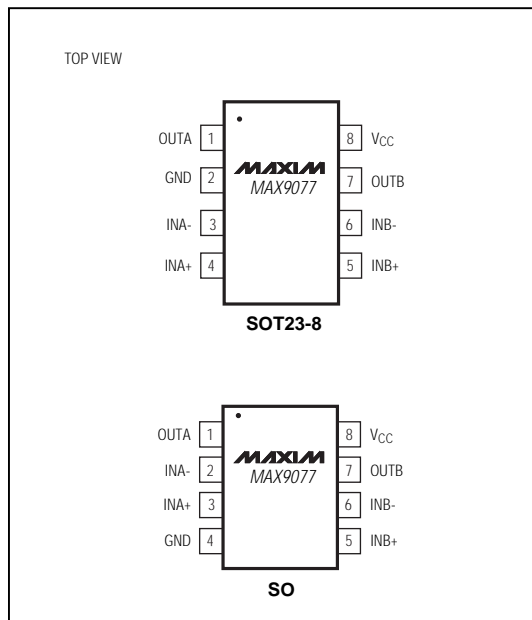

Figure 1. Adding Hysteresis

Pin Configurations (cont.)



MAX9075/MAX9077

Low-Cost, Ultra-Small, 3 μ A Single-Supply Comparators

Package Information

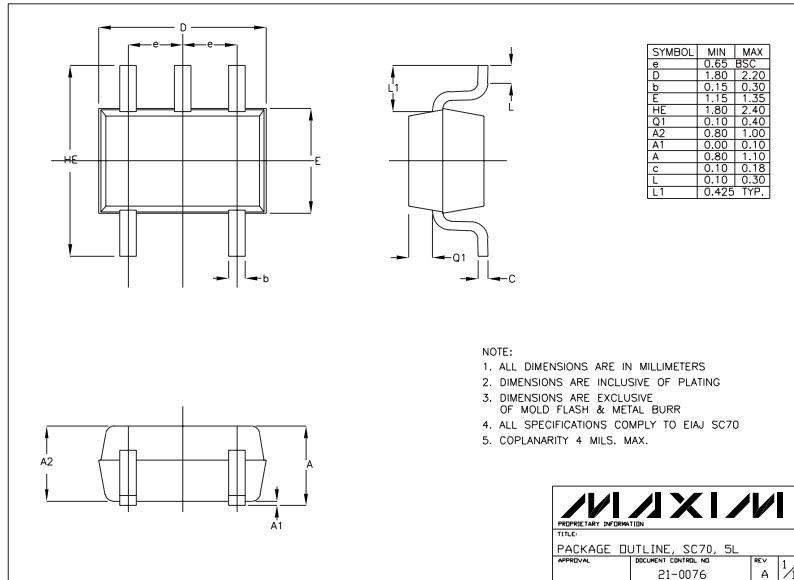

SC70-5L PDS

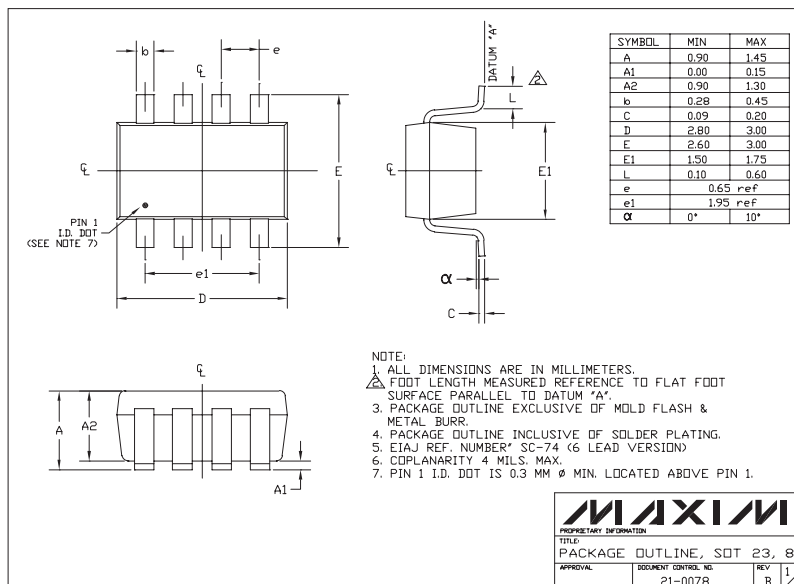

SDT23-8L PDS

Maxim cannot assume responsibility for use of any circuitry other than circuitry entirely embodied in a Maxim product. No circuit patent licenses are implied. Maxim reserves the right to change the circuitry and specifications without notice at any time.

8 Maxim Integrated Products, 120 San Gabriel Drive, Sunnyvale, CA 94086 408-737-7600