

**OBSOLETE PRODUCT
NO RECOMMENDED REPLACEMENT**
contact our Technical Support Center at
1-888-INTERSIL or www.intersil.com/tsc

December 1995, Rev. E

FN7033

730MHz Closed Loop Buffer

élantec

The EL2072 is a wide bandwidth, fast settling monolithic buffer built using an advanced complementary bipolar

process. This buffer is closed loop to achieve lower output impedance and higher gain accuracy. Designed for closed-loop unity gain, the EL2072 has a 730MHz -3dB bandwidth and 5ns settling to 0.2% while consuming only 15mA of supply current.

The EL2072 is an obvious high-performance solution for video distribution and line-driving applications. With low 15mA supply current and a 70mA output drive, performance in these areas is assured.

The EL2072's settling to 0.2% in 5ns, low distortion, and ability to drive capacitive loads make it an ideal flash A/D driver. The wide 730MHz bandwidth and extremely linear phase allow unmatched signal fidelity.

The EL2072 can be used inside an amplifier loop or PLL as its wide bandwidth and fast rise time have minimal effect on loop dynamics.

Elantec products and facilities comply with MIL-I-45028A, and other applicable quality specifications. For information on Elantec's processing, see Elantec document QRA-1: Elantec's Processing, Monolithic Integrated Circuits.

Pinout

**EL2072
(8-PIN PDIP SO)**
TOP VIEW

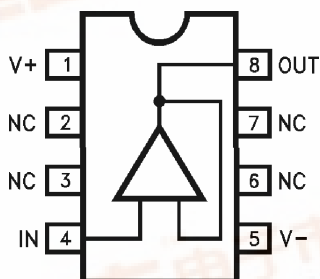

Manufactured under U.S. Patent No. 4,893,091

Features

- 730MHz -3dB bandwidth (0.5V_{PP})
- 5ns settling to 0.2%
- V_S = ±5V @ 15mA
- Low distortion: HD2, HD3 of -65dBc at 20MHz
- Overload/short-circuit protected
- Closed-loop, unity gain
- Low cost
- Direct replacement for CLC110

Applications

- Video buffer
- Video distribution
- HDTV buffer
- High-speed A/D buffer
- Photodiode, CCD preamps
- IF processors
- High-speed communications

Ordering Information

PART NUMBER	TEMP. RANGE	PACKAGE	PKG. NO.
EL2072CN	-40°C to +85°C	8-Pin PDIP	MDP0031
EL2072CS	-40°C to +85°C	8-Pin SO	MDP0027

EL2072

Absolute Maximum Ratings ($T_A = 25^\circ\text{C}$)

Supply Voltage (V_S) $\pm 7\text{V}$

Output Current

Output is short-circuit protected to ground, however, maximum reliability is obtained if I_{OUT} does not exceed 70mA.

Input Voltage $\pm V_S$

Operating Temperature -40°C to $+85^\circ\text{C}$

Junction Temperature 175°C

Storage Temperature -60°C to $+150^\circ\text{C}$

Thermal Resistance $\theta_{JA} = 95^\circ\text{C/W}$ PDIP

..... $\theta_{JA} = 175^\circ\text{C/W}$ SO

Note: See EL2071/EL2171 for Thermal Impedance curves.

CAUTION: Stresses above those listed in "Absolute Maximum Ratings" may cause permanent damage to the device. This is a stress only rating and operation of the device at these or any other conditions above those indicated in the operational sections of this specification is not implied.

IMPORTANT NOTE: All parameters having Min/Max specifications are guaranteed. Typical values are for information purposes only. Unless otherwise noted, all tests are at the specified temperature and are pulsed tests, therefore: $T_J = T_C = T_A$

DC Electrical Specifications $V_S = \pm 5\text{V}$, $R_L = 100\Omega$, $R_S = 50\Omega$ unless otherwise specified

PARAMETER	DESCRIPTION	TEST CONDITIONS	TEMP	MIN	TYP	MAX	UNITS
V_{OS}	Output Offset Voltage		25°C		2.0	8.0	mV
			T_{MIN}			16.0	mV
			T_{MAX}			13.0	mV
TCV_{OS}	Average Offset Voltage Drift		$25^\circ\text{C} - T_{MAX}$		20.0	50.0	$\mu\text{V}/^\circ\text{C}$
			$25^\circ\text{C} - T_{MIN}$		20.0	100.0	
I_B	Input Bias Current		25°C , T_{MAX}		10.0	50.0	μA
			T_{MIN}			100.0	μA
TCI_B	Average Input Bias Current Drift		$25^\circ\text{C} - T_{MAX}$		200.0	300.0	$\text{nA}/^\circ\text{C}$
			$25^\circ\text{C} - T_{MIN}$		200.0	700.0	
A_V	Small Signal Gain	$R_L = 100\Omega$	25°C	0.96	0.98		V/V
			T_{MIN} , T_{MAX}	0.95			V/V
ILIN	Integral End Point linearity	$\pm 2\text{V F.S.}$	25°C		0.2	0.4	%F.S.
			T_{MIN}			0.8	%F.S.
			T_{MAX}			0.3	%F.S.
PSRR	Power Supply Rejection Ratio		All	45.0	65.0		dB
I_S	Supply Current—Quiescent	No Load	All		15.0	20.0	mA
R_{IN}	Input Resistance		25°C	100.0	160.0		$\text{k}\Omega$
			T_{MIN}	50.0			$\text{k}\Omega$
			T_{MAX}	200.0			$\text{k}\Omega$
C_{IN}	Input Capacitance		25°C		1.6	2.2	pF
			T_{MIN} , T_{MAX}			2.5	pF
R_{OUT}	Output Impedance (DC)		25°C		2.0	3.0	Ω
			T_{MIN} , T_{MAX}			3.5	Ω
I_{OUT}	Output Current		25°C , T_{MAX}	50.0	70.0		mA
			T_{MIN}	45.0			mA
V_{OUT}	Output Voltage Swing	$R_L = 100\Omega$	25°C , T_{MAX}	± 3.2	± 4.0		V
			T_{MIN}	± 3.0			V

EL2072

AC Electrical Specifications $V_S = \pm 5V$, $R_L = 100\Omega$, $R_S = 50\Omega$ unless otherwise specified

PARAMETER	DESCRIPTION	TEST CONDITIONS	TEMP	MIN	TYP	MAX	UNITS
FREQUENCY RESPONSE							
SSBW	-3dB Bandwidth ($V_{OUT} < 0.5V_{PP}$)		25°C	400.0	730.0		MHz
			T_{MIN}	400.0			MHz
			T_{MAX}	300.0			MHz
LSBW	-3dB Bandwidth ($V_{OUT} = 5.0V_{PP}$)		25°C	55.0	90.0		MHz
			T_{MIN}, T_{MAX}	50.0			MHz
GAIN FLATNESS							
GFPL	Peaking $V_{OUT} < 0.5V_{PP}$	$< 200MHz$	25°C		0.0	0.5	dB
			T_{MAX}			0.6	dB
			T_{MIN}			0.8	dB
GFR	Rolloff $V_{OUT} < 0.5V_{PP}$	$< 200MHz$	25°C		0.0	0.8	dB
			T_{MIN}			1.0	dB
			T_{MAX}			1.2	dB
GDL	Group Delay	$< 200MHz$	25°C, T_{MIN}		0.75	1.0	ns
			T_{MAX}			1.2	ns
LPD	Linear Phase Deviation $V_{OUT} < 0.5V_{PP}$	$< 200MHz$	25°C, T_{MIN}		0.7	1.5	°
			T_{MAX}			2.0	°
TIME-DOMAIN RESPONSE							
TR1, TF1	Rise Time, Fall Time Input Signal Rise/Fall = 300ps	0.5V Step	25°C, T_{MIN}		0.4	1.0	ns
			T_{MAX}			1.4	ns
TR2, TF2	Rise Time, Fall Time Input Signal Rise/Fall δ 1ns	5.0V Step	25°C		4.5	7.5	ns
			T_{MIN}, T_{MAX}			8.5	ns
TS1	Settling Time to 0.2% Input Signal Rise/Fall δ 1ns	2.0V Step	All		5.0	10.0	ns
OS	Overshoot Input Signal Rise/Fall = 300ps	0.5V Step	25°C		0.0	10.0	%
			T_{MIN}, T_{MAX}			15.0	%
SR	Slew Rate		25°C	500.0	800.0		V/ μ s
			T_{MIN}, T_{MAX}	450.0			V/ μ s
DISTORTION							
HD2	2nd Harmonic Distortion at 20MHz	2V _{PP}	25°C		-55.0	-50.0	dBc
			T_{MIN}			-48.0	dBc
			T_{MAX}			-55.0	dBc
HD2A	2nd Harmonic Distortion at 50MHz	2V _{PP}	25°C, T_{MAX}		-50.0	-45.0	dBc
			T_{MIN}			-40.0	dBc
HD3	3rd Harmonic Distortion at 20MHz	2V _{PP}	25°C		-65.0	-55.0	dBc
			T_{MIN}, T_{MAX}			-55.0	dBc
HD3A	3rd Harmonic Distortion at 50MHz	2V _{PP}	25°C, T_{MIN}		-60.0	-50.0	dBc
			T_{MAX}			-45.0	dBc

EL2072

AC Electrical Specifications $V_S = \pm 5V$, $R_L = 100\Omega$, $R_S = 50\Omega$ unless otherwise specified (Continued)

PARAMETER	DESCRIPTION	TEST CONDITIONS	TEMP	MIN	TYP	MAX	UNITS
EQUIVALENT INPUT NOISE							
NF	Noise Floor > 100kHz		25°C, T_{MIN}		-158.0	-155.0	dBm (1Hz)
			T_{MAX}			-154.0	dBm (1Hz)
INV	Integrated Noise 100kHz to 200MHz		25°C, T_{MIN}		40.0	57.0	μV
			T_{MAX}			63.0	μV

Typical Performance Curves

Forward Gain and Phase

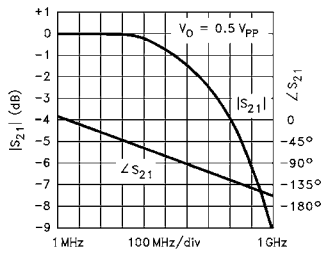

Gain Flatness & Deviation from Linear Phase

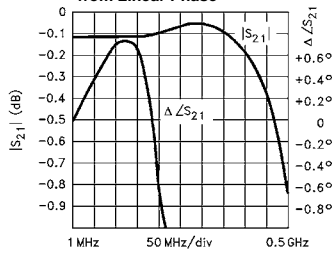

Reverse Gain and phase

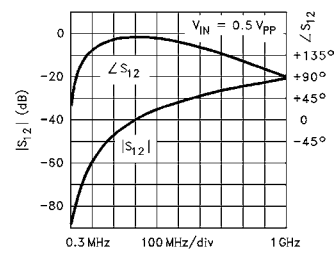

Input Impedance

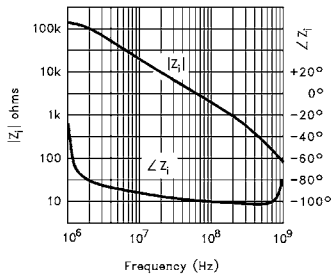

Output Impedance

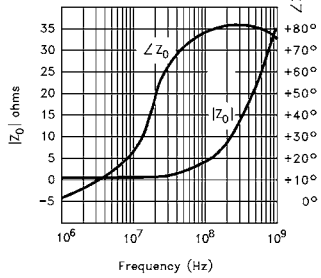

Recommended RS vs Load Capacitance

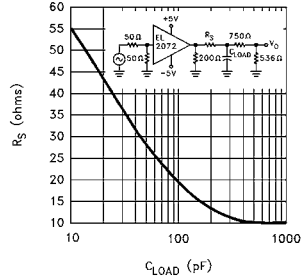

Integral Linearity Error

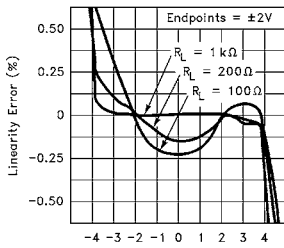

Frequency Response vs RLOAD

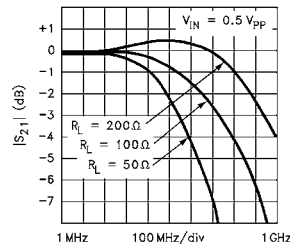

|S21| vs CLOAD with Recommended RS

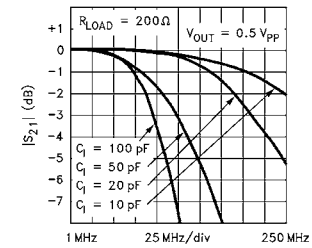

Small Signal Pulse Response

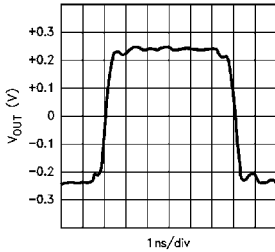

Large Signal Pulse Response

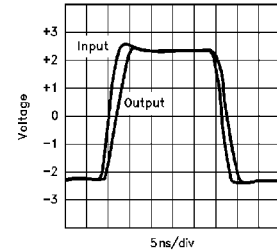

Long-Term Settling Time

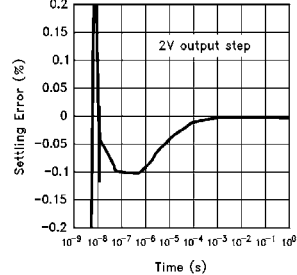

2nd Harmonic Distortion

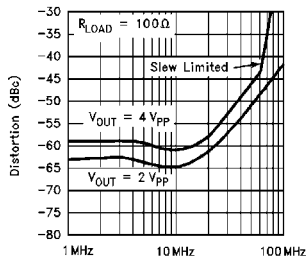

3rd Harmonic Distortion

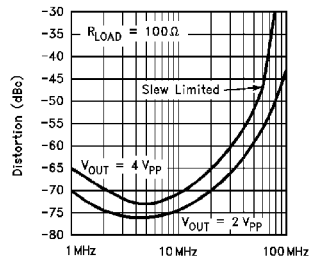

2-Tone, 3rd Order Intermodulation Intercept

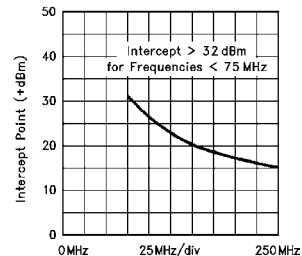

Burn-In Circuit

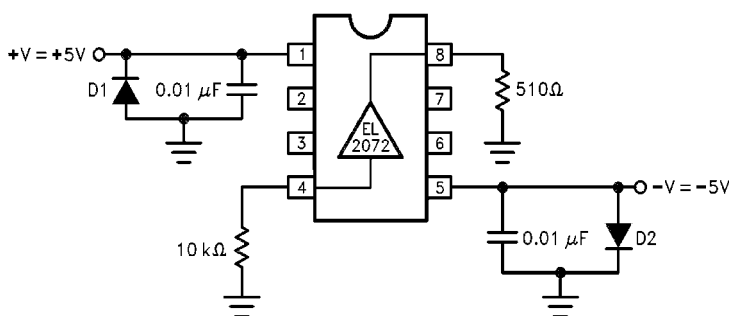

Printed Circuit Layout

As with any high-frequency device, good PCB layout is necessary for optimum performance. This is especially important for the EL2072, which has a typical bandwidth of 730MHz. Ground plane construction is a requirement, as is good power-supply bypassing close to the package. A closely-placed 0.01μF ceramic capacitor between each supply pin and the ground plane is usually sufficient decoupling.

Pins 2, 3, 6, and 7 should be connected to the ground-plane to minimize capacitive feedthrough, and all input and output traces should be laid out as transmission lines and terminated as close to the EL2072 package as possible.

Increasing capacitance on the output of the EL2072 will add phase shift, decreasing phase margin and increasing frequency-response peaking. A small series resistor before the capacitance decouples this effect, and should be used for large capacitance values. Please refer to the graphs for the appropriate resistor value to be used.

All Intersil U.S. products are manufactured, assembled and tested utilizing ISO9000 quality systems.
Intersil Corporation's quality certifications can be viewed at www.intersil.com/design/quality

Intersil products are sold by description only. Intersil Corporation reserves the right to make changes in circuit design, software and/or specifications at any time without notice. Accordingly, the reader is cautioned to verify that data sheets are current before placing orders. Information furnished by Intersil is believed to be accurate and reliable. However, no responsibility is assumed by Intersil or its subsidiaries for its use; nor for any infringements of patents or other rights of third parties which may result from its use. No license is granted by implication or otherwise under any patent or patent rights of Intersil or its subsidiaries.

For information regarding Intersil Corporation and its products, see www.intersil.com