

**élantec**  
HIGH PERFORMANCE ANALOG INTEGRATED CIRCUITS

# EL4390C

Triple 80 MHz Video Amplifier with DC Restore

EL4390C

## Features

- 80 MHz  $-3$  dB bandwidth for gains of 1 to 10
- 800 V/ $\mu$ s slew rate
- 15 MHz bandwidth flat to 0.1 dB
- Excellent differential gain and phase
- TTL/CMOS compatible DC restore function
- Available in 16 lead P-DIP, 16 lead SOL

## Applications

- RGB drivers requiring DC restoration
- RGB multiplexers requiring DC restoration
- RGB building blocks
- Video gain blocks requiring DC restoration
- Sync and color burst processing

## Ordering Information

Part No.	Temp. Range	Package	Outline #
EL4390CN	$-40^{\circ}\text{C}$ to $+85^{\circ}\text{C}$	16-Pin P-DIP	MDP0031
EL4390CM	$-40^{\circ}\text{C}$ to $+85^{\circ}\text{C}$	16-Lead SOL	MDP0027

## General Description

The EL4390C is three wideband current-mode feedback amplifiers optimized for video performance, each with a DC restore amplifier. The DC restore function is activated by a common TTL/CMOS compatible control signal while each channel has a separate restore reference.

Each amplifier can drive a load of  $150\Omega$  at video signal levels. The EL4390C operates on supplies as low as  $\pm 4\text{V}$  up to  $\pm 15\text{V}$ .

Being a current-mode feedback design, the bandwidth stays relatively constant at approximately 80MHz over the  $\pm 1$  to  $\pm 10$  gain range. The EL4390C has been optimized for use with  $1300\Omega$  feedback resistors.

## Connection Diagram

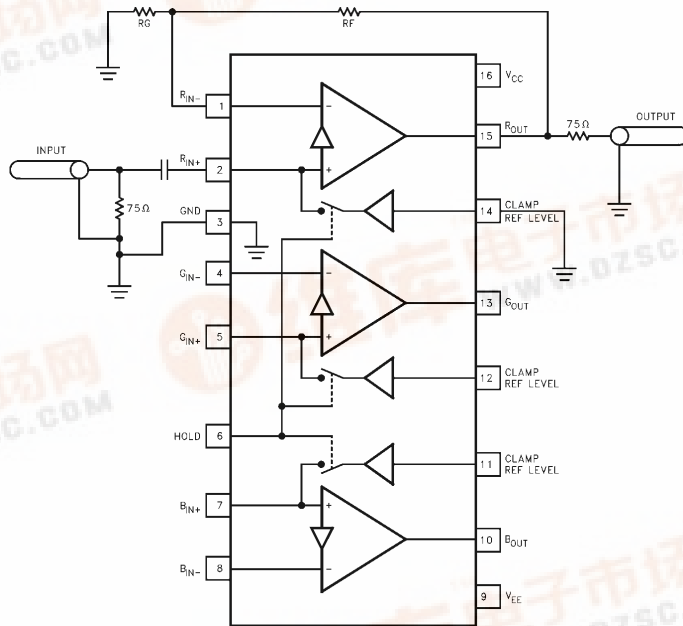

November 1994, Rev A

Note: All information contained in this data sheet has been carefully checked and is believed to be accurate as of the date of publication; however, this data sheet cannot be a "controlled document". Current revisions, if any, to these specifications are maintained at the factory and are available upon your request. We recommend checking the revision level before finalization of your design documentation.

© 1994 Elantec, Inc.



# EL4390C

## Triple 80 MHz Video Amplifier with DC Restore

### Absolute Maximum Ratings ( $T_A = 25^\circ\text{C}$ )

Voltage between $V_{S+}$ and $V_{S-}$	+33V	Internal Power Dissipation	See Curves
Voltage at $V_{S+}$	+18V	Operating Ambient Temp. Range	-40°C to +85°C
Voltage at $V_{S-}$	-18V	Operating Junction Temperature	150°C
Voltage between $V_{IN+}$ and $V_{IN-}$	±6V	Storage Temperature Range	-65°C to +150°C
Current into $V_{IN+}$ and $V_{IN-}$	5mA		

#### Important Note:

All parameters having Min/Max specifications are guaranteed. The Test Level column indicates the specific device testing actually performed during production and Quality inspection. Elantec performs most electrical tests using modern high-speed automatic test equipment, specifically the LTX77 Series system. Unless otherwise noted, all tests are pulsed tests, therefore  $T_J = T_C = T_A$ .

Test Level	Test Procedure
I	100% production tested and QA sample tested per QA test plan QCX0002.
II	100% production tested at $T_A = 25^\circ\text{C}$ and QA sample tested at $T_A = 25^\circ\text{C}$ , $T_{MAX}$ and $T_{MIN}$ per QA test plan QCX0002.
III	QA sample tested per QA test plan QCX0002.
IV	Parameter is guaranteed (but not tested) by Design and Characterization Data.
V	Parameter is typical value at $T_A = 25^\circ\text{C}$ for information purposes only.

### Open Loop DC Electrical Characteristics Supplies at ±15V, Load = 1kΩ

Parameter	Description	Temp	Min	Typ	Max	Test Level	Units
<b>Amplifier Section (not restored)</b>							
$V_{OS}$	Input Offset Voltage	+25°C		2	15	II	mV
$I_{B+}$	$I_{IN+}$ Input Bias Current	+25°C		0.2	5	II	μA
$I_{B-}$	$I_{IN-}$ Input Bias Current	+25°C		10	65	II	μA
$R_{OL}$	Transimpedance (Note 1)	+25°C	100	220		II	kΩ
$R_{IN-}$	$I_{N-}$ Resistance	+25°C		50		V	Ω
CMRR	Common-Mode Rejection Ratio (Note 2)	+25°C	50	56		II	dB
PSRR	Power Supply Rejection Ratio (Note 4)	+25°C	50	70		II	dB
$V_O$	Output Voltage Swing; $R_L = 1k\Omega$	+25°C	±12	±13		II	V
$I_{SC}$	Short-Circuit Current	+25°C	45	70	100	II	mA
$I_{SY}$	Supply Current (Quiescent)	+25°C	10	20	32	II	mA
<b>Restoring Section</b>							
$V_{OS, COMP}$	Composite Input Offset Voltage (Note 3)	+25°C		8	35	II	mV
$I_{B+, R}$	Restore $I_{N+}$ Input Bias Current	+25°C		0.2	5	II	μA
$I_{OUT}$	Restoring Current Available	+25°C	2	4		II	mA
PSRR	Power Supply Rejection Ratio (Note 4)	+25°C	50	70		II	dB
$G_{OUT}$	Conductance	+25°C		8		V	mA/V
$I_{SY, RES}$	Supply Current, Restoring	+25°C	10	23	37	II	mA
$V_{IL, RES}$	RES Logic Low Threshold	+25°C		1.0	1.4	II	V
$V_{IH, RES}$	RES Logic High Threshold	+25°C	1.4	1.8		II	V

# EL4390C

## Triple 80 MHz Video Amplifier with DC Restore

### Open Loop DC Electrical Characteristics Supplies at $\pm 15V$ , Load = $1K\Omega$ — Contd.

Parameter	Description	Temp	Min	Typ	Max	Test Level	Units
<b>Restoring Section</b>							
$I_{IL, RES}$	RES Input Current, Logic Low	+ 25°C		2	10	II	$\mu A$
$I_{IH, RES}$	RES Input Current, Logic High	+ 25°C		0.5	3	II	$\mu A$

Note 1: For current feedback amplifiers,  $A_{VOL} = R_{OL}/R_{IN}$ .

Note 2:  $V_{CM} = \pm 10V$  for  $V_S = \pm 15V$ .

Note 3: Measured from  $V_{CL}$  to amplifier output, while restoring.

Note 4:  $V_{OS}$  is measured at  $V_S = \pm 4.5V$  and  $V_S = \pm 16V$ , both supplies are changed simultaneously.

### Closed Loop AC Electrical Characteristics

Supplies at  $\pm 15V$ , Load =  $150\Omega$  and  $15 pF$ ,  $T_A = 25^\circ C$  (See note 7 re: test fixture)

Parameter	Description	Min	Typ	Max	Test Level	Units
<b>Amplifier Section</b>						
SR	Slew Rate (Note 5)		800		V	$V/\mu s$
SR	Slew Rate w/ $\pm 5V$ Supplies (Note 5)		550		V	$V/\mu s$
BW	Bandwidth, $-3dB$ , $A_V = 1$		95		V	MHz
	$\pm 5V$ Supplies, $-3dB$		72		V	MHz
BW	Bandwidth, $-0.1 dB$		20		V	MHz
	$\pm 5V$ Supplies, $-0.1dB$		14		V	MHz
dG	Differential Gain at 3.58 MHz		0.02		V	%
	at $\pm 5V$ Supplies (Note 6)		0.02		V	%
d $\theta$	Differential Phase at 3.58 MHz		0.03		V	(°)
	at $\pm 5V$ Supplies (Note 6)		0.06		V	(°)
<b>Restoring Section</b>						
$T_{RE}$	Time to Enable Restore		35		V	ns
$T_{RD}$	Time to Disable Restore		35		V	ns

Note 5: SR is measured at 20% to 80% of 4V pk-pk square wave, with  $A_V = 5$ ,  $R_F = 820\Omega$ ,  $R_G = 200\Omega$ .

Note 6: DC offset from  $-0.714V$  to  $+0.714V$ , AC amplitude is 286m Vp-p, equivalent to 40 ire.

Note 7: Test fixture was designed to minimize capacitance at the  $I_N$  input. A "good" fixture should have less than 2 pF of stray capacitance to ground at this very sensitive pin. See application notes for further details.

# ***EL4390C***

## ***Triple 80 MHz Video Amplifier with DC Restore***

**Table 1. Charge Storage Capacitor Value vs. Droop and Charging Rates**

Cap Value (nF)	Droop in 60 $\mu$ S (mV)	Charge in 2 $\mu$ S (mV)	Charge in 4 $\mu$ S (mV)
10	30	400	800
22	13.6	182	364
47	6.4	85	170
100	3.0	40	80
220	1.36	18	36

These numbers represent the worst case bias current, and the worst case charging current. Note that to get the full (2mA+) charging current, the clamp input must have >250mV of error voltage.

Note that the magnitude of the bias current will decrease as temperature increases.

The basic droop formula is :

$$V(\text{droop}) = I_{B+} \times (\text{Line time} - \text{Charge time}) / \text{capacitor value}$$

and the basic charging formula is:

$$V(\text{charge}) = I_{OUT} \times \text{Charge time} / \text{capacitor value}$$

Where  $I_{OUT}$  is:

$$I_{OUT} = (\text{Clamp voltage} - \text{IN+ voltage}) / 120$$

# EL4390C

## Triple 80 MHz Video Amplifier with DC Restore

### Typical Performance Curves

**Gain Flatness for Various  $R_F$**   
 $V_S = \pm 15V, A_V = 0 \text{ dB}$

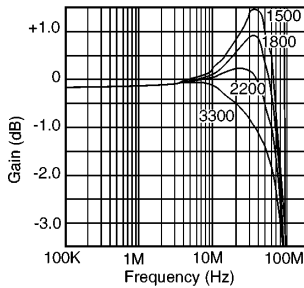

4390-2

**Gain Flatness for Various  $R_F$**   
 $V_S = \pm 5V, A_V = 0 \text{ dB}$

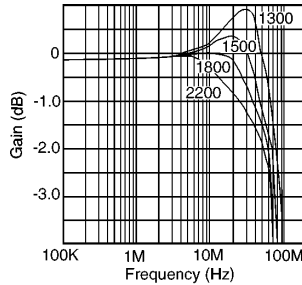

4390-3

**Gain Flatness for Various  $R_F$  and  $R_G$  Values**  
 $V_S = \pm 15V, A_V = 6 \text{ dB}$

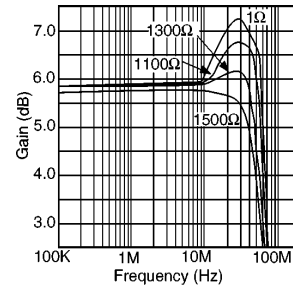

4390-4

**Gain Flatness for Various  $R_F$  and  $R_G$  Values**  
 $V_S = \pm 5V, A_V = 6 \text{ dB}$

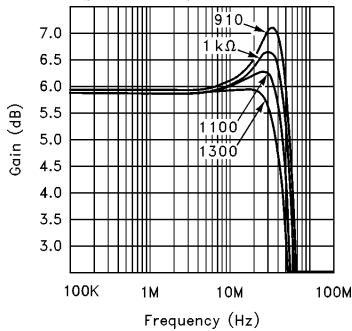

4390-6

**Phase Shift for  $A_V = 2$**   
 $R_F = R_G = 1300\Omega$

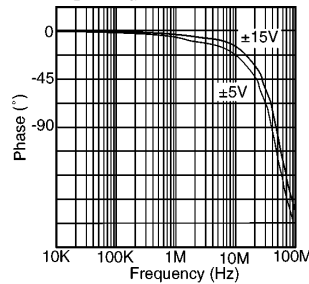

4390-5

**Phase Shift for  $A_V = 2$**   
 $R_F = R_G = 1000\Omega$   
at  $V_S = \pm 5V$  and  $V_S = \pm 15V$

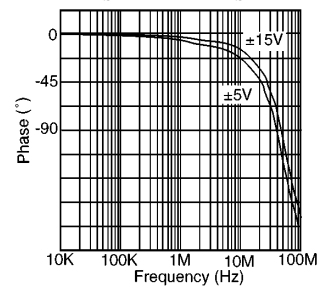

4390-7

**Gain Flatness**  
 $V_S = \pm 15V, A_V = 14 \text{ dB}$   
 $R_F/R_G$  as Shown

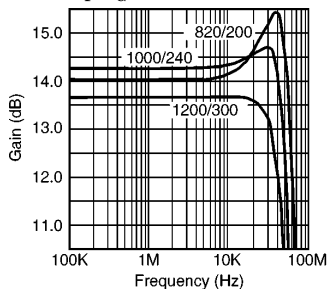

4390-8

**Gain Flatness**  
 $V_S = \pm 5V, A_V = 14 \text{ dB}$   
 $R_F/R_G$  as Shown

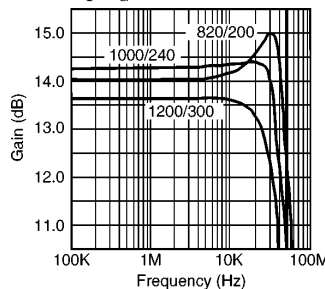

4390-9

**Phase Shift for  $A_V = 5 \text{ dB}$**   
 $R_F = 820\Omega, R_G = 200\Omega, V_S = \pm 5V$

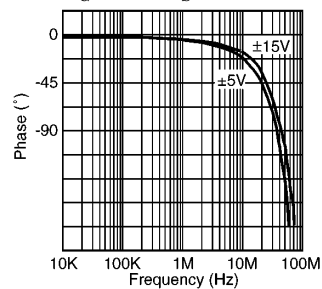

4390-10

# EL4390C

## Triple 80 MHz Video Amplifier with DC Restore

### Typical Performance Curves — Contd.

**Gain Flatness**  
 $V_S = \pm 5V$ ,  $A_V = 20$  dB,  
 $R_F/R_G$  as Shown

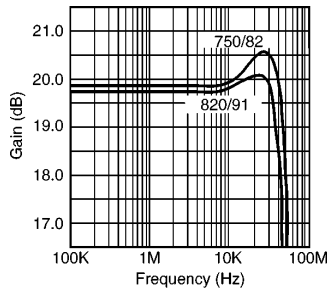

4390-11

**Gain Flatness**  
 $V_S = \pm 5V$ ,  $A_V = 26$  dB,  
 $R_F = 680\Omega$ ,  $R_G = 36\Omega$

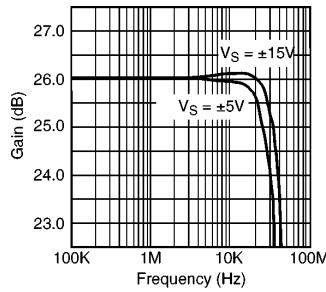

4390-12

**Differential Gain**  
 at  $V_S = \pm 15V$

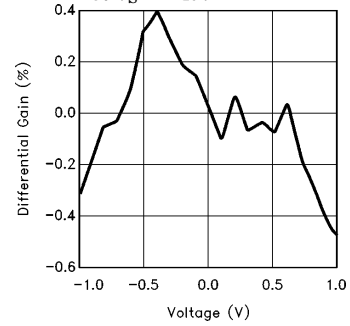

4390-17

**Differential Phase**  
 at  $V_S = \pm 15V$

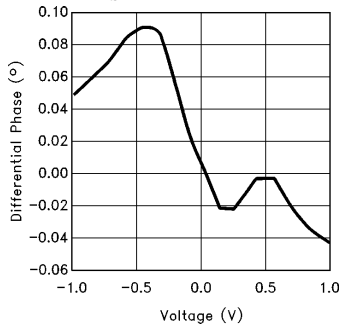

4390-18

**Differential Gain**  
 at  $V_S = \pm 5V$

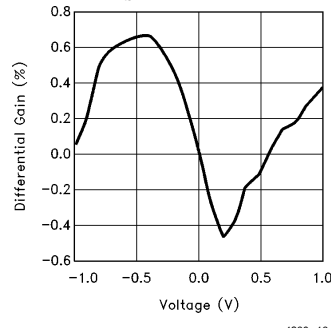

4390-19

**Differential Phase**  
 at  $V_S = \pm 5V$

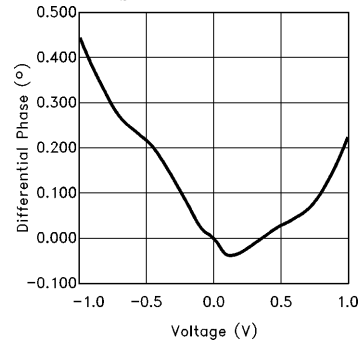

4390-20

**Frequency Response**  
 for Various  $C_{LOAD}$ ,  $V_S = \pm 15V$ ,  
 $R_F = R_G = 1300\Omega$

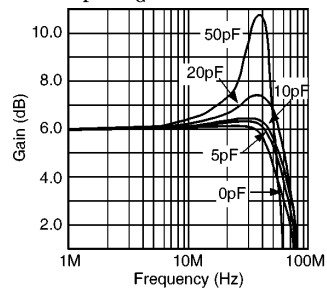

4390-13

**Frequency Response**  
 for Various  $C_{LOAD}$ ,  $V_S = \pm 5V$ ,  
 $R_F = R_G = 1300\Omega$

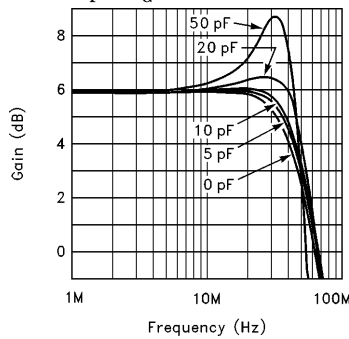

4390-14

**Crosstalk,**  
 Channel R and B to Channel G,  
 $V_S = \pm 5V$ ,  $R_F = 1300\Omega$

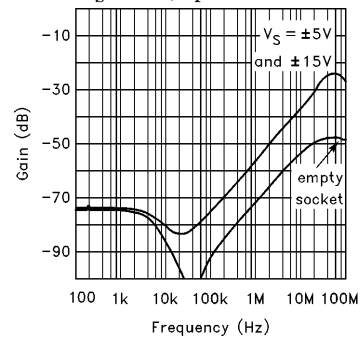

4390-15

# EL4390C

## Triple 80 MHz Video Amplifier with DC Restore

### Typical Performance Curves — Contd.

**Crosstalk, Channel R and G to Channel B,  $V_S = \pm 5V$ ,  $R_F = 1300\Omega$  and  $\pm 15V$**

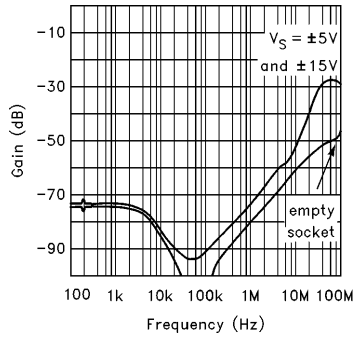

**$I_{N+}$  Input Impedance during HOLD,  $V_S = \pm 5V$**

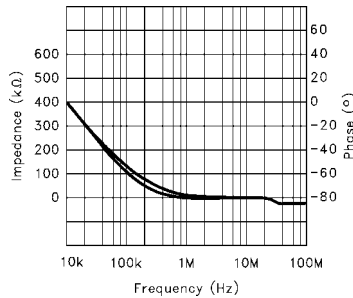

**$I_{N+}$  Input Impedance during SAMPLE,  $V_S = \pm 5V$**

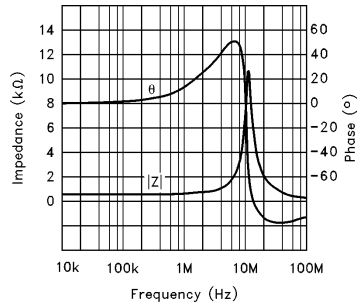

**Phase Shift at  $I_{N+}$  Pin during Restore,  $R_S = 75\Omega$  and  $150\Omega$ ,  $V_S = \pm 5V$**

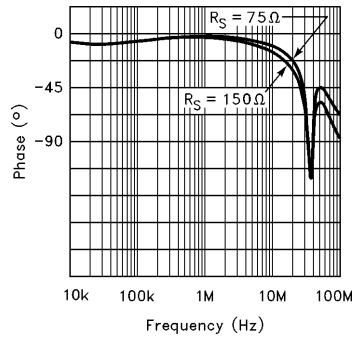

**$I_{OUT}$  Restoring vs Clamp Voltage at  $V_S = \pm 5V$**

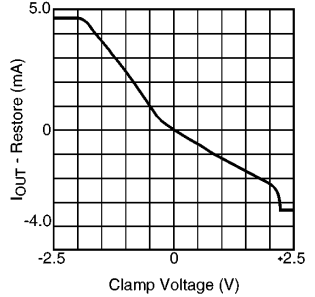

**Pulse Response with  $A_V = 2$ ,  $R_F = R_G = 1300\Omega$  at  $V_S = \pm 5V$**

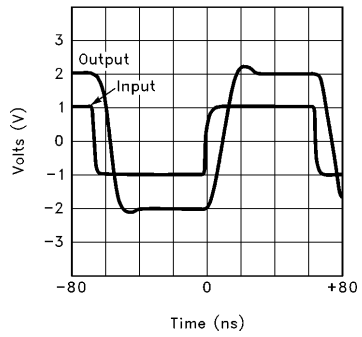

**Output during DC-Restoration, Showing DC Droop,  $R_F = R_G = 1300\Omega$ ,  $V_S = \pm 5V$**

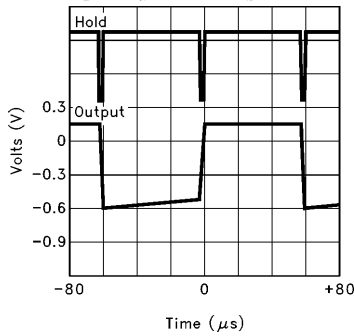

**Output during DC-Restoration,  $R_F = R_G = 1300\Omega$ ,  $V_S = \pm 5V$**

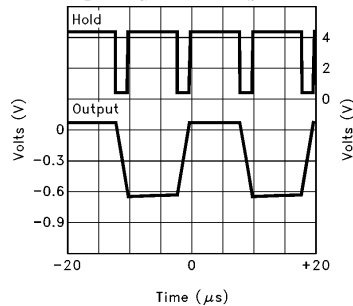

**Pulse Response with  $A_V = 5$ ,  $R_F = 820\Omega$  and  $R_G = 200\Omega$  at  $V_S = \pm 15V$**

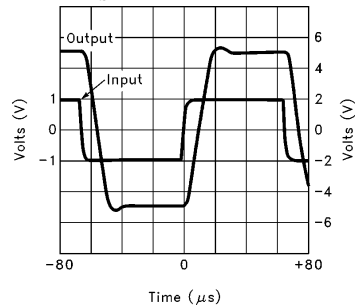

# EL4390C

Triple 80 MHz Video Amplifier with DC Restore

## Typical Performance Curves — Contd.

Maximum Power Dissipation vs Ambient Temperature—  
16-Pin PDIP

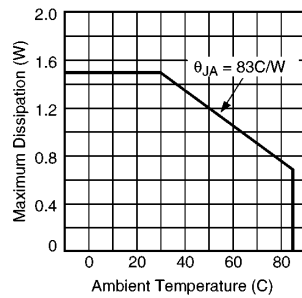

4390-29

Maximum Power Dissipation vs Ambient Temperature—  
16-Pin SOL

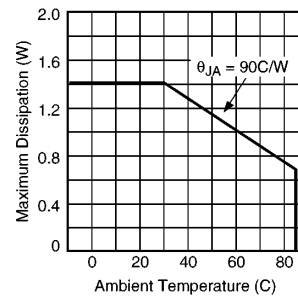

4390-30

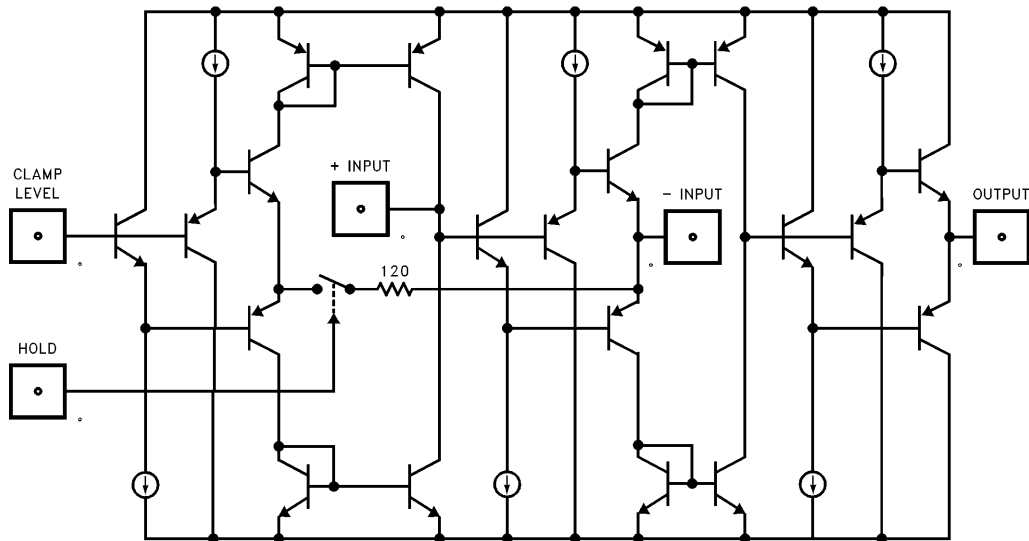

4390-31

Simplified Schematic of One Channel of EL4390



# EL4390C

## Triple 80 MHz Video Amplifier with DC Restore

### Applications Information

#### Circuit Operation

Each channel of the EL4390 contains a current feedback amplifier and a TTL/CMOS compatible clamp circuit. The current that the clamp can source or sink into the non-inverting input is approximately:

$$I = (V_{\text{CLAMP}} - V_{\text{IN}+}) / 120$$

So, when the non-inverting input is at the same voltage as the clamp reference, no current will flow, and hence no charge is added to the capacitor. When there is a difference in voltage, current will flow, in an attempt to cancel the error AT THE NON-INVERTING input. The amplifier's offset voltage and ( $I_{\text{B-}} \times R_{\text{F}}$ ) DC errors are not cancelled with this loop. It is purely a method of adding a controlled DC offset to the signal.

As well as the offset voltage error, which goes up with gain, and the  $I_{\text{B-}} \times R_{\text{F}}$  error which drops with gain, there is also the  $I_{\text{B+}}$  error term. Since the amplifier is capacitively coupled, this small current is slowly integrated and shows up as a very slow ramp voltage. Table below shows the output voltage drift in  $60\mu\text{S}$  for various values of coupling capacitor, all assuming the very worst  $I_{\text{B+}}$  current.

Table 1. Charge Storage Capacitor Value vs. Droop and Charging Rates

Cap Value (nF)	Droop in $60\mu\text{S}$ (mV)	Charge in $2\mu\text{S}$ (mV)	Charge in $4\mu\text{S}$ (mV)
10	30	400	800
22	13.6	182	364
47	6.4	85	170
100	3.0	40	80
220	1.36	18	36

In normal circuit operation, the picture content will also cause a slow change in voltage across the capacitor, so at every back porch time period, these error terms can be corrected.

When a signal source is being switched, eg. from two different surveillance cameras, it is recommended to synchronize the switching with the vertical blanking period, and to drive the HOLD pin (pin 6) low, during these lines. This will ensure that the system has been completely restored, regardless of the average intensity of the two pictures.

#### Application Hints

Figures 1 & 2 shows a three channel DC-restoring system, suitable for R-G-B or Y-U-V component video, or three synchronous composite signals.

Figure 1 shows the amplifiers configured for non-inverting gain, and Figure 2 shows the amplifiers configured for inverting gains. Note that since the DC-restoring function is accomplished by clamping the amplifier's non-inverting input, during the back porch period, any signal on the non-inverting input will be distorted. For this reason, it is recommended to use the inverting configuration for composite video, since this avoids the color burst being altered during the clamp time period.

Since all three amplifiers are monolithic, they run at the same temperature, and will have very similar input bias currents. This can be used to advantage, in situations where the droop voltage needs to be compensated, since a single trim circuit can be used for all three channels. A  $560\text{K}\Omega$  or similar value resistor helps to isolate each signal. See Figure 2. The advantage of compensating for the droop voltage, is that a smaller capacitor can be used, which allows a larger level restoration within one line. See Table 1 for values of capacitor and charge/droop rates.

# EL4390C

## Triple 80 MHz Video Amplifier with DC Restore

### Applications Information — Contd.

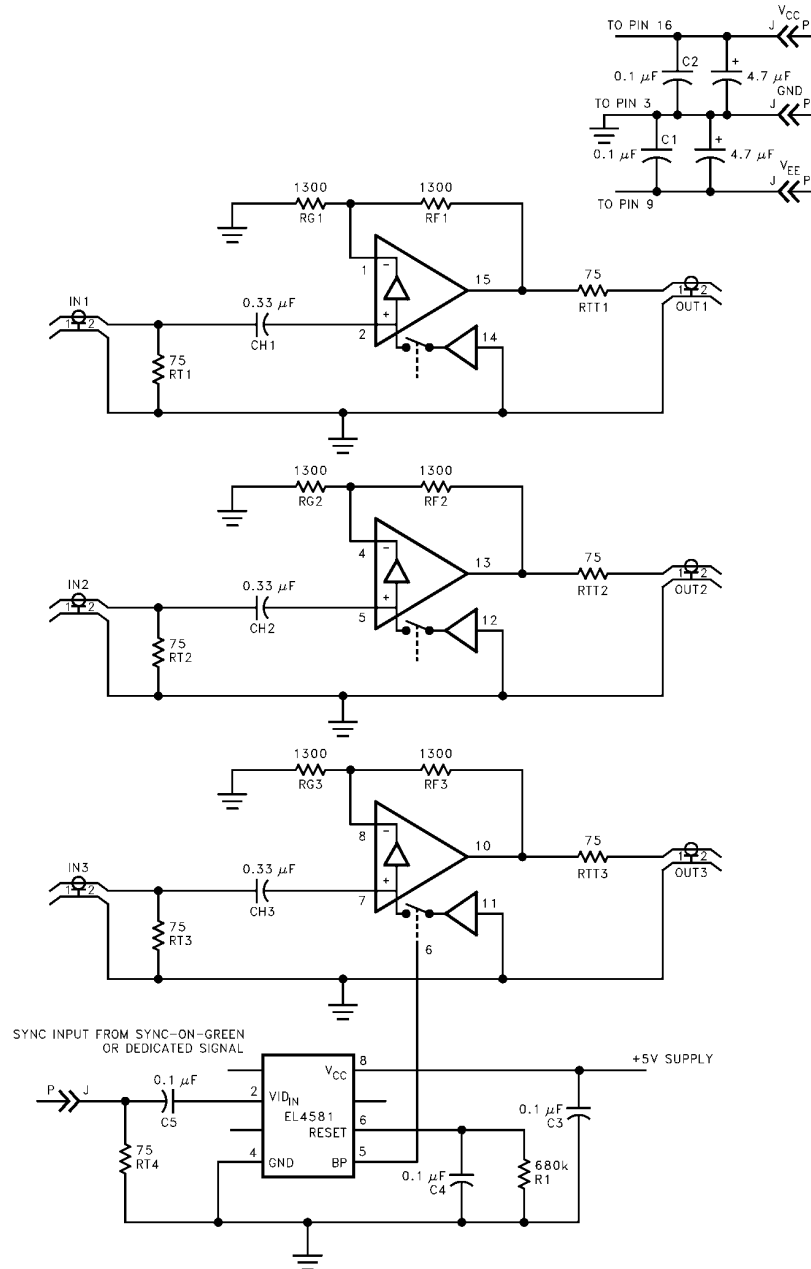

Figure 1

4390-32

# *EL4390C*

## *Triple 80 MHz Video Amplifier with DC Restore*

### Applications Information — Contd.

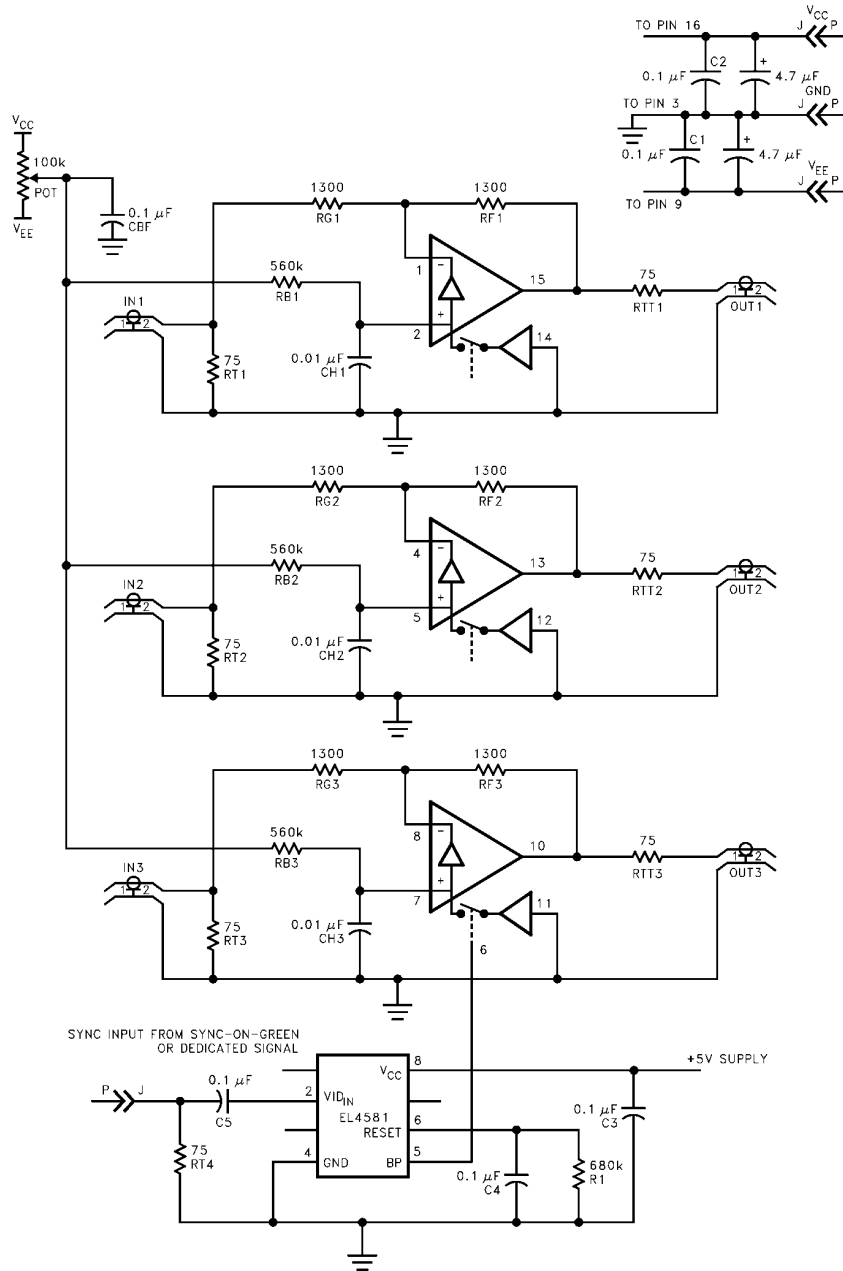

Figure 2

4390-33

# EL4390C

## Triple 80 MHz Video Amplifier with DC Restore

### Applications Information — Contd.

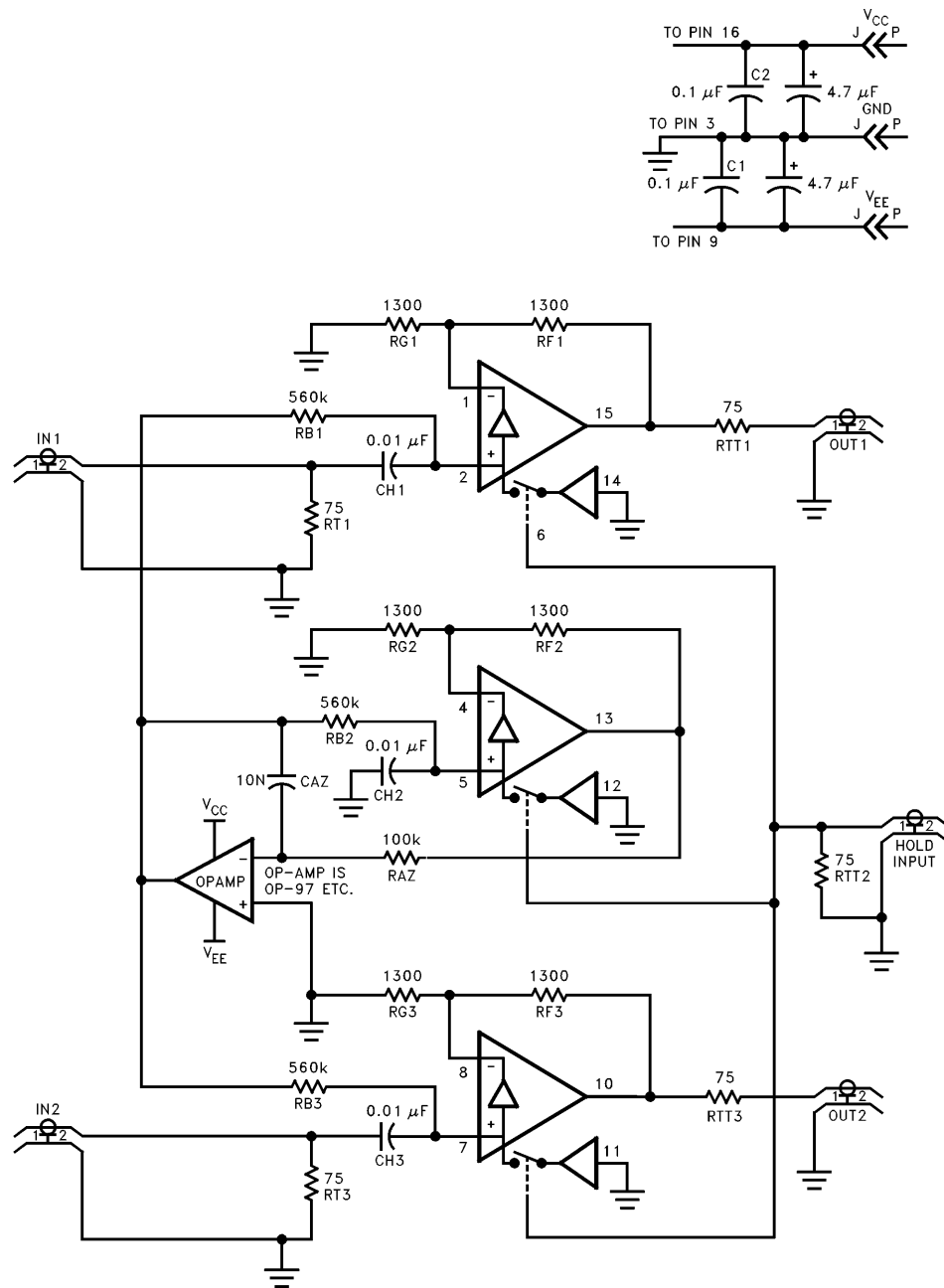

Figure 3

4390-94

# ***EL4390C***

## ***Triple 80 MHz Video Amplifier with DC Restore***

### **Applications Information — Contd.**

In Figure 3, one of the three channels is used, together with a low-offset op-amp, to automatically trim the bias current of the other two channels. The two remaining channels are shown in the non-inverting configuration, but could equally well be set to provide inverting gains. Two DC-restored channels are typically needed in fader applications. See the EL4094 and EL4095 for suitable, monolithic video faders.

### **Layout and Dissipation Considerations**

As with all high frequency circuits, the supplies should be bypassed with a  $0.1\mu\text{F}$  ceramic capacitor very close to the supply pins, and a  $4.7\mu\text{F}$  tantalum capacitor fairly close, to handle the high current surges. While a ground plane is recommended, the amplifier will work well with a "star" grounding scheme. The pin 3 ground is only used for the internal bias generator and the reference for the TTL compatible "HOLD" input.

As with all current feedback capacitors, all stray capacitance to the inverting inputs should be kept as low as possible, to avoid unwanted peaking at the output. This is especially true if the value of  $R_f$  has already been reduced to raise the bandwidth of the part, while tolerating some peaking. In this situation, additional capacitance on the inverting input can lead to an unstable amplifier.

Since there are three amplifiers all in one package, and each amplifier can sink or source typically more than 70mA, some care is needed to avoid excessive die temperatures. Sustained, DC currents, of over 30mA, are not recommended, due to the limited current handling capability of the metal traces inside the IC. Also, the short circuit protection can be tripped with currents as low as 45mA, which is seen as excessive distortion in the output waveform. As a quick rule of thumb, both the SOL and DIP 16 pin packages can dissipate about 1.4 watts at 25°C, and with  $\pm 15\text{V}$  supplies and a worst case quiescent current of 32mA, yields 0.96 watts, before any load is driven.

Dissipation of the EL4390 can be reduced by lowering the supply voltage. Although some performance is degraded at lower supplies, as seen in the characteristic curves, it is often found to be a useful compromise. The bandwidth can be recovered, by reducing the value of  $R_f$ , and  $R_G$  as appropriate.

# ***EL4390C***

***Triple 80 MHz Video Amplifier with DC Restore***

***EL4390C***

***Triple 80 MHz Video Amplifier with DC Restore***



# ***EL4390C***

***Triple 80 MHz Video Amplifier with DC Restore***

## **General Disclaimer**

Specifications contained in this data sheet are in effect as of the publication date shown. Elantec, Inc. reserves the right to make changes in the circuitry or specifications contained herein at any time without notice. Elantec, Inc. assumes no responsibility for the use of any circuits described herein and makes no representations that they are free from patent infringement.

***élantec***  
HIGH PERFORMANCE ANALOG INTEGRATED CIRCUITS

## **Elantec, Inc.**

1996 Tarob Court

Milpitas, CA 95035

Telephone: (408) 945-1323

(800) 333-6314

Fax: (408) 945-9305

European Office: 44-71-482-4596

## **WARNING — Life Support Policy**

Elantec, Inc. products are not authorized for and should not be used within Life Support Systems without the specific written consent of Elantec, Inc. Life Support systems are equipment intended to support or sustain life and whose failure to perform when properly used in accordance with instructions provided can be reasonably expected to result in significant personal injury or death. Users contemplating application of Elantec, Inc. products in Life Support Systems are requested to contact Elantec, Inc. factory headquarters to establish suitable terms & conditions for these applications. Elantec, Inc.'s warranty is limited to replacement of defective components and does not cover injury to persons or property or other consequential damages.