

Dual V_{COM} Amplifier & Gamma Reference Buffer

élantec.

The EL5128 integrates two V_{COM} amplifiers with a single gamma reference buffer. Operating on supplies ranging from 5V to 15V, while consuming only 2.0mA, the EL5128 has a bandwidth of 12MHz (-3dB) and provides common mode input ability beyond the supply rails, as well as rail-to-rail output capability. This enables the amplifier to offer maximum dynamic range at any supply voltage. The EL5128 also features fast slewing and settling times, as well as a high output drive capability of 30mA (sink and source).

The EL5128 is targeted at TFT-LCD applications, including notebook panels, monitors, and LCD-TVs. It is available in the 10-pin MSOP package and is specified for operation over the -40°C to +85°C temperature range.

Pinout

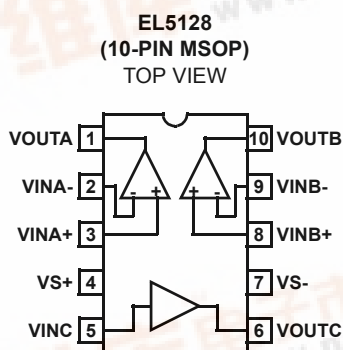

Features

- Dual V_{COM} amplifier
- Single gamma reference buffer
- 12MHz -3dB bandwidth
- Supply voltage = 4.5V to 16.5V
- Low supply current = 2.0mA
- High slew rate = 10V/ μ s
- Unity-gain stable
- Beyond the rails input capability
- Rail-to-rail output swing
- Ultra-small package
- Pb-free available

Applications

- TFT-LCD drive circuits
- Notebook displays
- LCD desktop monitors
- LCD-TVs

Ordering Information

PART NUMBER	PACKAGE	TAPE & REEL	PKG. DWG. #
EL5128CY	10-Pin MSOP	-	MDP0043
EL5128CY-T7	10-Pin MSOP	7"	MDP0043
EL5128CY-T13	10-Pin MSOP	13"	MDP0043
EL5128CZY (See Note)	10-Pin MSOP (Pb-free)	-	MDP0043
EL5128CZY-T7 (See Note)	10-Pin MSOP (Pb-free)	7"	MDP0043
EL5128CZY-T13 (See Note)	10-Pin MSOP (Pb-free)	13"	MDP0043

NOTE: Intersil Pb-free products employ special Pb-free material sets; molding compounds/die attach materials and 100% matte tin plate termination finish, which is compatible with both SnPb and Pb-free soldering operations. Intersil Pb-free products are MSL classified at Pb-free peak reflow temperatures that meet or exceed the Pb-free requirements of IPC/JEDEC J Std-020B.



EL5128

Absolute Maximum Ratings ($T_A = 25^\circ\text{C}$)

Supply Voltage between V_{S+} and V_{S-} +18V	Storage Temperature -65°C to $+150^\circ\text{C}$
Input Voltage $V_{S-} - 0.5\text{V}$, $V_{S+} + 0.5\text{V}$	Ambient Operating Temperature -40°C to $+85^\circ\text{C}$
Maximum Continuous Output Current 30mA	Power Dissipation See Curves
Maximum Die Temperature $+125^\circ\text{C}$	

CAUTION: Stresses above those listed in "Absolute Maximum Ratings" may cause permanent damage to the device. This is a stress only rating and operation of the device at these or any other conditions above those indicated in the operational sections of this specification is not implied.

IMPORTANT NOTE: All parameters having Min/Max specifications are guaranteed. Typ values are for information purposes only. Unless otherwise noted, all tests are at the specified temperature and are pulsed tests, therefore: $T_J = T_C = T_A$

Electrical Specifications $V_{S+} = +5\text{V}$, $V_{S-} = -5\text{V}$, $R_L = 10\text{k}\Omega$ and $C_L = 10\text{pF}$ to 0V , $T_A = 25^\circ\text{C}$ unless otherwise specified

PARAMETER	DESCRIPTION	CONDITION	MIN	TYP	MAX	UNIT
INPUT CHARACTERISTICS						
V_{OS}	Input Offset Voltage	$V_{CM} = 0\text{V}$		2	12	mV
TCV_{OS}	Average Offset Voltage Drift	(Note 1)		5		$\mu\text{V}/^\circ\text{C}$
I_B	Input Bias Current	$V_{CM} = 0\text{V}$		2	50	nA
R_{IN}	Input Impedance			1		$\text{G}\Omega$
C_{IN}	Input Capacitance			1.35		pF
CMIR	Common-Mode Input Range	(V_{COM} amps)	-5.5		+5.5	V
CMRR	Common-Mode Rejection Ratio	(V_{COM} amps) for V_{IN} from -5.5V to $+5.5\text{V}$	50	70		dB
A_{VOL}	Open-Loop Gain	$-4.5\text{V} \leq V_{OUT} \leq +4.5\text{V}$ (V_{COM} amps)	75	95		dB
AV	Voltage Gain	$-4.5\text{V} \leq V_{OUT} \leq +4.5\text{V}$	0.995		1.005	V/V
OUTPUT CHARACTERISTICS						
V_{OL}	Output Swing Low	$I_L = -5\text{mA}$		-4.92	-4.85	V
V_{OH}	Output Swing High	$I_L = 5\text{mA}$	4.85	4.92		V
I_{SC}	Short Circuit Current			± 120		mA
I_{OUT}	Output Current			± 30		mA
POWER SUPPLY PERFORMANCE						
PSRR	Power Supply Rejection Ratio	V_S is moved from $\pm 2.25\text{V}$ to $\pm 7.75\text{V}$	60	80		dB
I_S	Supply Current (per amplifier)	No load		660	1000	μA
DYNAMIC PERFORMANCE						
SR	Slew Rate (Note 2)	$-4.0\text{V} \leq V_{OUT} \leq +4.0\text{V}$, 20% to 80%		10		$\text{V}/\mu\text{s}$
t_S	Settling to $\pm 0.1\%$ ($A_V = +1$)	($A_V = +1$), $V_O = 2\text{V}$ step		500		ns
BW	-3dB Bandwidth	$R_L = 10\text{k}\Omega$, $C_L = 10\text{pF}$		12		MHz
GBWP	Gain-Bandwidth Product	$R_L = 10\text{k}\Omega$, $C_L = 10\text{pF}$ (V_{COM} amps)		8		MHz
PM	Phase Margin	$R_L = 10\text{k}\Omega$, $C_L = 10\text{pF}$ (V_{COM} amps)		50		$^\circ$
CS	Channel Separation	$f = 5\text{MHz}$		75		dB

NOTES:

1. Measured over operating temperature range.
2. Slew rate is measured on rising and falling edges.

EL5128

Electrical Specifications $V_{S+} = +5V$, $V_{S-} = 0V$, $R_L = 10k\Omega$ and $C_L = 10pF$ to 2.5V, $T_A = 25^\circ C$ unless otherwise specified

PARAMETER	DESCRIPTION	CONDITION	MIN	TYP	MAX	UNIT
INPUT CHARACTERISTICS						
V_{OS}	Input Offset Voltage	$V_{CM} = 2.5V$		2	10	mV
TCV_{OS}	Average Offset Voltage Drift	(Note 1)		5		$\mu V/^\circ C$
I_B	Input Bias Current	$V_{CM} = 2.5V$		2	50	nA
R_{IN}	Input Impedance			1		$G\Omega$
C_{IN}	Input Capacitance			1.35		pF
CMIR	Common-Mode Input Range		-0.5		+5.5	V
CMRR	Common-Mode Rejection Ratio	for V_{IN} from -0.5V to +5.5V	45	66		dB
A_{VOL}	Open-Loop Gain	$0.5V \leq V_{OUT} \leq 4.5V$	75	95		dB
A_V	Voltage Gain	$0.5V \leq V_{OUT} \leq 4.5V$	0.995		1.005	V/V
OUTPUT CHARACTERISTICS						
V_{OL}	Output Swing Low	$I_L = -5mA$		80	150	mV
V_{OH}	Output Swing High	$I_L = +5mA$	4.85	4.92		V
I_{SC}	Short Circuit Current			± 120		mA
I_{OUT}	Output Current			± 30		mA
POWER SUPPLY PERFORMANCE						
PSRR	Power Supply Rejection Ratio	V_S is moved from 4.5V to 15.5V	60	80		dB
I_S	Supply Current (per amplifier)	No load		660	1000	μA
DYNAMIC PERFORMANCE						
SR	Slew Rate (Note 2)	$1V \leq V_{OUT} \leq 4V$, 20% to 80%		10		$V/\mu s$
t_S	Settling to +0.1% ($A_V = +1$)	($A_V = +1$), $V_O = 2V$ step		500		ns
BW	-3dB Bandwidth	$R_L = 10k\Omega$, $C_L = 10pF$		12		MHz
GBWP	Gain-Bandwidth Product	$R_L = 10k\Omega$, $C_L = 10pF$		8		MHz
PM	Phase Margin	$R_L = 10k\Omega$, $C_L = 10pF$		50		$^\circ$
CS	Channel Separation	$f = 5MHz$		75		dB

NOTES:

1. Measured over operating temperature range.
2. Slew rate is measured on rising and falling edges.

EL5128

Electrical Specifications $V_{S+} = +15V$, $V_{S-} = 0V$, $R_L = 10k\Omega$ and $C_L = 10pF$ to 7.5V, $T_A = 25^\circ C$ unless otherwise specified

PARAMETER	DESCRIPTION	CONDITION	MIN	TYP	MAX	UNIT
INPUT CHARACTERISTICS						
V_{OS}	Input Offset Voltage	$V_{CM} = 7.5V$		2	14	mV
TCV_{OS}	Average Offset Voltage Drift	(Note 1)		5		$\mu V/^\circ C$
I_B	Input Bias Current	$V_{CM} = 7.5V$		2	50	nA
R_{IN}	Input Impedance			1		$G\Omega$
C_{IN}	Input Capacitance			1.35		pF
CMIR	Common-Mode Input Range		-0.5		+15.5	V
CMRR	Common-Mode Rejection Ratio	for V_{IN} from -0.5V to +15.5V	53	72		dB
A_{VOL}	Open-Loop Gain	$0.5V \leq V_{OUT} \leq 14.5V$	75	95		dB
A_V	Voltage Gain	$0.5V \leq V_{OUT} \leq 14.5V$	0.995		1.005	V/V
OUTPUT CHARACTERISTICS						
V_{OL}	Output Swing Low	$I_L = -5mA$		80	150	mV
V_{OH}	Output Swing High	$I_L = +5mA$	14.85	14.92		V
I_{SC}	Short Circuit Current			± 120		mA
I_{OUT}	Output Current			± 30		mA
POWER SUPPLY PERFORMANCE						
PSRR	Power Supply Rejection Ratio	V_S is moved from 4.5V to 15.5V	60	80		dB
I_S	Supply Current (per amplifier)	No load		660	1000	μA
DYNAMIC PERFORMANCE						
SR	Slew Rate (Note 2)	$1V \leq V_{OUT} \leq 14V$, 20% to 80%		10		$V/\mu s$
t_S	Settling to +0.1% ($A_V = +1$)	($A_V = +1$), $V_O = 2V$ step		500		ns
BW	-3dB Bandwidth	$R_L = 10k\Omega$, $C_L = 10pF$		12		MHz
GBWP	Gain-Bandwidth Product	$R_L = 10k\Omega$, $C_L = 10pF$		8		MHz
PM	Phase Margin	$R_L = 10k\Omega$, $C_L = 10pF$		50		$^\circ$
CS	Channel Separation	$f = 5MHz$		75		dB

NOTES:

1. Measured over operating temperature range.
2. Slew rate is measured on rising and falling edges.

Typical Performance Curves

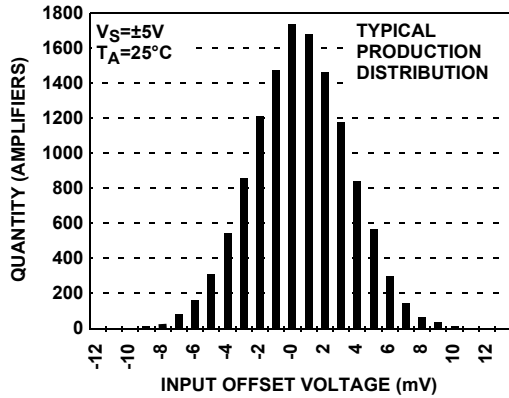

FIGURE 1. INPUT OFFSET VOLTAGE DISTRIBUTION

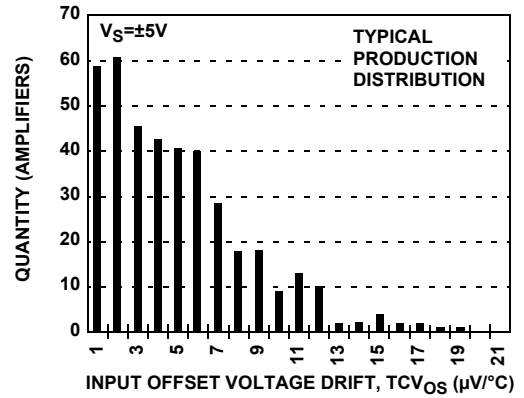

FIGURE 2. INPUT OFFSET VOLTAGE DRIFT

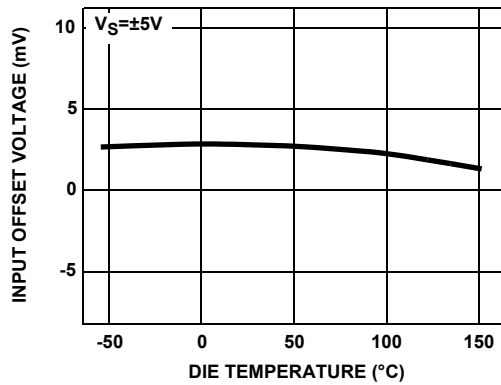

FIGURE 3. INPUT OFFSET VOLTAGE vs TEMPERATURE

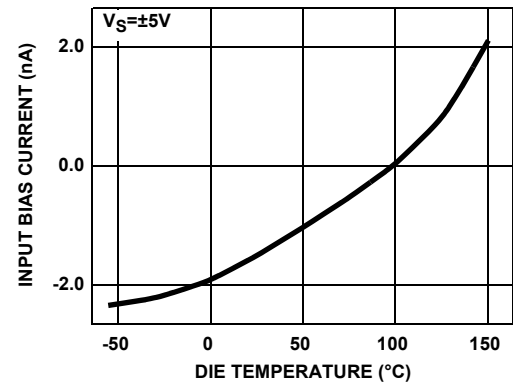

FIGURE 4. INPUT BIAS CURRENT vs TEMPERATURE

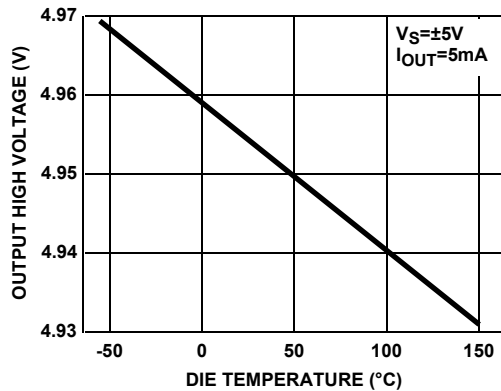

FIGURE 5. OUTPUT HIGH VOLTAGE vs TEMPERATURE

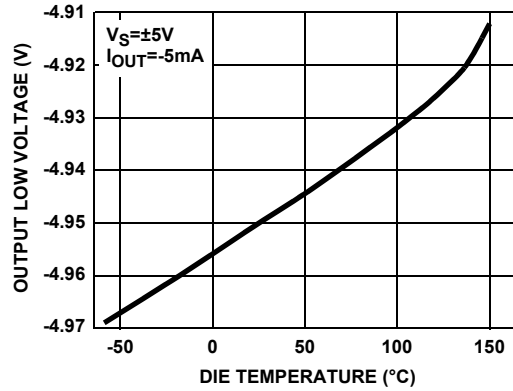

FIGURE 6. OUTPUT LOW VOLTAGE vs TEMPERATURE

Typical Performance Curves (Continued)

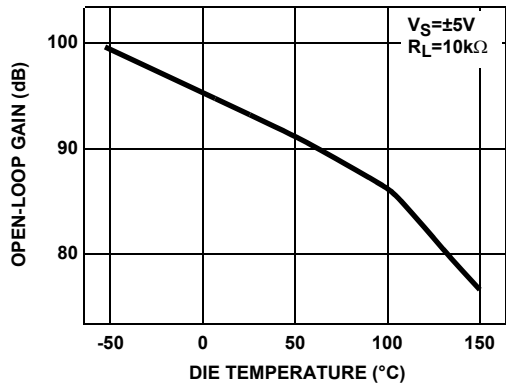

FIGURE 7. OPEN-LOOP GAIN vs TEMPERATURE

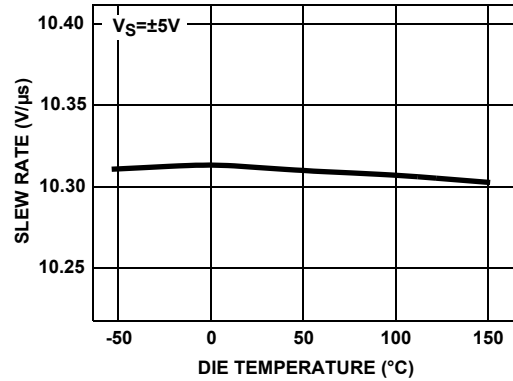

FIGURE 8. SLEW RATE vs TEMPERATURE

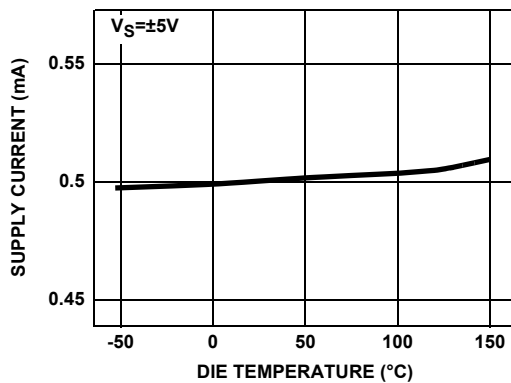

FIGURE 9. SUPPLY CURRENT PER AMPLIFIER vs TEMPERATURE

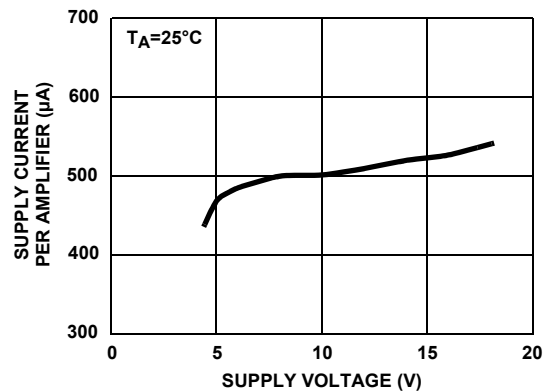

FIGURE 10. SUPPLY CURRENT PER AMPLIFIER vs SUPPLY VOLTAGE

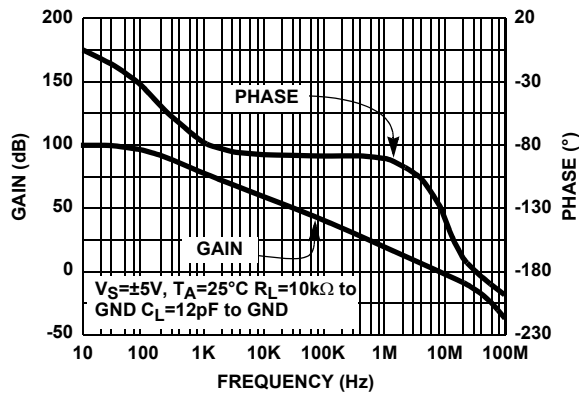

FIGURE 11. OPEN LOOP GAIN AND PHASE vs FREQUENCY

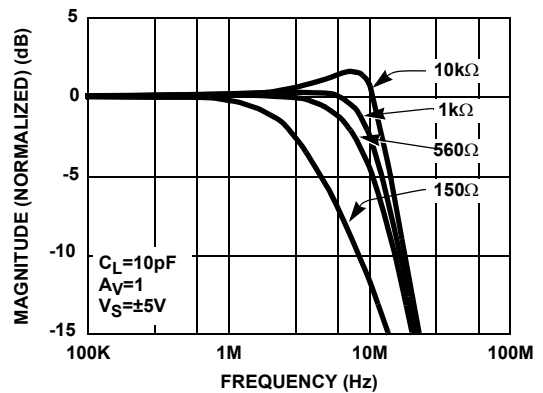

FIGURE 12. FREQUENCY RESPONSE FOR VARIOUS R_L

Typical Performance Curves (Continued)

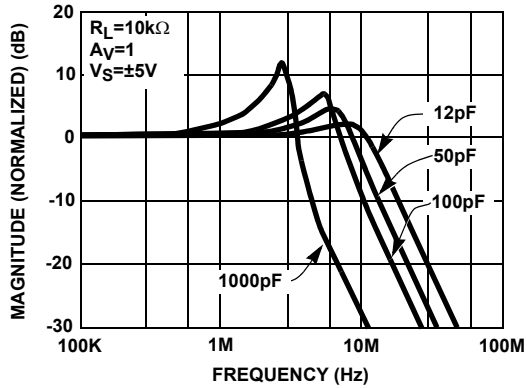

FIGURE 13. FREQUENCY RESPONSE FOR VARIOUS C_L

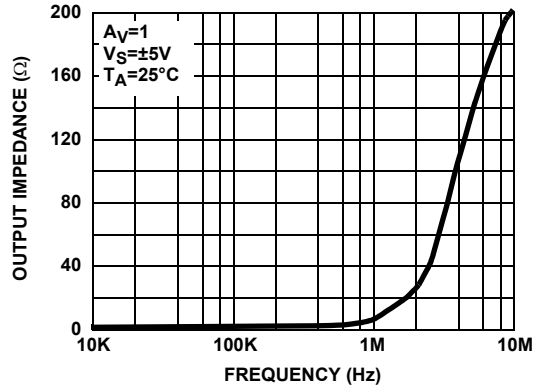

FIGURE 14. CLOSED LOOP OUTPUT IMPEDANCE vs FREQUENCY

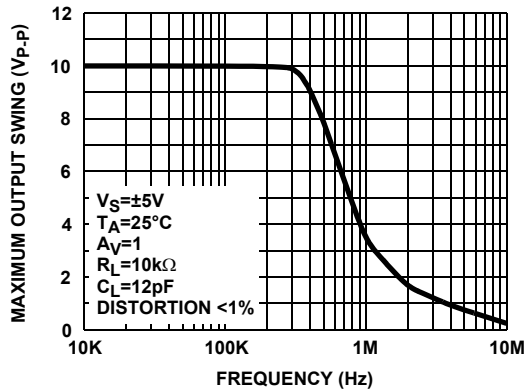

FIGURE 15. MAXIMUM OUTPUT SWING vs FREQUENCY

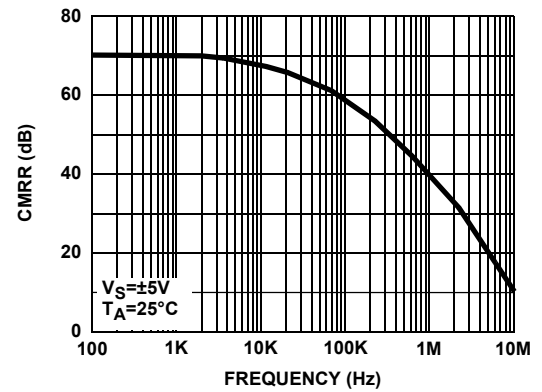

FIGURE 16. CMRR vs FREQUENCY

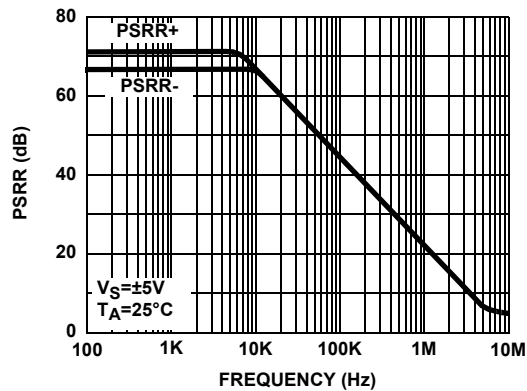

FIGURE 17. PSRR vs FREQUENCY

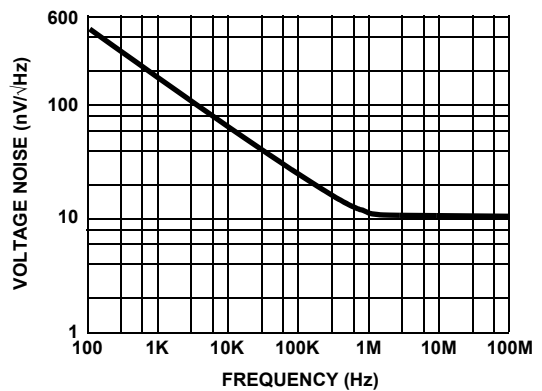

FIGURE 18. INPUT VOLTAGE NOISE SPECTRAL DENSITY vs FREQUENCY

Typical Performance Curves (Continued)

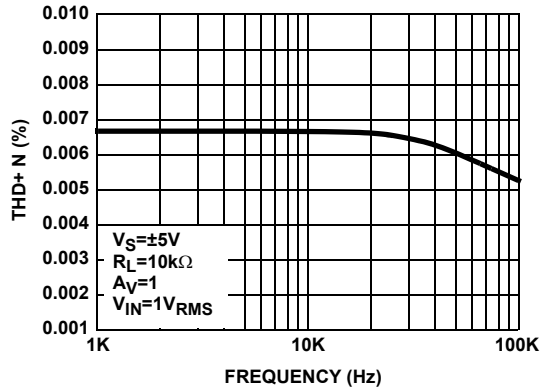

FIGURE 19. TOTAL HARMONIC DISTORTION + NOISE vs FREQUENCY

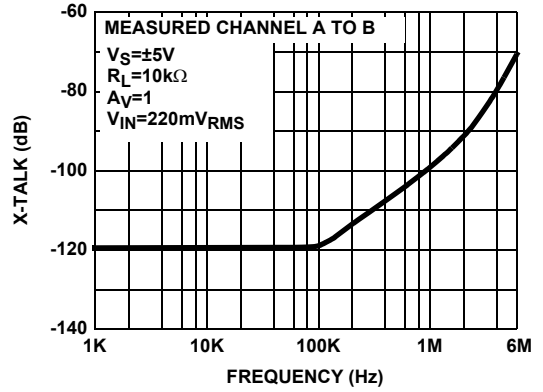

FIGURE 20. CHANNEL SEPARATION vs FREQUENCY RESPONSE

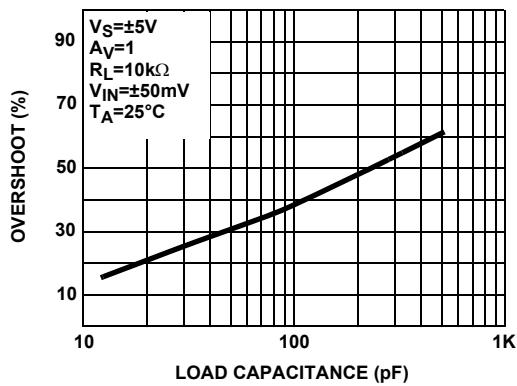

FIGURE 21. SMALL-SIGNAL OVERSHOOT vs LOAD CAPACITANCE

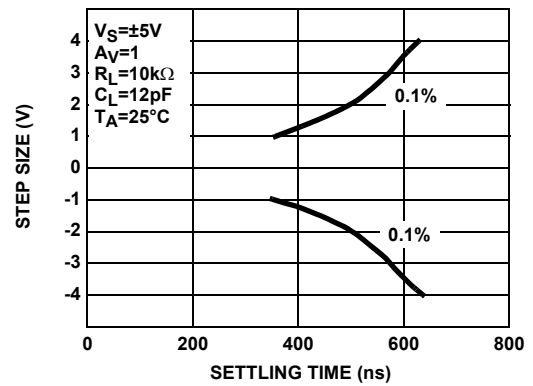

FIGURE 22. SETTLING TIME vs STEP SIZE

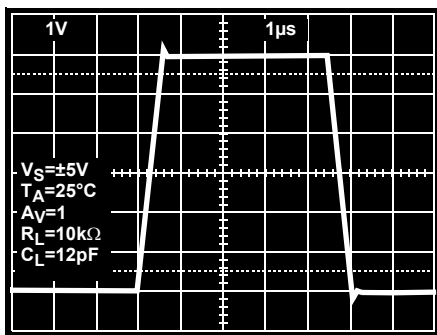

FIGURE 23. LARGE SIGNAL TRANSIENT RESPONSE

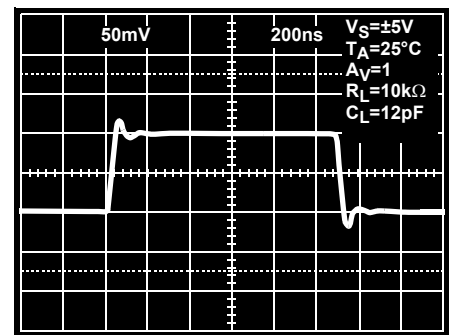

FIGURE 24. SMALL SIGNAL TRANSIENT RESPONSE

EL5128

Pin Descriptions

PIN NUMBER	PIN NAME	PIN FUNCTION	EQUIVALENT CIRCUIT
1	VOUTA	Amplifier A Output	<p style="text-align: center;">CIRCUIT 1</p>
2	VINA-	Amplifier A Inverting Input	<p style="text-align: center;">CIRCUIT 2</p>
3	VINA+	Amplifier A Non-Inverting Input	(Reference Circuit 2)
4	VS+	Positive Power Supply	
5	VINC	Amplifier C	(Reference Circuit 2)
6	VOUTC	Amplifier C Output	(Reference Circuit 2)
7	VS-	Negative Power Supply	
8	VINB+	Amplifier B Non-Inverting Input	(Reference Circuit 2)
9	VINB-	Amplifier B Inverting Input	(Reference Circuit 2)
10	VOUTB	Amplifier B Output	(Reference Circuit 1)

Applications Information

Product Description

The EL5128 voltage feedback amplifier/buffer combination is fabricated using a high voltage CMOS process. It exhibits rail-to-rail input and output capability, it is unity gain stable, and has low power consumption (500µA per amplifier). These features make the EL5128 ideal for a wide range of general-purpose applications. Connected in voltage follower mode and driving a load of 10kΩ and 12pF, the EL5128 has a -3dB bandwidth of 12MHz while maintaining a 10V/µs slew rate.

Operating Voltage, Input, and Output

The EL5128 is specified with a single nominal supply voltage from 5V to 15V or a split supply with its total range from 5V to 15V. Correct operation is guaranteed for a supply range of 4.5V to 16.5V. Most EL5128 specifications are stable over both the full supply range and operating temperatures of -40°C to +85°C. Parameter variations with operating voltage and/or temperature are shown in the typical performance curves.

The input common-mode voltage range of the amplifiers extends 500mV beyond the supply rails. The output swings of the EL5128 typically extend to within 80mV of positive and negative supply rails with load currents of 5mA. Decreasing load currents will extend the output voltage range even closer to the supply rails. Figure 25 shows the input and output waveforms for the device in the unity-gain configuration. Operation is from ±5V supply with a 10kΩ load connected to GND. The input is a 10V_{P-P} sinusoid. The output voltage is approximately 9.985V_{P-P}.

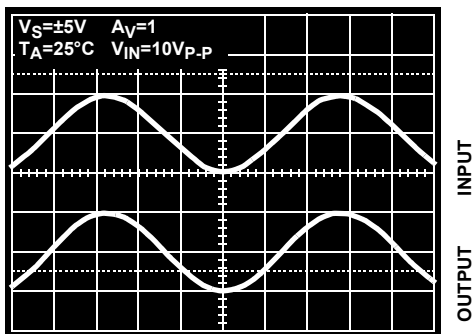

FIGURE 25. OPERATION WITH RAIL-TO-RAIL INPUT AND OUTPUT

Output Phase Reversal

The EL5128 is immune to phase reversal as long as the input voltage is limited from (V_{S-}) -0.5V to (V_{S+}) +0.5V. Figure 26 shows a photo of the output of the device with the input voltage driven beyond the supply rails. Although the device's output will not change phase, the input's over-voltage should be avoided. If an input voltage exceeds supply voltage by more than 0.6V, electrostatic protection

diodes placed in the input stage of the device begin to conduct and over-voltage damage could occur.

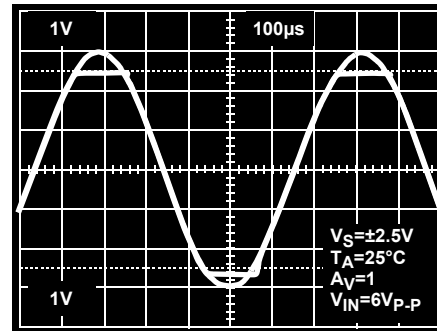

FIGURE 26. OPERATION WITH BEYOND-THE-RAILS INPUT

Short Circuit Current Limit

The EL5128 will limit the short circuit current to ±120mA if the output is directly shorted to the positive or the negative supply. If an output is shorted indefinitely, the power dissipation could easily increase such that the device may be damaged. Maximum reliability is maintained if the output continuous current never exceeds ±30mA. This limit is set by the design of the internal metal interconnects.

Driving Capacitive Loads

The EL5128 can drive a wide range of capacitive loads. As load capacitance increases, however, the -3dB bandwidth of the device will decrease and the peaking increase. The amplifiers drive 10pF loads in parallel with 10kΩ with just 1.5dB of peaking, and 100pF with 6.4dB of peaking. If less peaking is desired in these applications, a small series resistor (usually between 5Ω and 50Ω) can be placed in series with the output. However, this will obviously reduce the gain slightly. Another method of reducing peaking is to add a “snubber” circuit at the output. A snubber is a shunt load consisting of a resistor in series with a capacitor. Values of 150Ω and 10nF are typical. The advantage of a snubber is that it does not draw any DC load current or reduce the gain.

Power Dissipation

With the high-output drive capability of the EL5128 amplifier, it is possible to exceed the 125°C “absolute-maximum junction temperature” under certain load current conditions. Therefore, it is important to calculate the maximum junction temperature for the application to determine if load conditions need to be modified for the amplifier to remain in the safe operating area.

The maximum power dissipation allowed in a package is determined according to:

$$P_{D\text{MAX}} = \frac{T_{J\text{MAX}} - T_{A\text{MAX}}}{\Theta_{JA}}$$

where:

- T_{JMAX} = Maximum junction temperature
- T_{AMAX} = Maximum ambient temperature
- θ_{JA} = Thermal resistance of the package
- P_{DMAX} = Maximum power dissipation in the package

The maximum power dissipation actually produced by an IC is the total quiescent supply current times the total power supply voltage, plus the power in the IC due to the loads, or:

$$P_{DMAX} = \sum i \times [V_S \times I_{SMAX} + (V_S^+ - V_{OUT}^i) \times I_{LOAD}^i]$$

when sourcing, and:

$$P_{DMAX} = \sum i \times [V_S \times I_{SMAX} + (V_{OUT}^i - V_S^-) \times I_{LOAD}^i]$$

when sinking.

where:

- V_S = Total supply voltage
- I_{SMAX} = Maximum supply current per amplifier
- V_{OUT}^i = Maximum output voltage of the application
- I_{LOAD}^i = Load current

If we set the two P_{DMAX} equations equal to each other, we can solve for R_{LOAD}^i to avoid device overheat. Figures 27 and 28 provide a convenient way to see if the device will overheat. The maximum safe power dissipation can be found graphically, based on the package type and the ambient temperature. By using the previous equation, it is a simple matter to see if P_{DMAX} exceeds the device's power derating curves. To ensure proper operation, it is important to observe the recommended derating curves in Figures 27 and 28.

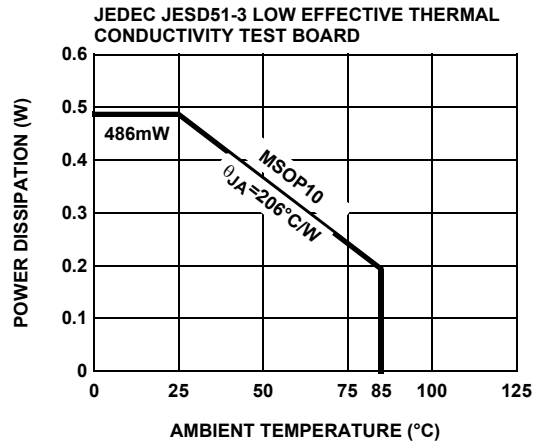

FIGURE 27. PACKAGE POWER DISSIPATION vs AMBIENT TEMPERATURE

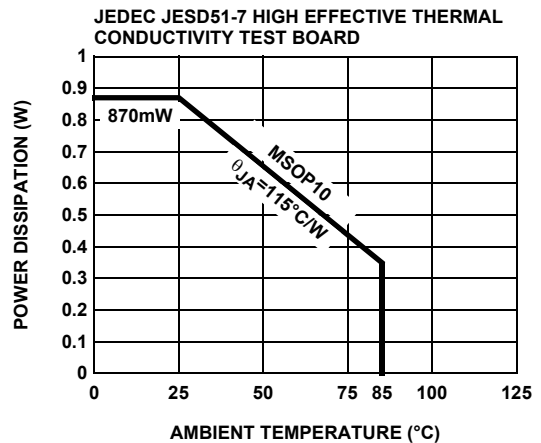

FIGURE 28. PACKAGE POWER DISSIPATION vs AMBIENT TEMPERATURE

Power Supply Bypassing and Printed Circuit Board Layout

The EL5128 can provide gain at high frequency. As with any high-frequency device, good printed circuit board layout is necessary for optimum performance. Ground plane construction is highly recommended, lead lengths should be as short as possible and the power supply pins must be well bypassed to reduce the risk of oscillation. For normal single supply operation, where the V_{S-} pin is connected to ground, a 0.1µF ceramic capacitor should be placed from V_{S+} to pin to V_{S-} pin. A 4.7µF tantalum capacitor should then be connected in parallel, placed in the region of the amplifier. One 4.7µF capacitor may be used for multiple devices. This same capacitor combination should be placed at each supply pin to ground if split supplies are to be used.

All Intersil U.S. products are manufactured, assembled and tested utilizing ISO9000 quality systems. Intersil Corporation's quality certifications can be viewed at www.intersil.com/design/quality

Intersil products are sold by description only. Intersil Corporation reserves the right to make changes in circuit design, software and/or specifications at any time without notice. Accordingly, the reader is cautioned to verify that data sheets are current before placing orders. Information furnished by Intersil is believed to be accurate and reliable. However, no responsibility is assumed by Intersil or its subsidiaries for its use; nor for any infringements of patents or other rights of third parties which may result from its use. No license is granted by implication or otherwise under any patent or patent rights of Intersil or its subsidiaries.