

## 500MHz Low Noise Amplifiers

The EL5130 and EL5131 are ultra-low voltage noise, high speed voltage feedback amplifiers that are ideal for applications requiring low voltage noise, including communications and imaging. These devices offer extremely low power consumption for exceptional noise performance. Stable at gains as low as 5, these devices offer 100mA of drive performance. Not only do these devices find perfect application in high gain applications, they maintain their performance down to lower gain settings.

These amplifiers are available in small package options (SOT-23) as well as the industry-standard SO packages. All parts are specified for operation over the -40°C to +85°C temperature range.

### Ordering Information

PART NUMBER	PACKAGE	TAPE & REEL	PKG. DWG. #
EL5130IS	8-Pin SO	-	MDP0027
EL5130IS-T7	8-Pin SO	7"	MDP0027
EL5130IS-T13	8-Pin SO	13"	MDP0027
EL5130ISZ (See Note)	8-Pin SO (Pb-free)	-	MDP0027
EL5130ISZ-T7 (See Note)	8-Pin SO (Pb-free)	7"	MDP0027
EL5130ISZ-T13 (See Note)	8-Pin SO (Pb-free)	13"	MDP0027
EL5131IW-T7	5-Pin SOT-23	7" (3K pcs)	MDP0038
EL5131IW-T7A	5-Pin SOT-23	7" (250 pcs)	MDP0038
EL5131IWZ-T7 (See Note)	5-Pin SOT-23 (Pb-free)	7" (3K pcs)	MDP0038
EL5131IWZ-T7A (See Note)	5-Pin SOT-23 (Pb-free)	7" (250 pcs)	MDP0038

NOTE: Intersil Pb-free products employ special Pb-free material sets; molding compounds/die attach materials and 100% matte tin plate termination finish, which are RoHS compliant and compatible with both SnPb and Pb-free soldering operations. Intersil Pb-free products are MSL classified at Pb-free peak reflow temperatures that meet or exceed the Pb-free requirements of IPC/JEDEC J STD-020C.

### Features

- 500MHz -3dB bandwidth
- Ultra low noise 1.8nV/√Hz
- 350V/μs slew rate
- Low supply current = 4mA
- Single supplies from 5V to 12V
- Dual supplies from ±2.5V to ±5V
- Fast disable on the EL5130
- Low cost
- Pb-Free Available (RoHS Compliant)

### Applications

- Imaging
- Instrumentation
- Communications devices

### Pinouts

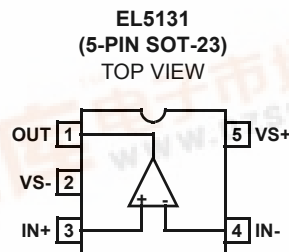
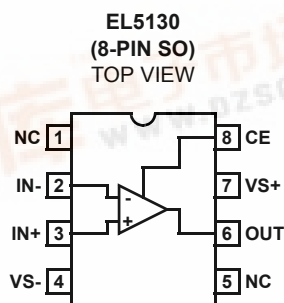

## EL5130, EL5131

### Absolute Maximum Ratings (T<sub>A</sub> = 25°C)

Supply Voltage from V <sub>S+</sub> to V <sub>S-</sub> . . . . . 13.2V	Storage Temperature . . . . . -65°C to +125°C
I <sub>IN-</sub> , I <sub>IN+</sub> , CE . . . . . ±5mA	Ambient Operating Temperature . . . . . -40°C to +85°C
Continuous Output Current . . . . . 100mA	Operating Junction Temperature . . . . . +125°C
Power Dissipation . . . . . See Curves	

*CAUTION: Stresses above those listed in "Absolute Maximum Ratings" may cause permanent damage to the device. This is a stress only rating and operation of the device at these or any other conditions above those indicated in the operational sections of this specification is not implied.*

*IMPORTANT NOTE: All parameters having Min/Max specifications are guaranteed. Typical values are for information purposes only. Unless otherwise noted, all tests are at the specified temperature and are pulsed tests, therefore: T<sub>J</sub> = T<sub>C</sub> = T<sub>A</sub>*

### Electrical Specifications V<sub>S+</sub> = +5V, V<sub>S-</sub> = -5V, R<sub>L</sub> = 150Ω, R<sub>F</sub> = 900Ω, R<sub>G</sub> = 100Ω, T<sub>A</sub> = 25°C, unless otherwise specified.

PARAMETER	DESCRIPTION	CONDITIONS	MIN	TYP	MAX	UNIT
V <sub>OS</sub>	Offset Voltage		-0.9	0.2	0.9	mV
T <sub>C</sub> V <sub>OS</sub>	Offset Voltage Temperature Coefficient	Measured from T <sub>MIN</sub> to T <sub>MAX</sub>		0.8		μV/°C
I <sub>B</sub>	Input Bias Current	V <sub>IN</sub> = 0V	1.5	2.27	3.3	μA
I <sub>OS</sub>	Input Offset Current	V <sub>IN</sub> = 0V	-500	100	500	nA
T <sub>C</sub> I <sub>OS</sub>	Input Bias Current Temperature Coefficient	Measured from T <sub>MIN</sub> to T <sub>MAX</sub>		-3		nA/°C
PSRR	Power Supply Rejection Ratio	V <sub>S</sub> = ±4.75V to ±5.25V	75	90		dB
CMRR	Common Mode Rejection Ratio	V <sub>IN</sub> = ±3.0V	95	110		dB
CMIR	Common Mode Input Range	Guaranteed by CMRR test	±3	±3.3		V
R <sub>IN</sub>	Input Resistance	Common mode	5	20		MΩ
C <sub>IN</sub>	Input Capacitance			1		pF
I <sub>S</sub>	Supply Current		3.0	3.54	4.1	mA
AVOL	Open Loop Gain	V <sub>OUT</sub> = ±2.5V, R <sub>L</sub> = 1kΩ to GND	10	16		kV/V
V <sub>O</sub>	Output Voltage Swing	R <sub>L</sub> = 1kΩ, R <sub>F</sub> = 900Ω, R <sub>G</sub> = 100Ω	±3.5	±3.8		V
		R <sub>L</sub> = 150Ω	±3.5	±3.3		mV
I <sub>SC</sub>	Short Circuit Current	R <sub>L</sub> = 10Ω	50	100		mA
BW	-3dB Bandwidth	A <sub>V</sub> = +5, R <sub>L</sub> = 1kΩ		500		MHz
BW	±0.1dB Bandwidth	A <sub>V</sub> = +5, R <sub>L</sub> = 1kΩ		60		MHz
GBWP	Gain Bandwidth Product			1500		MHz
PM	Phase Margin	R <sub>L</sub> = 1kΩ, C <sub>L</sub> = 6pF		55		°
SR	Slew Rate	V <sub>S</sub> = ±5V, R <sub>L</sub> = 150Ω, V <sub>OUT</sub> = ±2.5V	225	350		V/μs
t <sub>R</sub> , t <sub>F</sub>	Rise Time, Fall Time	±0.1V <sub>STEP</sub>		TBD		ns
OS	Overshoot	±0.1V <sub>STEP</sub>		TBD		%
t <sub>PD</sub>	Propagation Delay	±0.1V <sub>STEP</sub>		TBD		ns
t <sub>S</sub>	0.01% Settling Time			14		ns
dG	Differential Gain	A <sub>V</sub> = +2, R <sub>F</sub> = 1kΩ		0.01		%
dP	Differential Phase	A <sub>V</sub> = +2, R <sub>F</sub> = 1kΩ		0.01		°
e <sub>N</sub>	Input Noise Voltage	f = 10kHz		1.8		nV/√Hz
i <sub>N</sub>	Input Noise Current	f = 10kHz		1.1		pA/√Hz

Typical Performance Curves

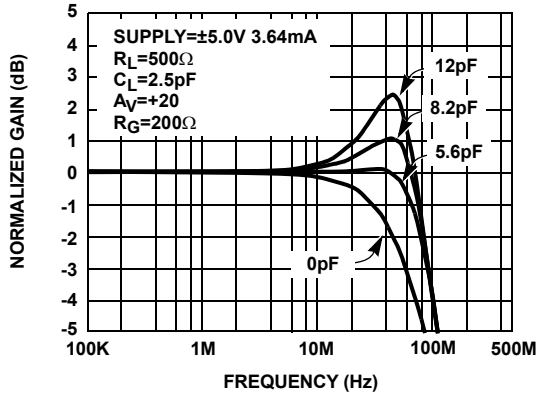

FIGURE 1. GAIN vs FREQUENCY FOR VARIOUS  $C_{IN}$

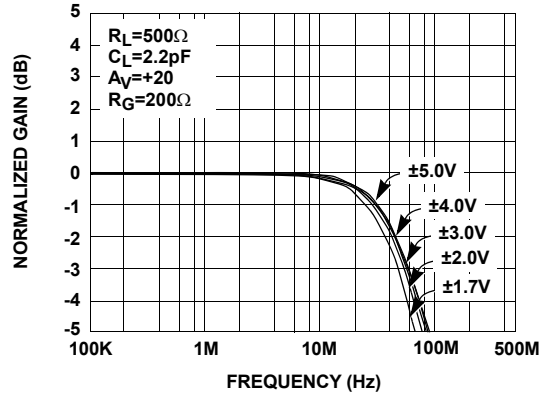

FIGURE 2. GAIN vs FREQUENCY FOR VARIOUS SUPPLY VOLTAGES

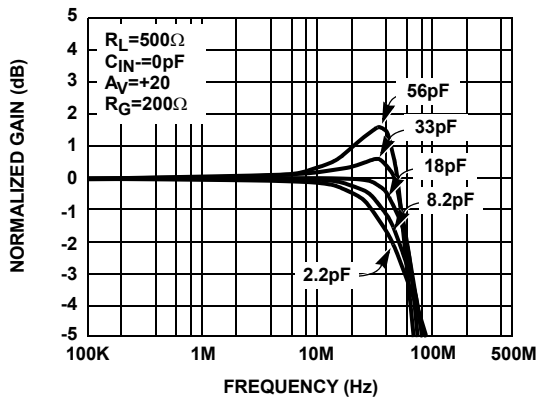

FIGURE 3. GAIN vs FREQUENCY FOR VARIOUS  $C_L$

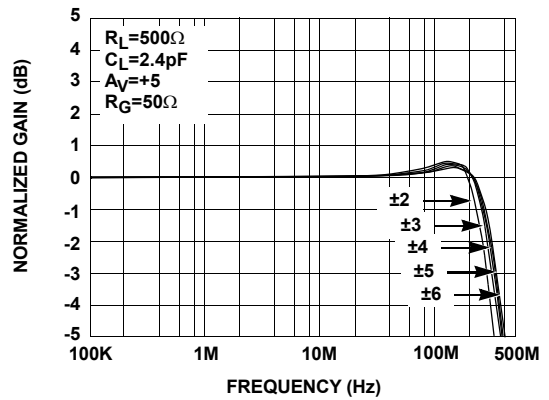

FIGURE 4. FREQUENCY vs GAIN FOR VARIOUS SUPPLY VOLTAGES

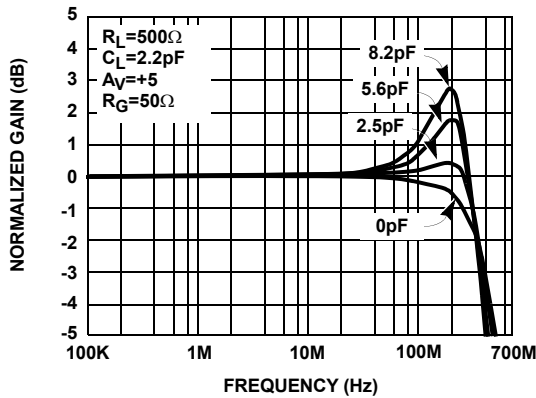

FIGURE 5. GAIN vs FREQUENCY FOR VARIOUS  $C_{IN}$

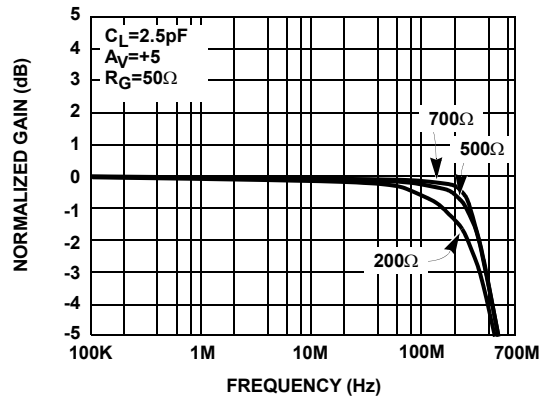

FIGURE 6. GAIN vs FREQUENCY FOR VARIOUS  $R_L$

Typical Performance Curves (Continued)

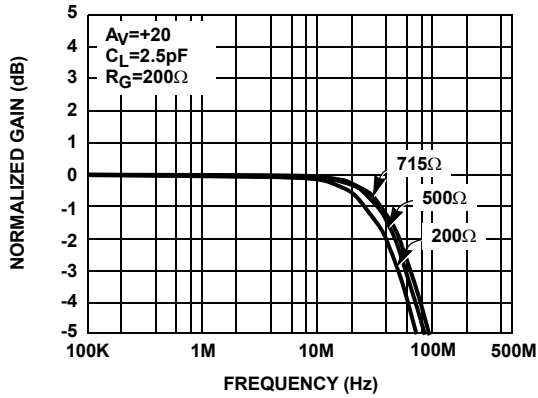

FIGURE 7. GAIN vs FREQUENCY FOR VARIOUS  $R_L$

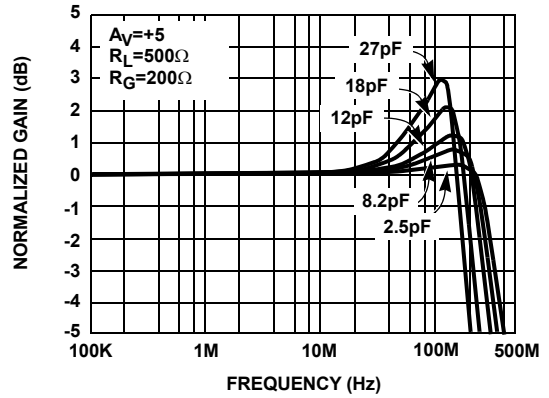

FIGURE 8. FREQUENCY vs GAIN FOR VARIOUS  $C_L$

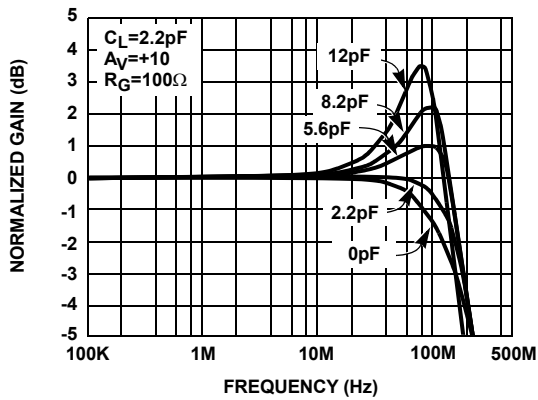

FIGURE 9. GAIN vs FREQUENCY FOR VARIOUS  $C_{IN-}$

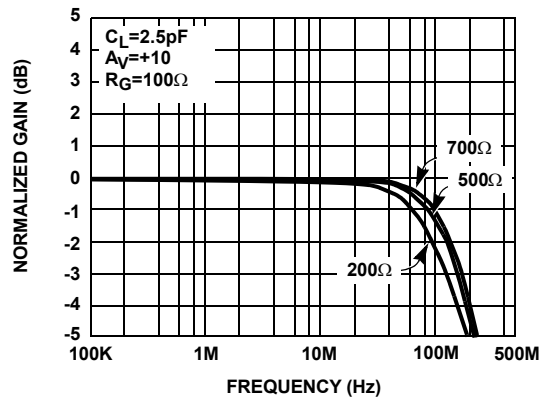

FIGURE 10. GAIN vs FREQUENCY FOR VARIOUS  $R_L$

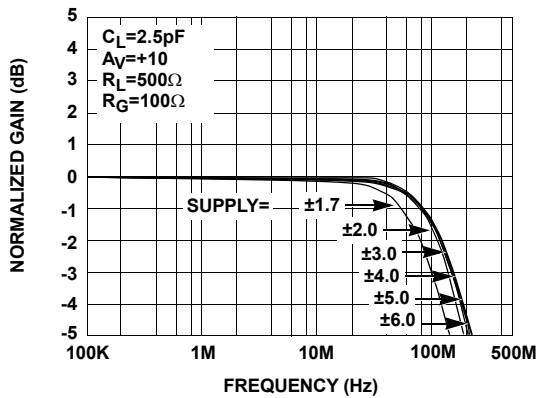

FIGURE 11. GAIN vs FREQUENCY FOR VARIOUS  $V_{S+}$ ,  $V_{S-}$

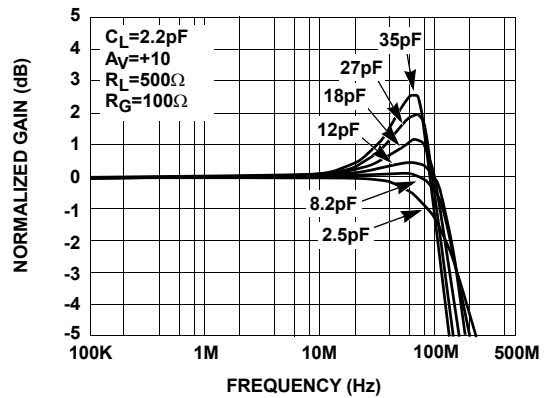

FIGURE 12. GAIN vs FREQUENCY FOR VARIOUS  $R_L$

Typical Performance Curves (Continued)

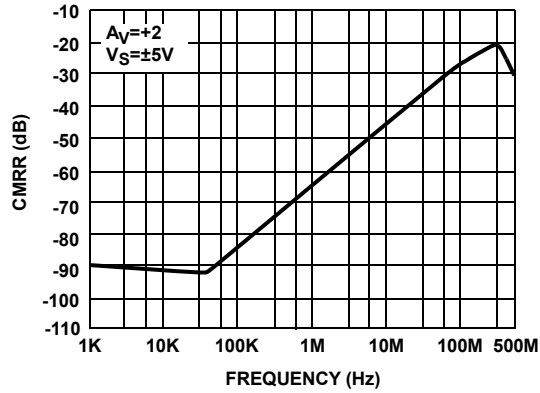

FIGURE 13. CMRR vs FREQUENCY

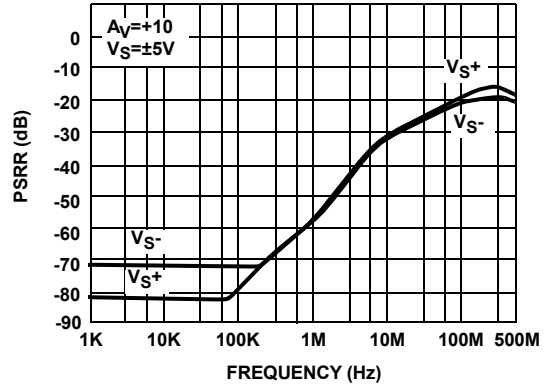

FIGURE 14. PSRR vs FREQUENCY

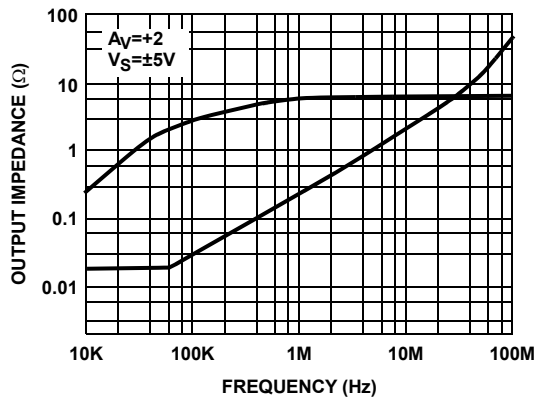

FIGURE 15. OUTPUT IMPEDANCE vs FREQUENCY

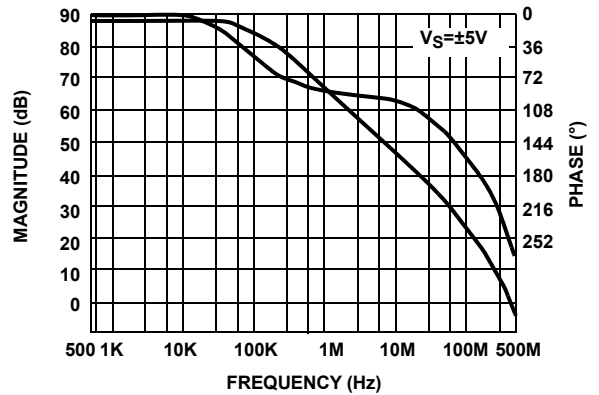

FIGURE 16. OPEN LOOP GAIN AND PHASE vs FREQUENCY

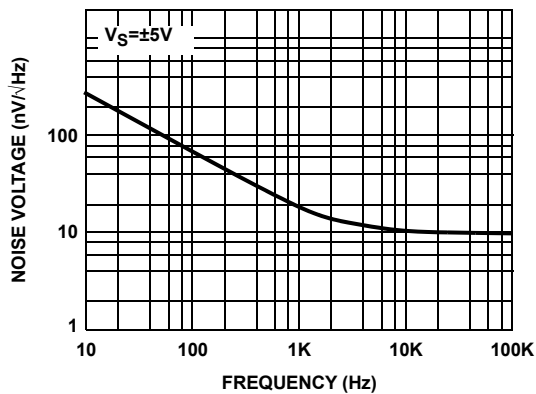

FIGURE 17. EQUIVALENT INPUT VOLTAGE NOISE vs FREQUENCY

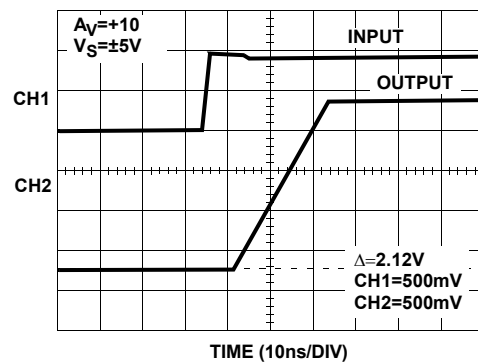

FIGURE 18. LARGE SIGNAL RISE TIME

Typical Performance Curves (Continued)

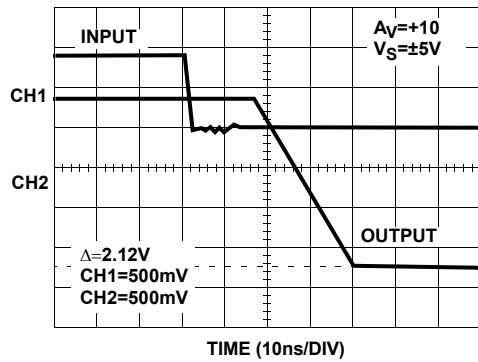

FIGURE 19. LARGE SIGNAL FALL TIME

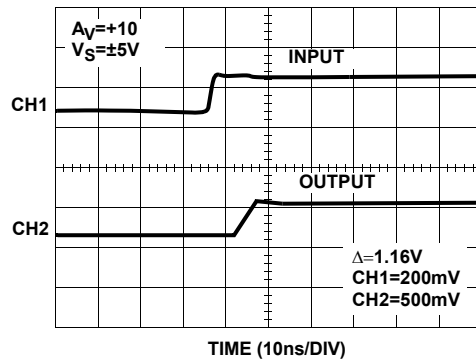

FIGURE 20. SMALL SIGNAL RISE TIME

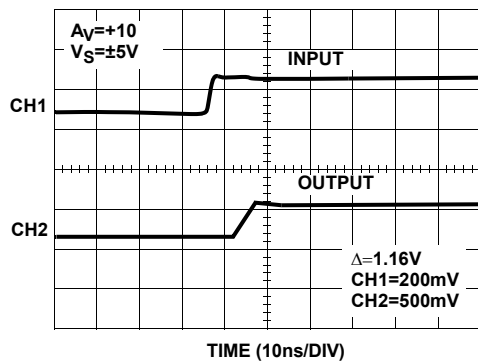

FIGURE 21. SMALL SIGNAL FALL TIME

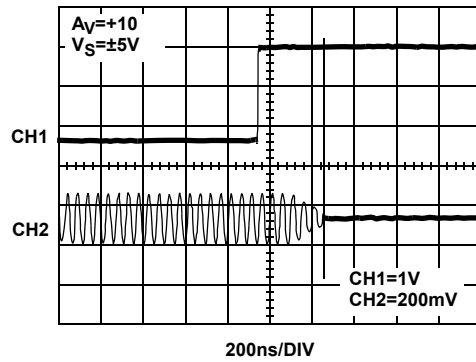

FIGURE 22. TURN OFF TIME

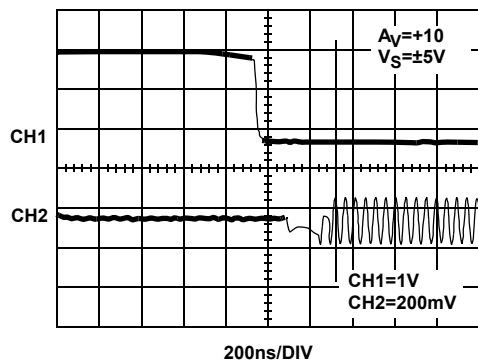

FIGURE 23. TURN ON TIME

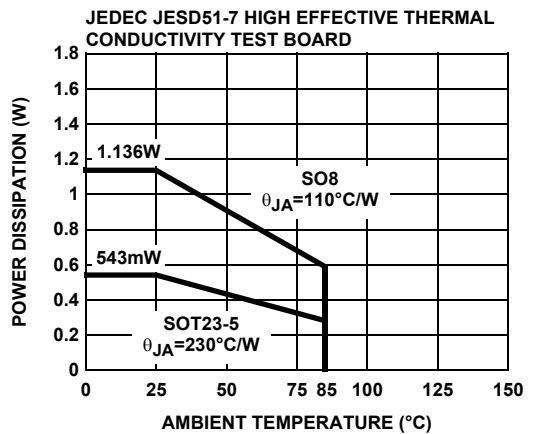

FIGURE 24. PACKAGE POWER DISSIPATION vs AMBIENT TEMPERATURE

# EL5130, EL5131

## Typical Performance Curves (Continued)

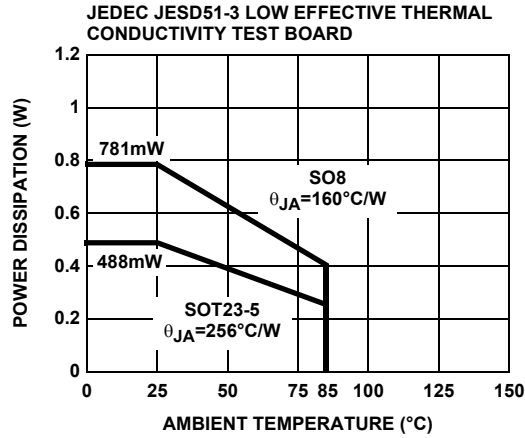

FIGURE 25. PACKAGE POWER DISSIPATION vs AMBIENT TEMPERATURE

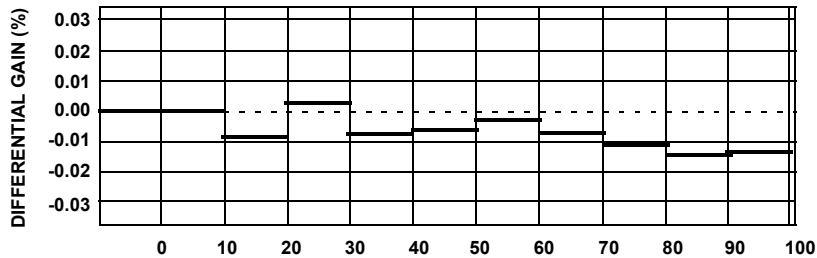

FIGURE 26. DIFFERENTIAL GAIN (%)

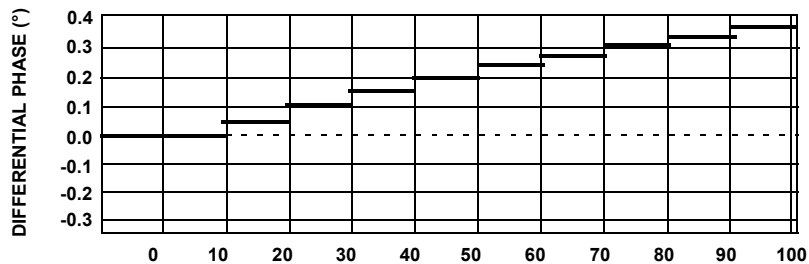

FIGURE 27. DIFFERENTIAL PHASE (°)

All Intersil U.S. products are manufactured, assembled and tested utilizing ISO9000 quality systems. Intersil Corporation's quality certifications can be viewed at [www.intersil.com/design/quality](http://www.intersil.com/design/quality)

*Intersil products are sold by description only. Intersil Corporation reserves the right to make changes in circuit design, software and/or specifications at any time without notice. Accordingly, the reader is cautioned to verify that data sheets are current before placing orders. Information furnished by Intersil is believed to be accurate and reliable. However, no responsibility is assumed by Intersil or its subsidiaries for its use; nor for any infringements of patents or other rights of third parties which may result from its use. No license is granted by implication or otherwise under any patent or patent rights of Intersil or its subsidiaries.*

For information regarding Intersil Corporation and its products, see [www.intersil.com](http://www.intersil.com)