



IPAD™

# EMIF06-10006F1

## 6 LINES EMI FILTER AND ESD PROTECTION

### MAIN PRODUCT CHARACTERISTICS

Where EMI filtering in ESD sensitive equipment is required:

- Mobile phones and communication systems
- Computers, printers and MCU Boards

### DESCRIPTION

The EMIF06-10006F1 is a highly integrated devices designed to suppress EMI/RFI noise in all systems subjected to electromagnetic interferences. The EMIF04 flip-chip packaging means the package size is equal to the die size.

This filter includes an ESD protection circuitry which prevents the device from destruction when subjected to ESD surges up 15kV. This device includes four EMIF filters and 4 separated ESD diodes.

### BENEFITS

- EMI symmetrical (I/O) low-pass filter
- High efficiency in EMI filtering
- Very low PCB space consuming: 2.92mm x 1.29mm
- Very thin package: 0.65 mm
- High efficiency in ESD suppression (IEC61000-4-2 level 4)
- High reliability offered by monolithic integration
- High reducing of parasitic elements through integration and wafer level packaging.

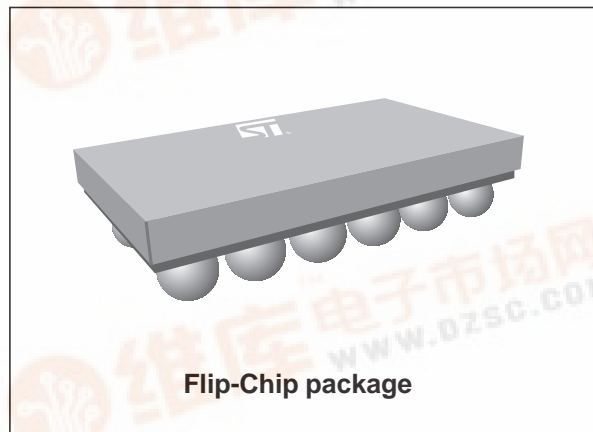
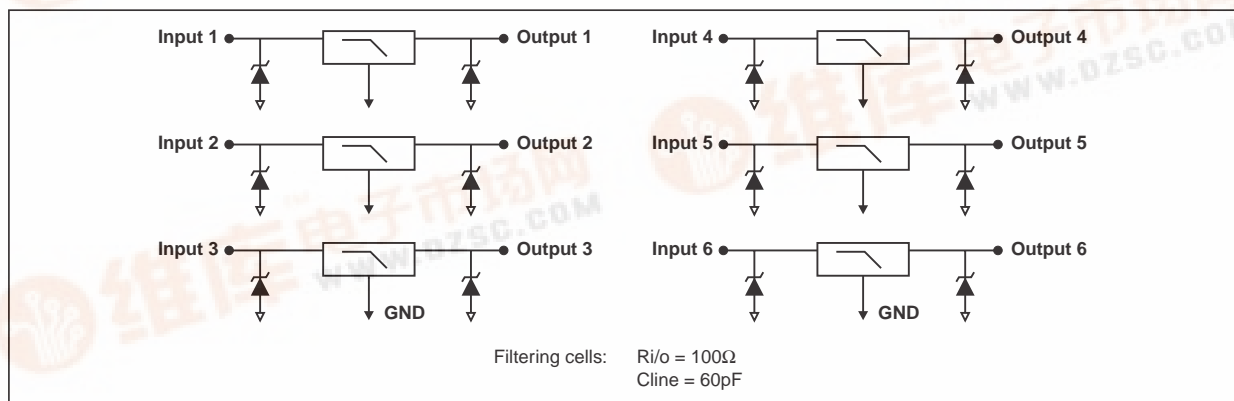
### COMPLIES WITH THE FOLLOWING STANDARDS :

IEC 61000-4-2 level 4:

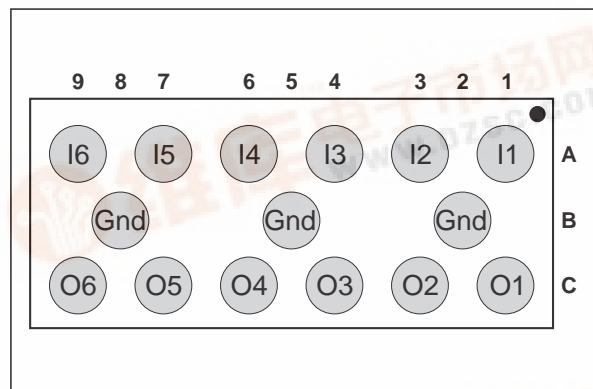
15kV (air discharge)  
8 kV (contact discharge)

MIL STD 883E - Method 3015-6 Class 3

### BASIC CELL CONFIGURATION



### PIN CONFIGURATION (ball side)



TM : IPAD is a trademark of STMicroelectronics.



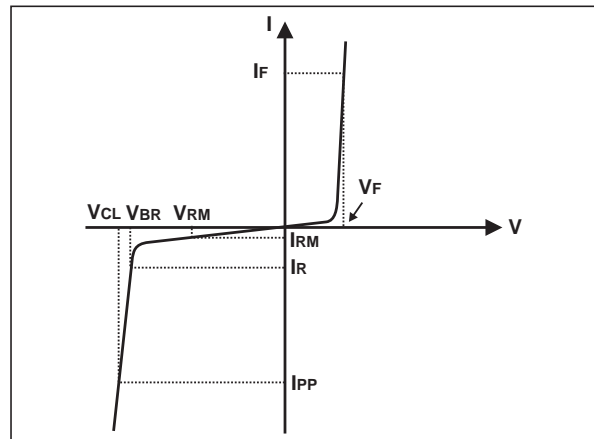
## EMIF06-10006F1

### ABSOLUTE RATINGS (limiting values)

Symbol	Parameter and test conditions	Value	Unit
$P_R$	DC power per resistance	0.1	W
$P_T$	Total DC power per package	0.6	W
$T_j$	Maximum junction temperature	125	°C
$T_{op}$	Operating temperature range	-40 to + 85	°C
$T_{stg}$	Storage temperature range	125	°C

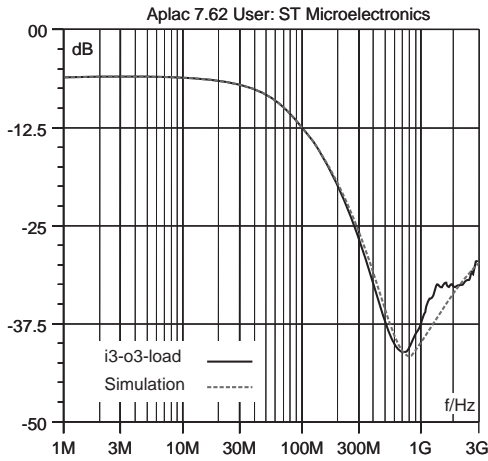
### ELECTRICAL CHARACTERISTICS ( $T_{amb} = 25\text{ °C}$ )

Symbol	Parameter
$V_{BR}$	Breakdown voltage
$I_{RM}$	Leakage current @ $V_{RM}$
$V_{RM}$	Stand-off voltage
$V_{CL}$	Clamping voltage
$R_d$	Dynamic impedance
$I_{PP}$	Peak pulse current
$R_{I/O}$	Series resistance between Input and Output
$C_{line}$	Input capacitance per line

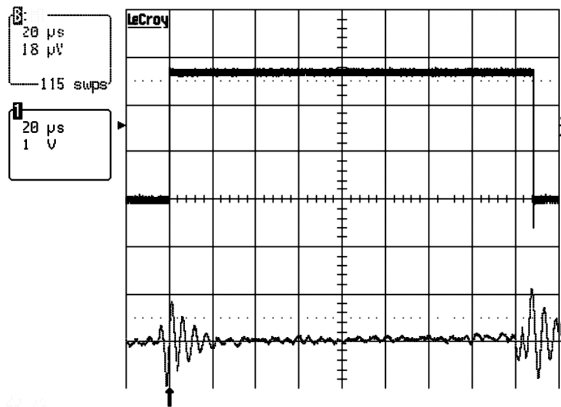


Symbol	Test conditions	Min.	Typ.	Max.	Unit
$V_{BR}$	$I_R = 1\text{ mA}$	5.5	7	9	V
$I_{RM}$	$V_{RM} = 3.3\text{ V per line}$			500	nA
$R_{I/O}$	$I = 10\text{ mA}$	80	100	120	$\Omega$
$C_{line}$	$V_R = 2.5\text{ V}$ , $F = 1\text{ MHz}$ , $30\text{ mV}$ (on filter cells)	50	60	70	pF

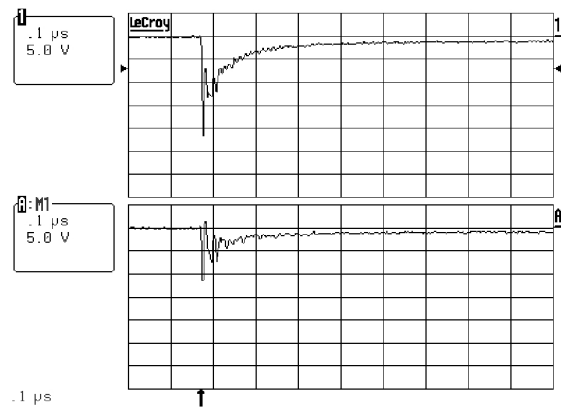
**Fig. 1:** S21 (dB) attenuation measurements and Aplac simulation.



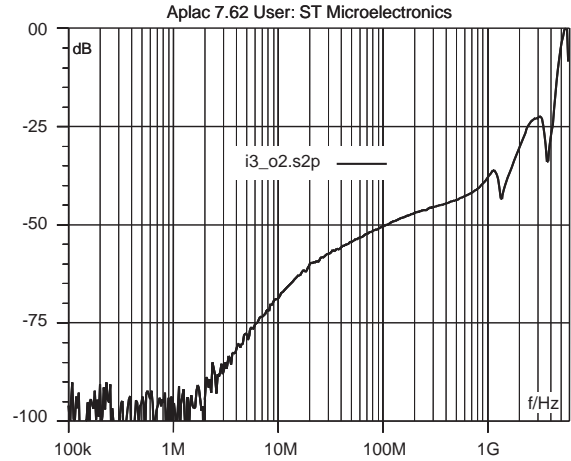
**Fig. 3:** Digital crosstalk measurements.



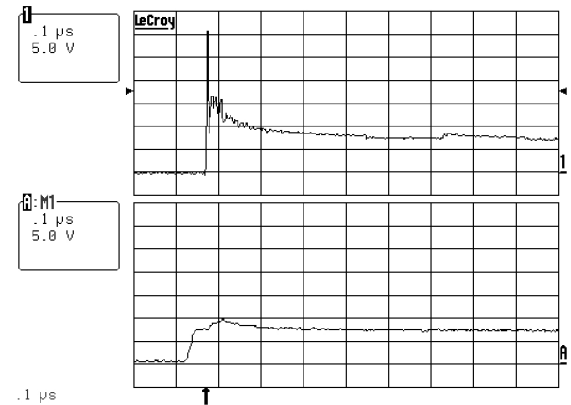
**Fig. 5:** ESD response to IEC61000-4-2 (-15kV air discharge) on one input V(in) and one output V(out).



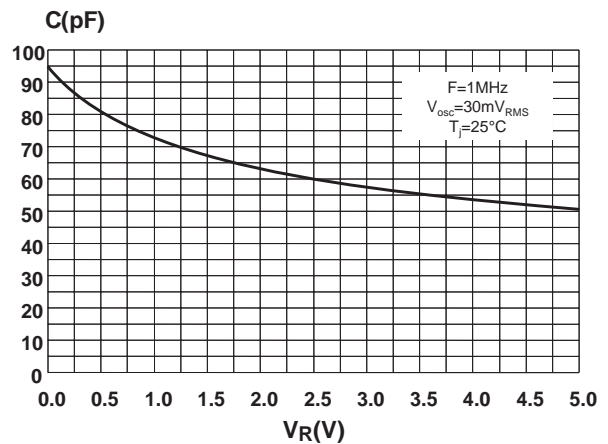
**Fig. 2:** Analog crosstalk measurements.



**Fig. 4:** ESD response to IEC61000-4-2 (+15kV air discharge) on one input V(in) and one output V(out).

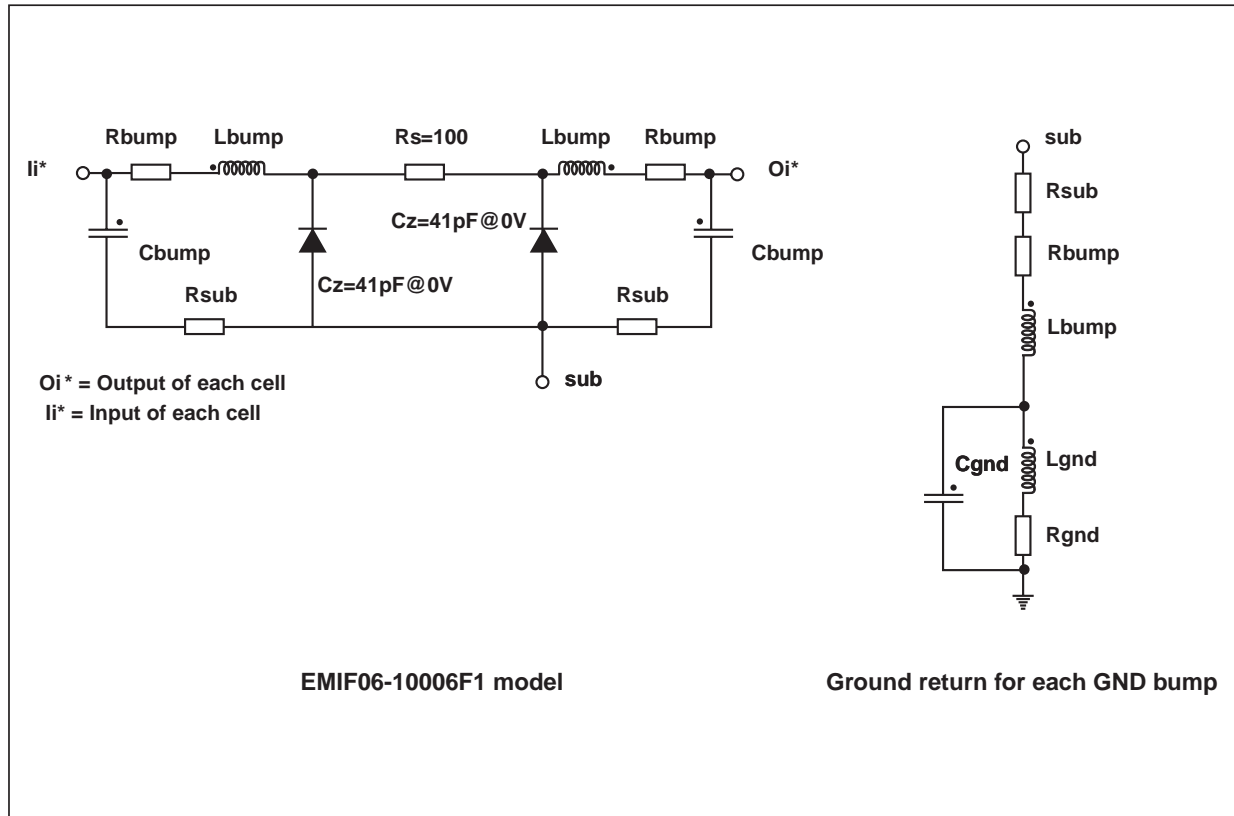


**Fig. 6:** Line capacitance versus applied voltage for filter.



## EMIF06-10006F1

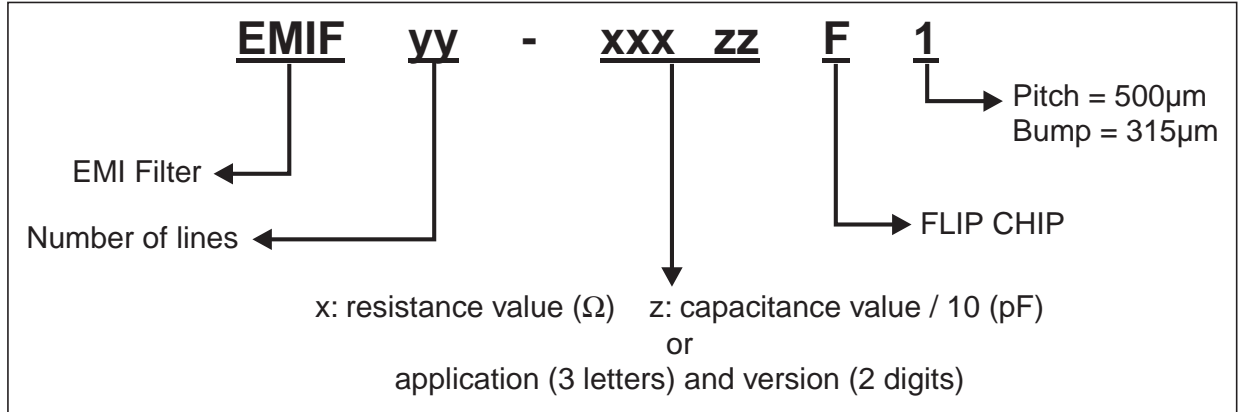
### Aplac model



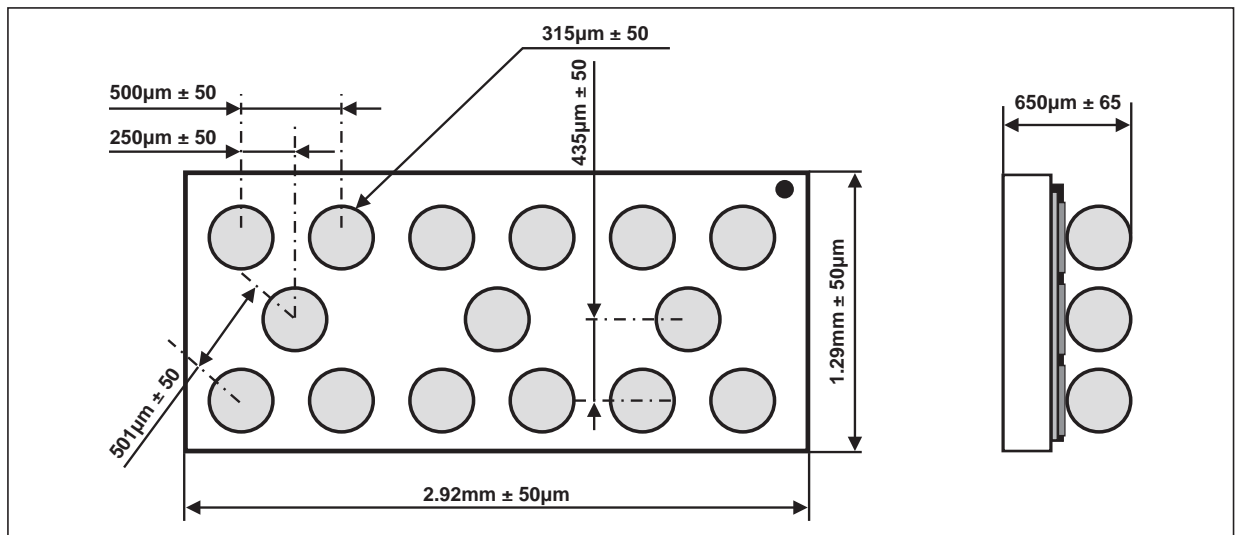
### Aplac parameters

aplacvar $R_s$	100 $\Omega$
aplacvar $C_z$	41 pF
aplacvar $L_{bump}$	50 pH
aplacvar $R_{bump}$	20 m
aplacvar $C_{bump}$	1.2 pF
aplacvar $R_{sub}$	100 m
aplacvar $R_{gnd}$	100 m
aplacvar $L_{gnd}$	100 pH
aplacvar $C_{gnd}$	0.15 pF

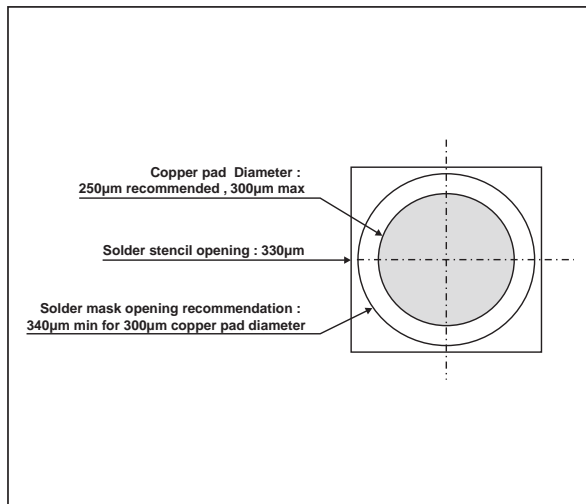
ORDER CODE



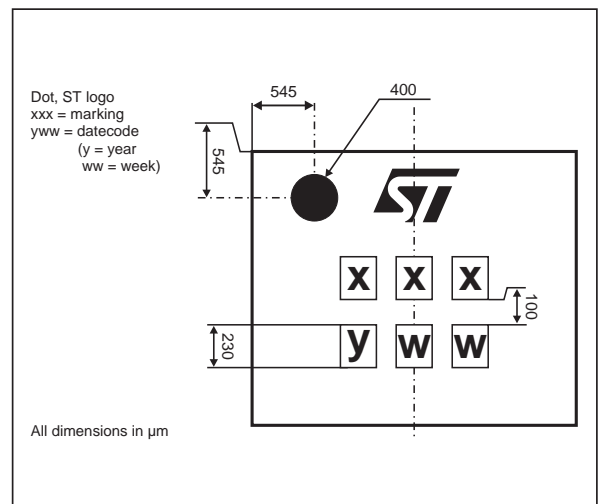
PACKAGE MECHANICAL DATA



FOOT PRINT RECOMMENDATIONS

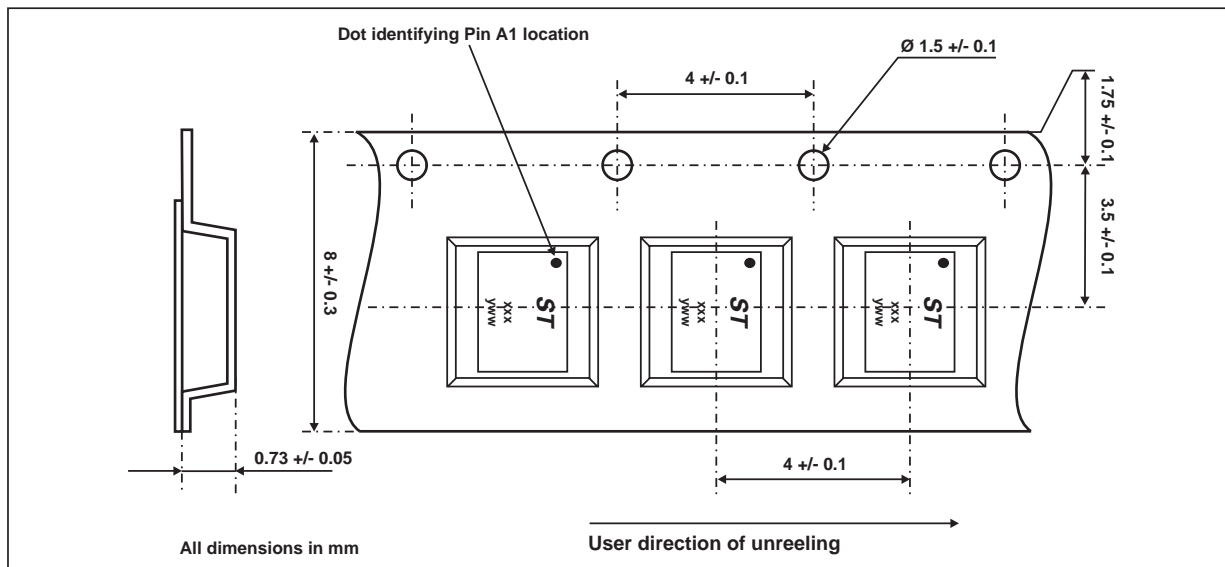


MARKING



# EMIF06-10006F1

## FLIP-CHIP TAPE AND REEL SPECIFICATION



## OTHER INFORMATION

Ordering code	Marking	Package	Weight	Base qty	Delivery mode
EMIF06-10006F1	FTT	Flip-Chip	5.4 mg	5000	Tape & reel

**Note:** More packing informations are available in the application note AN1235: "Flip-Chip: Package description and recommendations for use"

Information furnished is believed to be accurate and reliable. However, STMicroelectronics assumes no responsibility for the consequences of use of such information nor for any infringement of patents or other rights of third parties which may result from its use. No license is granted by implication or otherwise under any patent or patent rights of STMicroelectronics. Specifications mentioned in this publication are subject to change without notice. This publication supersedes and replaces all information previously supplied. STMicroelectronics products are not authorized for use as critical components in life support devices or systems without express written approval of STMicroelectronics.

The ST logo is a registered trademark of STMicroelectronics  
 © 2003 STMicroelectronics - Printed in Italy - All rights reserved.  
 STMicroelectronics GROUP OF COMPANIES  
 Australia - Brazil - Canada - China - Finland - France - Germany  
 Hong Kong - India - Israel - Italy - Japan - Malaysia - Malta - Morocco - Singapore  
 Spain - Sweden - Switzerland - United Kingdom - United States.

<http://www.st.com>