

Power Sequencing Controllers

The Intersil ISL6123, ISL6124, ISL6125, ISL6126, ISL6127, ISL6128 are integrated 4 channel controlled-on/controlled-off power-supply sequencers with supply monitoring, fault protection and a "sequence completed" signal (RESET#). For larger systems, more than 4 supplies can be sequenced by simply connecting a wire between SYSRESET# pins of cascaded IC's. The ISL6125 uses 4 open-drain outputs to control the 4 power supplies, and the other sequencers use a patented, micropower 7X chargepump to drive 4 external low-cost NFET switch gates above the supply rail by 5.3V. These IC's can be biased from any supply 5V down to 1.5V. Individual product descriptions are below.

The four channel **ISL6123** (ENABLE input), **ISL6124** (ENABLE# input) and **ISL6125** ICs offer the designer 4 rail control when it is required that all four rails are in minimal compliance prior to turn on and that compliance must be maintained during operation. The **ISL6123** has a low power standby mode when it is disabled, suitable for battery powered applications.

The **ISL6125** operates like the **ISL6124** but instead of charge pump driven gate drive outputs it has open drain logic outputs for direct interface to other circuitry.

In contrast to the ISL6123 and ISL6124, with the **ISL6126**, each of the four channels operates independently so that the various rails will turn on once its individual input voltage requirements are met.

The **ISL6127** is a preprogrammed A-B-C-D turn-on and D-C-B-A turn-off sequenced IC. Once all inputs are in compliance and **ENABLE** is asserted the sequencing starts and each subsequent GATE will turn-on after the previous one completes turning-on.

The **ISL6128** has two groups of two channels each with its independent I/O and is ideal for voltage sequencing into redundant capability loads as all four inputs need to be satisfied prior to turn on but a single group fault is ignored by the other group.

External resistors provide flexible voltage threshold programming of monitored rail voltages. Delay and sequencing are provided by external capacitors for both ramp up and ramp down.

Additional I/O is provided indicating and driving RESET state in various configurations.

For volume applications, other programmable options and features can be had. Contact the factory with your needs.

Features

- Enables arbitrary turn-on and turn-off sequencing of up to four power supplies (0.7V - 5V)
- Operates from 1.5V to 5V supply voltage
- Supplies $V_{DD} + 5.3V$ of charge pumped gate drive
- Adjustable voltage slew rate for each rail
- Multiple sequencers can be daisy-chained to sequence an infinite number of independent supplies
- Glitch immunity
- Under voltage lockout for each supply
- 1 μ A Sleep State (**ISL6123**)
- Active high (**ISL6123**) or low (**ISL6124**) ENABLE# input
- Open drain version available (**ISL6125**)
- Pre programmed Sequence available (**ISL6127**)
- Dual channel groupings (**ISL6128**)
- QFN Package with Pb-free plus anneal option

Applications

- Graphics cards
- FPGA/ASIC/microprocessor/PowerPC supply sequencing
- Network routers
- Telecommunications systems

Ordering Information

PART NUMBER	TEMP. RANGE (°C)	PACKAGE	PKG. DWG. #
ISL6123IR	-40 to +85	24 Ld 4x4 QFN	L24.4x4
ISL6124IR			
ISL6125IR			
ISL6126IR			
ISL6127IR			
ISL6128IR			
ISL6123IRZA (Note)	-40 to +85	24 Ld 4x4 QFN (Pb-free)	
ISL6124IRZA (Note)			
ISL6125IRZA (Note)			
ISL6126IRZA (Note)			
ISL6127IRZA (Note)			
ISL6128IRZA (Note)			
ISL612XSEQEVAL1	Evaluation Platform		

NOTE: Intersil Pb-free plus anneal products employ special Pb-free material sets; molding compounds/die attach materials and 100% matte tin plate termination finish, which are RoHS compliant and compatible with both SnPb and Pb-free soldering operations. Intersil Pb-free products are MSL classified at Pb-free peak reflow temperatures that meet or exceed the Pb-free requirements of IPC/JEDEC J STD-020.



ISL6123, ISL6124, ISL6125, ISL6126, ISL6127, ISL6128

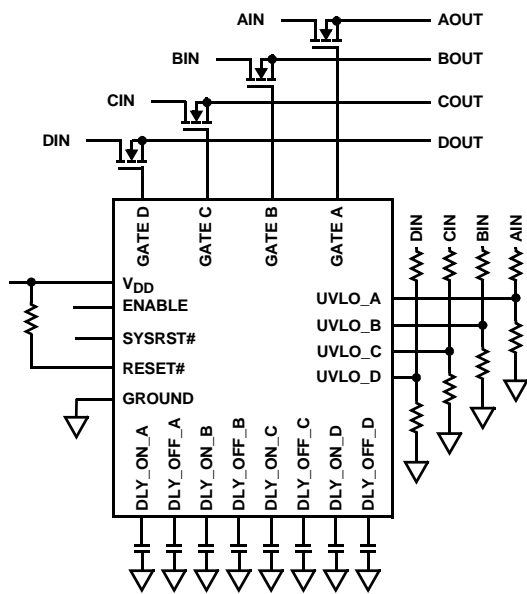
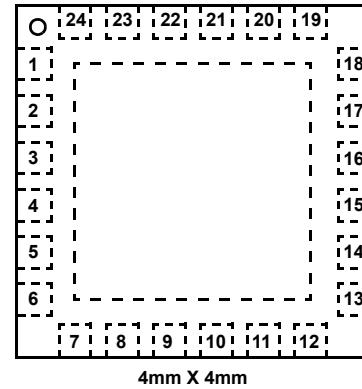

FIGURE 1. TYPICAL ISL6123 APPLICATION USAGE

Pinout

ISL6123, ISL6124, ISL6125,
ISL6126, ISL6127, ISL6128 (QFN)
TOP VIEW



Pin Descriptions

PIN #	PIN NAME	FUNCTION	DESCRIPTION
23	VDD	Chip Bias	Bias IC from nominal 1.5V to 5V
10	GND	Bias Return	IC ground
1	ENABLE_1/ ENABLE#_1	Input to start on/off sequencing.	Input to initiate the start of the programmed sequencing of supplies on or off. Enable functionality is disabled for 10ms after UVLO is satisfied. ISL6123 has ENABLE. ISL6124, ISL6125, ISL6126 and ISL6127 have ENABLE#. Only ISL6128 has 2 ENABLE# inputs, 1 for each 2 channel grouping. EN_1# for (A, B), and EN_2# for (C, D).
11	ENABLE#_2		
24	RESET#	RESET# Output	RESET# provides a low signal 150ms after all GATEs are fully enhanced. This delay is for stabilization of output voltages. RESET# will assert low upon UVLO not being satisfied or ENABLE/ENABLE# being deasserted. The RESET outputs are open drain N channel FET and is guaranteed to be in the correct state for VDD down to 1V and is filtered to ignore fast transients on VDD and UVLO_X. RESET#_2 only exists on ISL6128 for (C, D) group I/O.
9	RESET#_2		
20	UVLO_A	Under Voltage Lock Out/Monitoring Input	These inputs provide for a programmable UV lockout referenced to an internal 0.633V reference and are filtered to ignore short (<30µs) transients below programmed UVLO level.
12	UVLO_B		
17	UVLO_C		
14	UVLO_D		
21	DLY_ON_A	Gate On Delay Timer Output	Allows for programming the delay and sequence for Vout turn-on using a capacitor to ground. Each cap is charged with 1µA, 10ms after turn-on initiated by ENABLE/ENABLE# with an internal current source providing delay to the associated FETs GATE turn-on. These pins are NC on ISL6126 and ISL6127
8	DLY_ON_B		
16	DLY_ON_C		
15	DLY_ON_D		
18	DLY_OFF_A	Gate Off Delay Timer Output	Allows for programming the delay and sequence for Vout turn-off through ENABLE/ENABLE# via a capacitor to ground. Each cap is charged with a 1µA internal current source to an internal reference voltage causing the corresponding gate to be pulled down turning-off the FET. These pins are NC on ISL6127
13	DLY_OFF_B		
3	DLY_OFF_C		
4	DLY_OFF_D		

ISL6123, ISL6124, ISL6125, ISL6126, ISL6127, ISL6128

Pin Descriptions (Continued)

PIN #	PIN NAME	FUNCTION	DESCRIPTION
2	GATE_A	FET Gate Drive Output ISL6125 Open Drain Outputs	Drives the external FETs with a 1µA current source to soft start ramp into the load. On the ISL6125 only, these are open drain outputs that can be pulled up to a maximum of VDD voltage.
5	GATE_B		
6	GATE_C		
7	GATE_D		
22	SYSRST#	System Reset I/O	As an input, allows for immediate and unconditional latch-off of all GATE outputs when driven low. This input can also be used to initiate the programmed sequence with 'zero' wait (no 10ms stabilization delay) from input signal on this pin being driven high to first GATE. As an output when there is a UV condition this pin pull low. If common to other SYSRST# pins in a multiple IC configuration it will cause immediate and unconditional latch-off of all other GATES on all other ISL612X sequencers. This pin is a NC on ISL6126 and ISL6128
19	No Connect	No Connect	No Connect

ISL612X Variant Feature Matrix

PART NAME	EN/EN#	CMOS/TTL	GATE DRIVE OR OPEN DRAIN OUTPUTS	REQUIRED CONDITIONS FOR INITIAL START-UP	NUMBER OF UVLO INPUTS MONITORED BY EACH RESET#	NUMBER OF CHANNELS THAT TURN-OFF WHEN 1 UVLO FAULTS	PRESET OR ADJUSTABLE SEQUENCE	NUMBER OF UVLO AND PAIRS OF I/O	FEATURES
ISL6123	EN	TTL	Gate Drive	4 UVLO 1 EN	4 UVLO	4 Gates	Adjustable On & Off	4 Monitors with 1 I/O	Auto restart
ISL6124	EN#	CMOS	Gate Drive	4UVLO 1 EN	4 UVLO	4 Gates	Adjustable On & Off	4 Monitors with 1 I/O	Auto restart
ISL6125	EN#	CMO	Open Drain	4 UVLO 1 EN	4 UVLO	4 Open Drain	Adjustable On & Off	4 Monitors with 1 I/O	Auto restart
ISL6126	EN#	CMOS	Gate Drive	1 UVLO 1 EN	4 UVLO	1 Gate	Adjustable Off	4 Monitors with 1 I/O	Gates independent on as UVLO Valid
ISL6127	EN#	CMOS	Gate Drive	4 UVLO 1 EN	4 UVLO	4 Gates	Preset	4 Monitors with 1 I/O	Auto restart
ISL6128	EN#	CMOS	Gate Drive	4 UVLO 2 EN	2 UVLO	2 Gates	Preset	2 Monitors with 2 I/O	Dual Redundant Operation

ISL6123, ISL6124, ISL6125, ISL6126, ISL6127, ISL6128

Absolute Maximum Ratings

V _{DD}	+6.0V
GATE	-0.3V to V _{DD} +6V
ISL6125 LOGIC OUT	-0.3V to V _{DD} +0.3V
UVLO, ENABLE, ENABLE#, SYSRST#	-0.3V to V _{DD} +0.3V
RESET#, DLY_ON, DLYOFF	-0.3V to V _{DD} +0.3V
ESD Classification	2.5kV (HBM)

Thermal Information

Thermal Resistance (Typical, Notes 1, 2)	θ_{JA} (°C/W)	θ_{JC} (°C/W)
4 x 4 QFN Package	48	9
Maximum Junction Temperature	150°C	
Maximum Storage Temperature Range	-65°C to 150°C	
Maximum Lead Temperature (Soldering 10s)	300°C (QFN - Leads Only)	

Operating Conditions

V _{DD} Supply Voltage Range	+1.5V to +5.5V
Temperature Range (T _A)	-40°C to 85°C

CAUTION: Stresses above those listed in "Absolute Maximum Ratings" may cause permanent damage to the device. This is a stress only rating and operation of the device at these or any other conditions above those indicated in the operational sections of this specification is not implied.

NOTES:

1. θ_{JA} is measured with the component mounted on a high effective thermal conductivity test board in free air. See Tech Brief TB379 for details.
2. For θ_{JC} , the "case temp" location is the center of the exposed metal pad on the package underside.
3. All voltages are relative to GND, unless otherwise specified.

Electrical Specifications V_{DD} = 1.5V to +5V, T_A = T_J = -40°C - 85°C, Unless Otherwise Specified.

PARAMETER	SYMBOL	TEST CONDITIONS	MIN	TYP	MAX	UNIT
UVLO						
Undervoltage Lockout Threshold	V _{UVLOvth}	T _J = +25°C	619	633	647	mV
Undervoltage Lockout Threshold Temp Co	TC _{UVLOvth}	T _J = -40°C to 85°C	-	40	-	nV/°C
Undervoltage Lockout Hysteresis	V _{UVLOhys}		-	10	-	mV
Undervoltage Lockout Threshold Range	RUVLOvth	Max V _{UVLOvth} - Min V _{UVLOvth}	-	7	-	mV
Undervoltage Lockout Delay	TUVLOdel	ENABLE satisfied	-	10	-	ms
Transient Filter Duration	TFIL	V _{DD} , UVLO, ENABLE glitch filter	-	30	-	µs
DELAY ON/OFF						
Delay Charging Current	DLY_ichg	V _{DLY} = 0V	0.92	1	1.08	µA
Delay Charging Current Range	DLY_ichg_r	DLY_ichg(max) - DLY_ichg(min)	-	0.08	-	µA
Delay Charging Current Temp. Coeff.	TC_DLY_ichg		-	0.2	-	nA/°C
Delay Threshold Voltage	DLY_Vth		1.238	1.266	1.294	V
Delay Threshold Voltage Temp. Coeff.	TC_DLY_Vth		-	0.2	-	mV/°C
ENABLE/ENABLE#, RESET# & SYSRST# I/O						
ENABLE Threshold	V _{ENh}		-	1.2	-	V
ENABLE# Threshold	V _{ENh}		-	0.5 V _{DD}	-	V
ENABLE/ENABLE# Hysteresis	V _{ENh} - V _{ENl}	Measured at V _{DD} = 1.5V	-	0.2	-	V
ENABLE/ENABLE# Lockout Delay	TdelEN_LO	UVLO satisfied	-	10	-	ms
RESET# Pull-Down Current	I _{RSTpd}	\overline{RST} = 0.1V	-	13	-	mA
RESET# Delay after GATE High	T _{RSTdel}	GATE = V _{DD} +5V	-	160	-	ms
RESET# Output Low	V _{RSTl}	Measured at V _{DD} = 5V with 5K pullup resistors	-	-	0.001	V
SYSRST# Low to GATE Turn-off	TdelSYS_G	GATE = 80% of V _{DD} +5V	-	40	-	ns
GATE						
GATE Turn-On Current	I _{GATEon}	GATE = 0V	0.8	1.1	1.4	µA
GATE Turn-Off Current	I _{GATEoff_l}	GATE = V _{DD} , Disabled	-1.4	-1.05	-0.8	µA

ISL6123, ISL6124, ISL6125, ISL6126, ISL6127, ISL6128

Electrical Specifications $V_{DD} = 1.5V$ to $+5V$, $T_A = T_J = -40^{\circ}C - 85^{\circ}C$, Unless Otherwise Specified. (Continued)

PARAMETER	SYMBOL	TEST CONDITIONS	MIN	TYP	MAX	UNIT
GATE Current Range	I_{GATE_range}	Within IC I_{GATE} max-min	-	-	0.35	μA
GATE Turn-On/Off Current Temp. Coeff.	$TC_{I_{GATE}}$		-	0.2	-	$nA/^{\circ}C$
GATE Pull-Down High Current	$I_{GATEoff_h}$	GATE = V_{DD} , UVLO = 0V	-	88	-	mA
GATE High Voltage	V_{GATEh}	Gate High Voltage	$V_{DD}+5V$	$V_{DD}+5.3V$	-	V
GATE Low Voltage	$V_{GATE_}$	Gate Low Voltage, $V_{DD} = 1V$	-	0	0.1	V
BIAS						
IC Supply Current	I_{VDD_5V}	$V_{DD} = 5V$	-	0.20	0.5	mA
IC Supply Current	$I_{VDD_3.3V}$	$V_{DD} = 3.3V$	-	0.14	-	mA
IC Supply Current	$I_{VDD_1.5V}$	$V_{DD} = 1.5V$	-	0.10	-	mA
ISL6123 Stand By IC Supply Current	I_{VDD_sb}	$V_{DD} = 5V$, ENABLE = 0V	-	-	1	μA
V_{DD} Power On Reset	V_{DD_POR}		-	-	1	V

ISL6123, 24, 25, 26, 27, 28 Descriptions and Operation

The ISL612X sequencer family consists of several four channel voltage sequencing controllers in various functional and personality configurations. All are designed for use in multiple-voltage systems requiring power sequencing of various supply voltages. Individual voltage rails are gated on and off by external N-Channel MOSFETs, the gates of which are driven by an internal charge pump to $V_{DD} + 5.3V$ (VQP) in a user programmed sequence.

With the four-channel ISL6123 the ENABLE must be asserted high and all four voltages to be sequenced must be above their respective user programmed Under Voltage Lock Out (UVLO) levels before programmed output turn on sequencing can begin. Sequencing and delay determination is accomplished by the choice of external cap values on the DLY_ON and DLY_OFF pins. Once all 4 UVLO inputs and ENABLE are satisfied for 10ms, the four DLY_ON caps are simultaneously charged with $1\mu A$ current sources to the DLY_Vth level of 1.27V. As each DLY_ON pin reaches the DLY_Vth level its associated GATE will then turn-on with a $1\mu A$ source current to the VQP voltage of $V_{DD} + 5.3V$. Thus all four GATES will sequentially turn on. Once at DLY_Vth the DLY_ON pins will discharge to be ready when next needed. After the entire turn on sequence has been completed and all GATES have reached the charge pumped voltage (VQP), a 160ms delay is started to ensure stability after which the RESET# output will be released to go high. Subsequent to turn-on, if any input falls below its UVLO point for longer than the glitch filter period ($\sim 30\mu s$) this is considered a fault. RESET# and SYSRST# are pulled low and all GATES are simultaneously also pulled low. In this mode the GATES are pulled low with 88mA. Normal shutdown mode is entered when no UVLO is violated and the ENABLE is deasserted. When ENABLE is deasserted, RESET# is asserted and pulled low. Next, all four shutdown ramp caps on the DLY_OFF pins are

charged with a $1\mu A$ source and when any ramp-cap reaches DLY_Vth, a latch is set and a current is sunk on the respective GATE pin to turn off its external MOSFET. When the GATE voltage is approximately 0.6V, the GATE is pulled down the rest of the way at a higher current level. Each individual external FET is thus turned off removing the voltages from the load in the programmed sequence.

The ISL6123 and ISL6124 have the same functionality except for the ENABLE active polarity with the ISL6124 having an ENABLE# input. Additionally the ISL6123 also has an ultra low power sleep state when ENABLE is low.

The ISL6125 has the same personality as the ISL6124 but instead of charged pump driven GATE outputs it has open drain LOGIC outputs that can be pulled up to a maximum of V_{DD} .

The ISL6126 is unique in that its sequence on is not time determined but voltage determined. Its personality is that each of the four channels operates independently so that once the IC is biased and any one of the UVLO inputs is greater than the 0.63V internal reference, and ENABLE# input is also satisfied the GATE for the associated UVLO input will turn-on. In turn the other UVLO inputs need to be satisfied for the associated GATES to turn-on. 150ms after all GATES are fully on (GATE voltage = VQP) the RESET# is released to go high. The UVLO inputs can be driven by either a previously turned on output rail offering a voltage determined sequence or by logic signal inputs. Any subsequent UVLO level < its programmed level will pull the RESET# output low (if previously released), but will not latch-off the other outputs. Predetermined turn-off is accomplished by signaling ENABLE# high, this will cause RESET# to latch low and all four GATE outputs to follow the programmed turn off sequence similar to a ISL6124.

The ISL6127 is a four channel sequencer pre-programmed for A-B-C-D turn-on and D-C-B-A turn-off. After all four UVLO and ENABLE# inputs are satisfied for $\sim 10ms$, the sequencing starts and the next GATE in the sequence starts to ramp up once the

ISL6123, ISL6124, ISL6125, ISL6126, ISL6127, ISL6128

previous GATE has reached $\sim V_{QP}-1V$. 160ms after the last GATE is at VQP the RESET# output will be deasserted. Once any UVLO is unsatisfied, RESET# is pulled low, SYSRST# is pulled low and all GATEs are simultaneously turned off. When ENABLE# is signaled high the D GATE will start to pull low and once below 0.6V the next GATE will then start to pull low and so on until all GATEs are at 0V. Unloaded, this turn off sequence will complete in $<1ms$. This variant offers a lower cost and size implementation as the external delay caps are not used. Since the delay caps are not used this IC can not delay the start of subsequent GATEs thus necessary stabilization or system house keeping need to be considered.

The **ISL6128** is a four channel device that groups the four channels into two groups of two channels each, as A, B and C, D. Each group having its own ENABLE# and RESET# I/O pins. This requires all four UVLO and both ENABLE#s to be satisfied for sequencing to start. The A, B group will first turn on 10ms after the second ENABLE# is pulled low with A then B turning on followed by C then D. Once the preceding GATE = VQP the next DLY_ON pin starts to charge its capacitor thus turning on all four GATEs. Approximately 160ms after D GATE = VQP the RESET# output is released to go high. Once any UVLO is unsatisfied, only the related group's RESET# and two GATEs are pulled low. The related EN input has to be cycled for the faulted group to be turned-on again. Normal shutdown is invoked by either signaling both ENABLE# inputs high which will cause all the two related GATEs to shutdown in reverse order from turn-on. DLY_X caps adjust the delay between GATES during turn on and off but not the order.

During bias up the RESET# output is guaranteed to be in the correct state with V_{DD} lower than 1V.

The SYSRST# pin is a true I/O connection having both functions. As an input, if it is pulled low all GATEs will unconditionally shut off and RESET# pulls low, see Figure 6. This input can be used as a no wait enabling input, if all inputs (ENABLE & UVLO) are satisfied it does not wait through the $\sim 10ms$ enable delay to initiate DLY_ON cap charging. It is also useful when multiple sequencers are implemented in a design needing simultaneous shutdown (kill switch) across all sequencers. As an output, after the on sequence is completed it will pull low after any UVLO is unsatisfied longer than T_{FIL} and pull all other SYSRST# inputs low on common connection thus unconditionally shutting down all outputs across multiple sequencers.

Except ISL6128 after a fault, restart of the turn on sequence is automatic once all requirements are met. This allows for no interaction between the sequencer and a controller IC if desired. The ENABLE & RESET# I/O do allow for a higher level of feedback and control if desired. The ISL6128 requires that the related ENABLE# be cycled for restart of its associated group GATEs.

If no capacitors are connected between DLY_ON or DLY_OFF pins and ground then all such related GATEs start to turn on immediately after the 10ms ($T_{UVLOdel}$) ENABLE stabilization time out has expired and the GATEs start to immediately turn off when ENABLE is asserted.

If some of the rails are to be sequenced together, in order to eliminate the effect of capacitor variance on the timing and to reduce cost, a common capacitor can be connected to two or more DLY_ON or DLY_OFF pins. In this case multiply the capacitor value by the number of common DLY_X pins to retain the desired timing.

Table 1 illustrates the nominal time delay from the start of charging to the 1.27V reference for various capacitor values on the DLY_X pins. This table does not include the 10ms of enable lock out delay during a start up sequence but represents the time from the end of the enable lock out delay to the start of GATE transition. There is no enable lock out delay for a sequence off, so this table illustrates the delay to GATE transition from a disable signal.

TABLE 1.

NOMINAL DELAY TO SEQUENCING THRESHOLD	
DLY PIN CAPACITANCE	TIME (s)
Open	0.00006
100pF	0.00013
1000pF	0.0013
0.01 μ F	0.013
0.1 μ F	0.13
1 μ F	1.3
10 μ F	13

NOTE: Nom. $T_{DEL_SEQ} = Cap (\mu F) * 1.3M\Omega$.

Figure 2 illustrates the turn-on and Figure 3 the nominal turnoff timing diagram of the **ISL6123** and **ISL6124** product.

The **ISL6125** is similar except the open drains instead of GATE pins are pulled up to V_{DD} .

Note the delay and flexible sequencing possibilities.

ISL6123, ISL6124, ISL6125, ISL6126, ISL6127, ISL6128

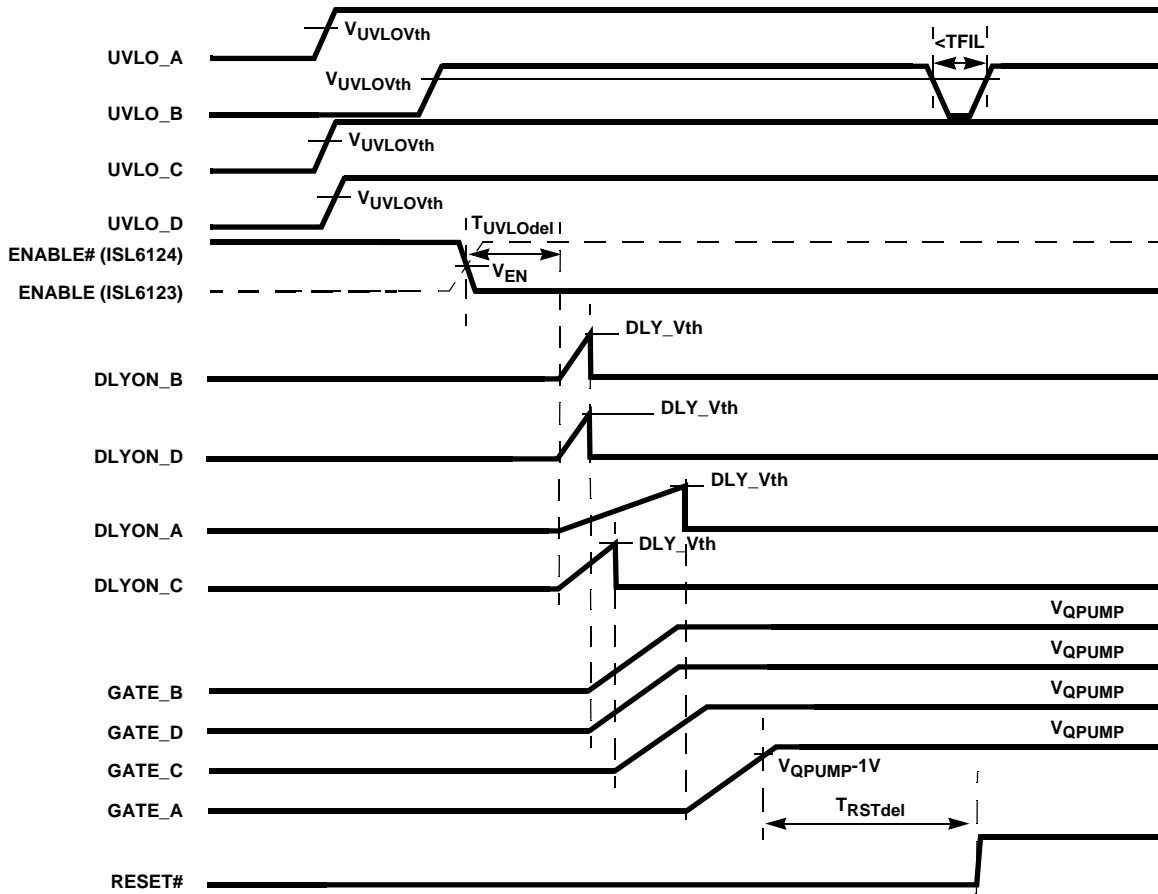

FIGURE 2. ISL6123/ISL6124 TURN-ON AND GLITCH RESPONSE TIMING DIAGRAM

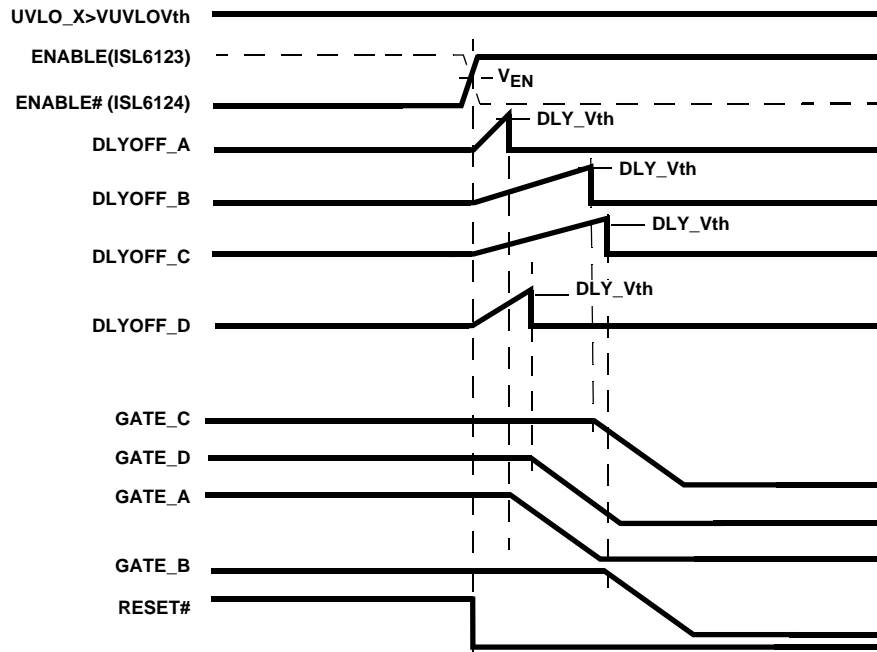

FIGURE 3. ISL6123/ISL6124 TURN-OFF TIMING DIAGRAM

Typical Performance Curves

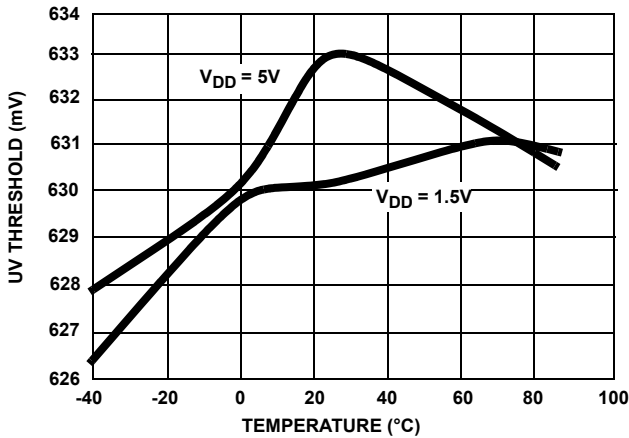

FIGURE 4. UVLO THRESHOLD VOLTAGE

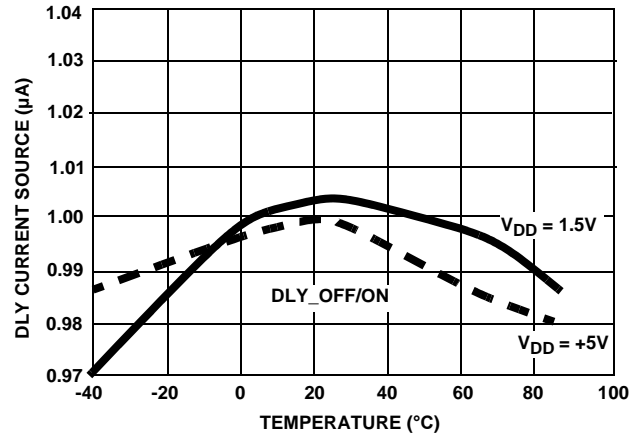

FIGURE 5. DLY CHARGE CURRENT

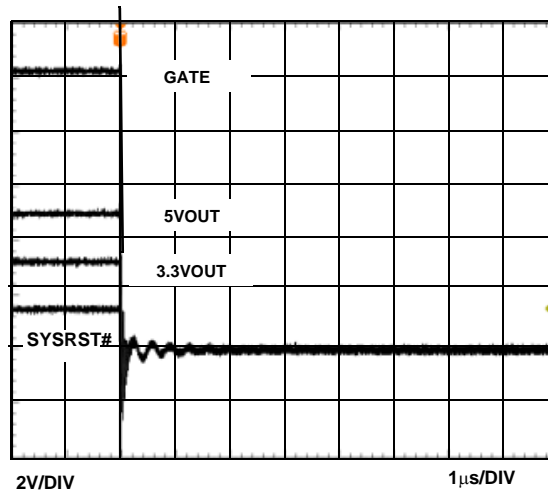

FIGURE 6. SYSRST# LOW TO OUTPUT LATCH OFF

Using the ISL612XSEQEVAL1 Platform

The **ISL612XSEQEVAL1** platform is the primary evaluation board for this family. The board has 2 complete, separate and electrically identical circuits, see Figure 15 for schematic and Figure 16 for a photo.

In the top right hand corner of the board is a SMD layout with a **ISL6123** illustrating the full functionality and small implementation size for an application having the highest component count.

The majority of the board is given over to a socket and discrete through-hole components circuit for ease of evaluation flexibility through IC variant swapping and modification of UVLO levels and sequencing order by passive component substitution.

The board is shipped with the **ISL6123** installed in both locations and with two each of the other released variant types loose packed. As this sequencer family has a common function pinout there are no major modifications to the board

necessary to evaluate the other ICs. The **ISL6125** due to its having open drain outputs can be evaluated on the **ISL612XSEQEVAL1** with a minor modification or on the **ISL613XSUPEREVAL2** evaluation platform. To modify for **ISL6125** evaluation, pull-up resistors must be added from the GATE outputs to a pull-up voltage of 1.5V to prevent FET turn-on or remove FETs to eliminate this voltage restriction.

To the left, right and above the socket are four test point strips (TP1-TP4). These give access to the labeled IC I/O pins during evaluation. Remember that significant current or capacitive loading of particular I/O pins will affect functionality and performance.

Attention to orientation and placement of variant ICs in the socket must be paid to prevent IC damage or faulty evaluation.

The default configuration of the **ISL612XSEQEVAL1** circuitries was built around the following design assumptions:

ISL6123, ISL6124, ISL6125, ISL6126, ISL6127, ISL6128

1. Using the **ISL6123IR** or **ISL6124IR**
2. The four supplies being sequenced are 5V (IN_A), 3.3V (IN_B), 2.5V (IN_C) and 1.5V (IN_D), the UVLO levels are ~ 80% of nominal voltages. Resistors chosen such that the total resistance of each divider is ~ 10K using standard value resistors to approximate 80% of nominal = 0.63V on UVLO input.
3. The desired order turn-on sequence is first both 5V and 3.3V supplies together and then the 2.5V supply about 75ms later and lastly the 1.5V supply about 45ms later.
4. The desired turn-off sequence is first both 1.5V and 3.3V supplies at the same time then the 2.5V supply about 50ms later and lastly the 5V supply about 72ms after that.

All scope shots taken from ISL612xSEQEVAL1 board. Figures 7 and 8 illustrate the desired turn-on and turn-off sequences respectively. The sequencing order and delay between voltages sequencing is set by external capacitance values so other than illustrated can be accomplished.

Figures 9 and 10 illustrate the timing relationships between the EN input, RESET#, DLY and GATE outputs and the VOUT voltage for a single channel being turned on and off respectively. RESET# is not shown in Figure 9 as it asserts 160ms after the last GATE goes high.

Typical Performance Waveforms

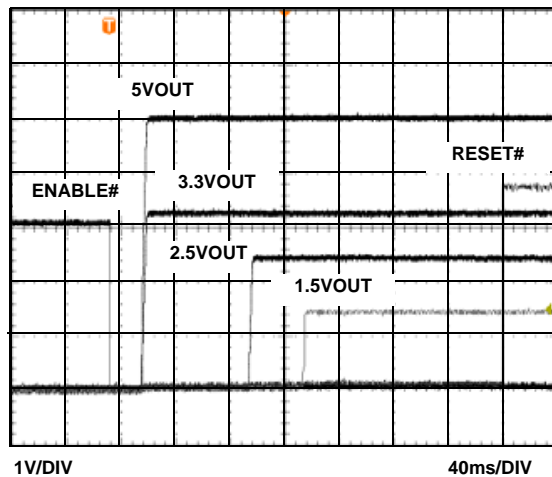

FIGURE 7. ISL6124 SEQUENCED TURN-ON

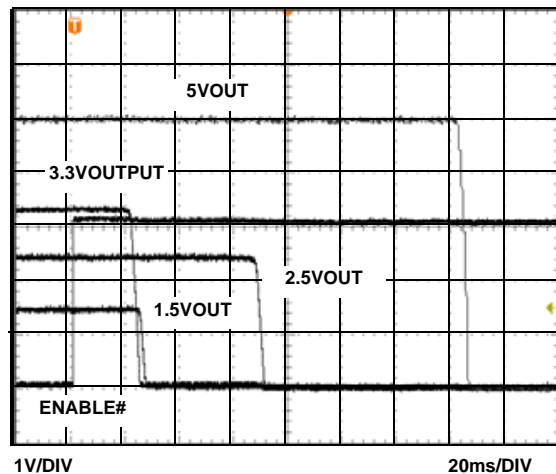

FIGURE 8. ISL6124 SEQUENCED TURN-OFF

All IC family variants share similar function for DLY_X capacitor charging, GATE and RESET# operation. Figures 11 through 14 illustrate the principal feature and functional differences for each of the ISL6125, ISL6126, ISL6127 and ISL6128 variants, each is described below.

Figure 11 features the 6125 open drain outputs being sequenced on and off along with RESET# relationship which is similar to all other family variants.

Figure 12 illustrates the independent input feature of the ISL6126 which allows once the EN# is low for each UVLO to be individually satisfied and for its associated GATE to turn-on. Only when the last variable VIN is satisfied as shown does the RESET# release to signal all input voltages are valid.

Figure 13 shows the ISL6127 pre programmed ABCD on DCBA off order of sequencing with minimal non adjustable delay between each.

Figure 14 demonstrates the independence of the redundant two rail sequencer. It shows that either one of the two groups can be turned off and the ABCD order of restart with capacitor programmable delay once both EN inputs are pulled low.

ISL6123, ISL6124, ISL6125, ISL6126, ISL6127, ISL6128

Typical Performance Waveforms (Continued)

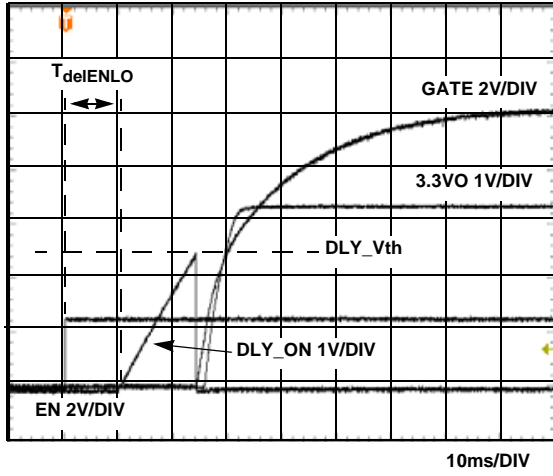

FIGURE 9. ISL6123 SINGLE CHANNEL TURN-ON

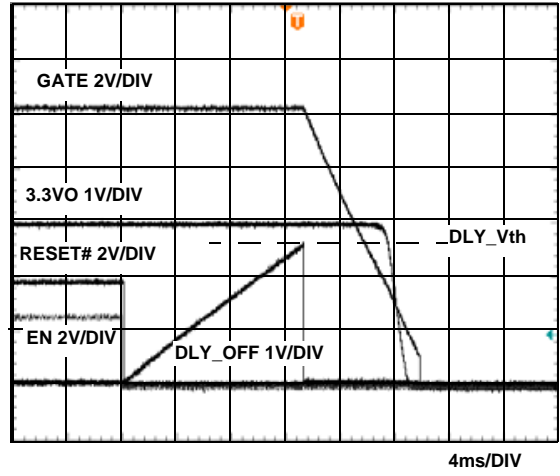

FIGURE 10. ISL6123 SINGLE CHANNEL TURN-OFF

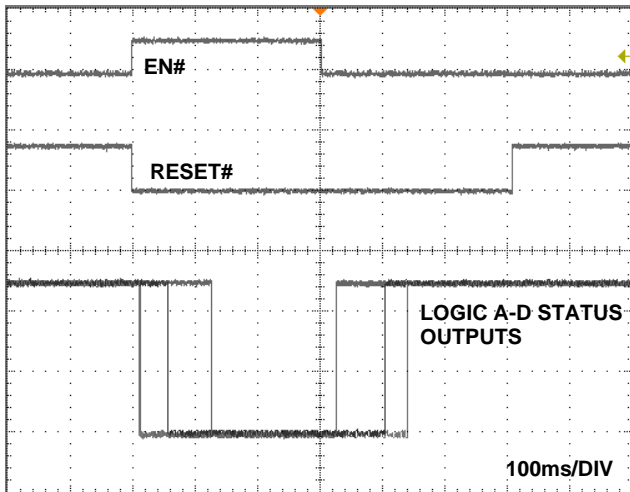

FIGURE 11. ISL6125 LOGIC OUTPUTS SEQUENCED ON AND OFF AND RESET# RELATIONSHIP

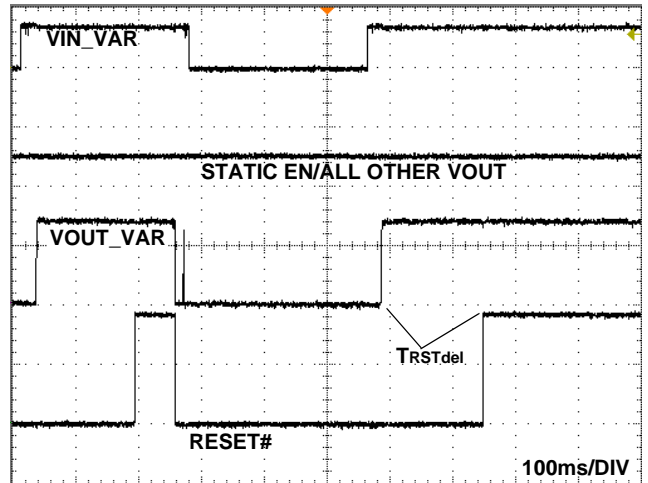

FIGURE 12. ISL6126 UVLO INPUT/OUTPUT INDEPENDANCE AND RESET# RELATIONSHIP

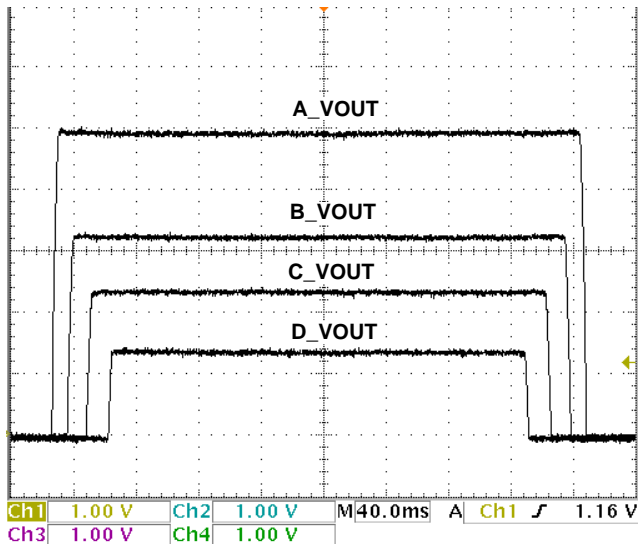

FIGURE 13. ISL6127 PREPROGRAMMED ABCD TURN-ON AND DCBA TURN-OFF

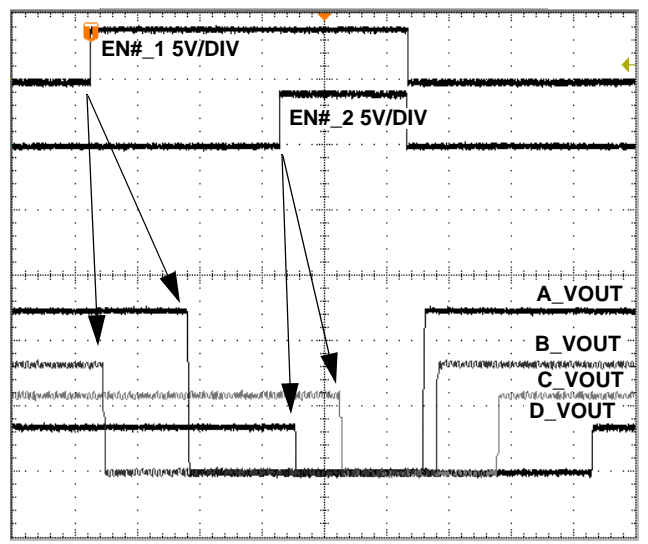

FIGURE 14. ISL6128 GROUP INDEPENDANT TURN-OFF & DELAY ADJUSTABLE PREPROGRAMMED TURN-ON

ISL6123, ISL6124, ISL6125, ISL6126, ISL6127, ISL6128

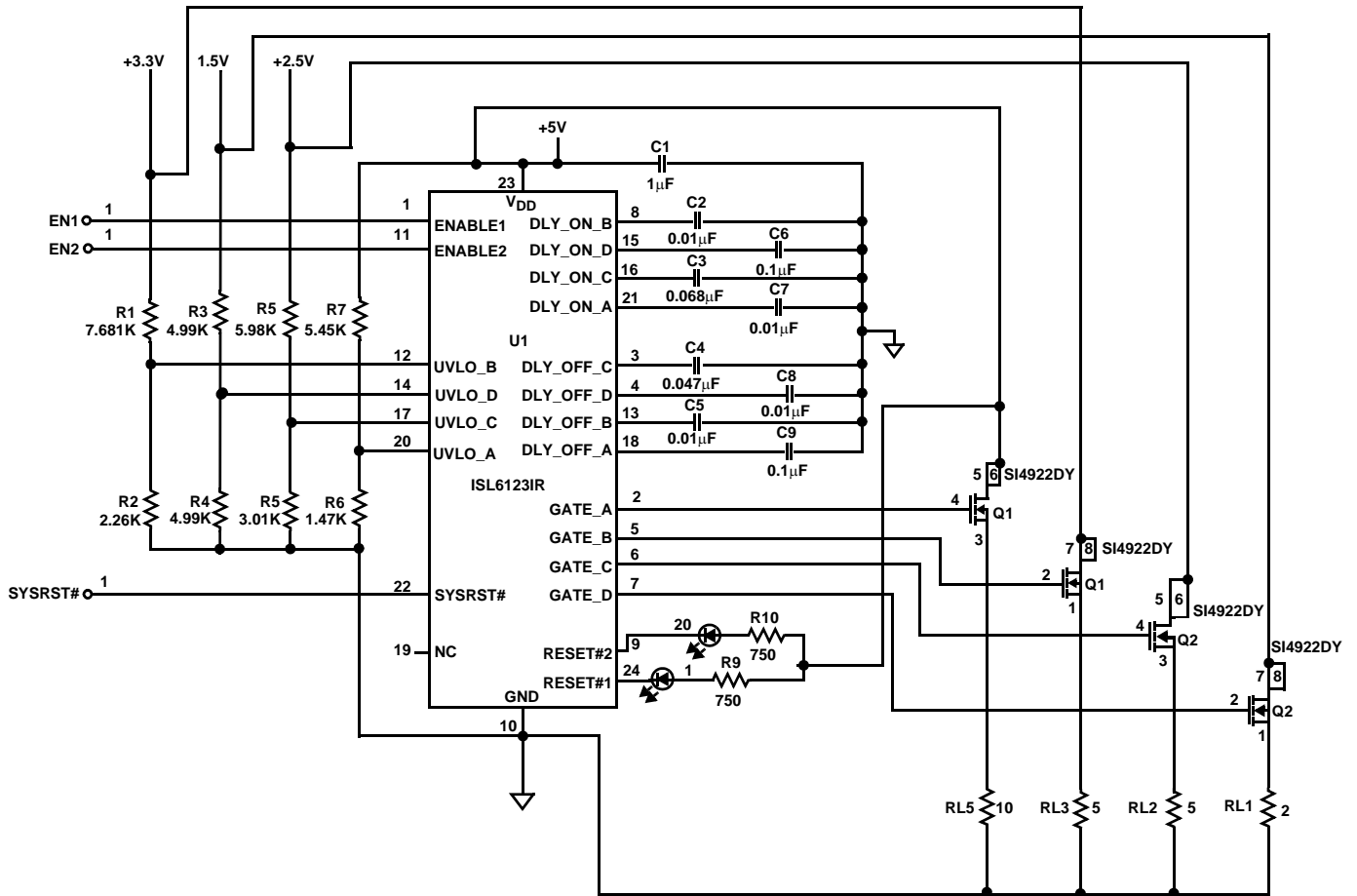

FIGURE 15. EVAL BOARD SCHEMATIC

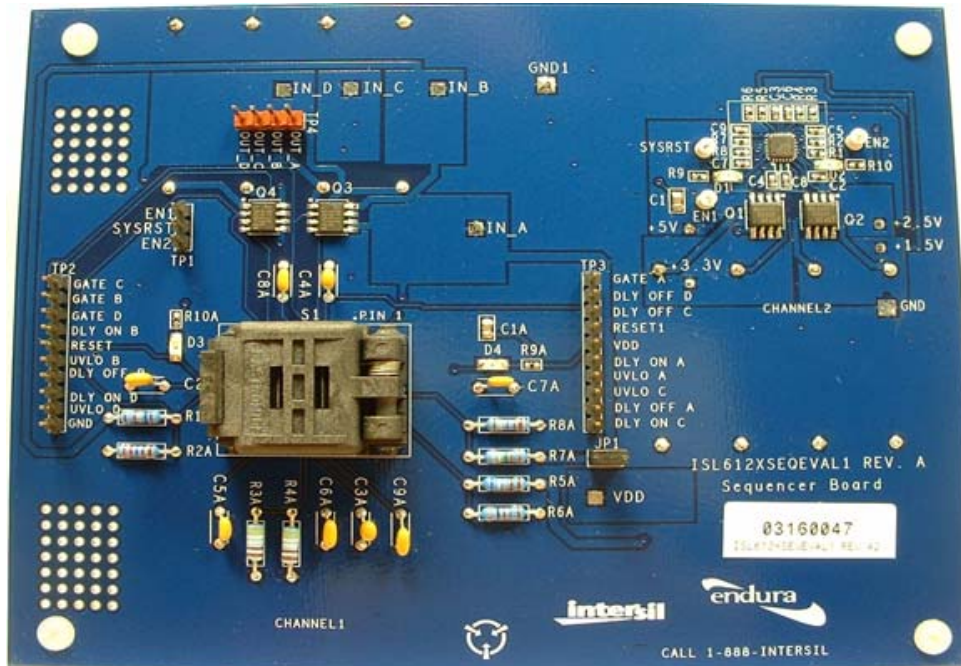

FIGURE 16. EVAL BOARD PHOTOGRAPH

ISL6123, ISL6124, ISL6125, ISL6126, ISL6127, ISL6128

TABLE 2. ISL612XSEQUAL1 BOARD COMPONENT LISTING

COMPONENT DESIGNATOR	COMPONENT FUNCTION	COMPONENT DESCRIPTION
DUT1	ISL6124, 4 Supply Sequencer	Intersil, ISL6124IR 4 Supply Sequencer
Q1, Q2	Voltage Rail Switches	SI4922DY or equiv, Dual 8A, 30V, 0.018 Ω , N-Channel MOSFET
R7	5V to UVLO_A Resistor for Divider String	8.45k Ω 1%, 0402
R8	UVLO_A to GND Resistor for Divider String	1.47k Ω 1%, 0402
R1	3.3V to UVLO_B Resistor for Divider String	7.68k Ω 1%, 0402
R2	UVLO_B to GND Resistor for Divider String	2.26k Ω 1%, 0402
R5	2.5V to UVLO_C Resistor for Divider String	6.98k Ω 1%, 0402
R6	UVLO_C to GND Resistor for Divider String	3.01k Ω 1%, 0402
R3	1.5V to UVLO_D Resistor for Divider String	4.99k Ω 1%, 0402
R4	UVLO_D to GND Resistor for Divider String	4.99k Ω 1%, 0402
R9	RESET#1 LED Current Limiting Resistor	750 Ω 10%, 0805
R10	RESET#2 LED Current Limiting Resistor	750 Ω 10%, 0805
C7	5V turn-on Delay Cap. (13ms)	0.01 μ F 10%, 6.3V, 0402
C9	5V turn-off Delay Cap. (130ms)	0.1 μ F 10%, 6.3V, 0402
C2	3.3V turn-on Delay Cap. (13ms)	0.01 μ F 10%, 6.3V, 0402
C5	3.3V turn-off Delay Cap. (3ms)	0.01 μ F 10%, 6.3V, 0402
C3	2.5V turn-on Delay Cap. (88ms)	0.068 μ F 10%, 6.3V, 0402
C4	2.5V turn-off Delay Cap. (61ms)	0.047 μ F 10%, 6.3V, 0402
C6	1.5V turn-on Delay Cap. (130ms)	0.1 μ F 10%, 6.3V, 0402
C8	1.5V turn-off Delay Cap. (13ms)	0.01 μ F 10%, 6.3V, 0402
C1	Decoupling Capacitor	0.1 μ F, 0805
D1	RESET#1 Indicating LED	0805, SMD LEDs Red
D2	RESET#2 Indicating LED	0805, SMD LEDs Red
TP1 - TP24	Test Points Number Corresponds to DUT Pin Number	
RL5	5V Load Resistor	10 Ω 20%, 3W Carbon
RL3	3.3V Load Resistor	5 Ω 20%, 3W Carbon
RL2	2.5V Load Resistor	5 Ω 20%, 3W Carbon
RL1	1.5V Load Resistor	2 Ω 20%, 3W Carbon

Application Implementations

Multiple Sequencer Implementations

In order to control the sequencing of more than 4 voltages, several of the ISL6123, ISL6124, ISL6125 or ISL6127 devices can be variously configured together to accomplish this. There may be concerns of a particular implementation that would make a particular configuration preferable over another. The fundamental questions to answer to determine which configuration is best suited for your applications are;

1. What level of voltage assurance is needed prior to sequencing on and can the voltage supplies be grouped into high and low criticality?
2. Is there a critical maximum time window all supplies must be present at load or is there a first and a second group preference possibly with some work done in between the two groups of voltages being present?

Three configurations are described and illustrated here.

In applications where the integrity of critical voltages must be assured prior to sequencing, additional monitoring of the critical supplies is needed. If the compliance of the voltage is critical for either under voltage and or over voltage the ISL613X family of supervisors can be employed to provide this additional assurance across multiple sequencers, see document FN9115 for supervisor data sheet. Figure 17 is a block diagram of this voltage compliant, high assurance, low risk configuration showing the ISL613X supervisor and a mix of FET switched outputs and logic output sequencers (ISL6124 and ISL6125 ICs).

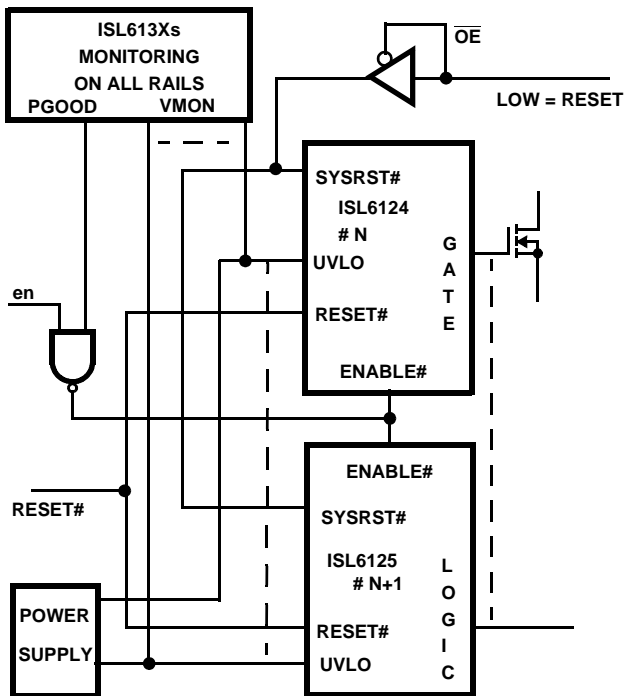

FIGURE 17. ISL612X & ISL613X VOLTAGE COMPLIANT SEQUENCING BLOCK DIAGRAM

If the mere presence of some voltage potential is adequate prior to sequencing on then a small number of standard logic AND gates can be used to accomplish this. The block diagram in Figure 18 illustrates this voltage presence configuration.

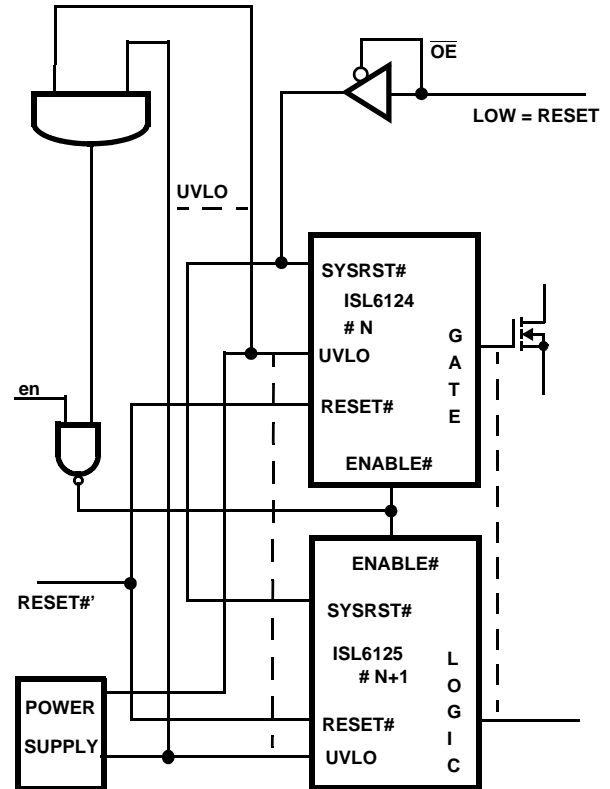

FIGURE 18. MULTIPLE ISL612X USING LOGIC GATES FOR VOLTAGE PRESENCE DETECT

In either case the sequencing is straight forward across multiple sequencers as all DLY_ON capacitors will simultaneously start charging ~10ms after the common ENABLE input signal is delivered. This allows the choice of capacitors to be related to each other no different than using a single sequencer. When the common enabling signal is deasserted these configurations will then execute the turn-off sequence across all sequencers as programmed by the DLY_OFF capacitor values.

In both cases with all the SYSRST# pins bussed together once the on sequence is complete simultaneous shutdown upon any UVLO input failure is assured as SYSRST# output will momentarily pull low turning off all GATE and LOGIC outputs.

There may be applications that require or allow groups of supplies being brought up in sequence and supplies within each group to be sequenced. Figure 19 illustrates such a configuration that allows the first group of supplies to turn-on before the second group starts. This arrangement does not necessarily preclude adding the assurance of all supplies prior to turn-on sequencing as previously shown but it will

ISL6123, ISL6124, ISL6125, ISL6126, ISL6127, ISL6128

prevent the turn-on sequence from completing if there is one unsatisfied UVLO input in a group. Using this configuration involves waiting through the $T_{UVLOdel}$ and T_{RSTdel} (total of ~160ms) for each sequencer IC in the chain for the final RESET# to release. Once ENABLE on the first sequencer is deasserted all the RESET# outputs will quickly pull low and thus allow the sequenced turn-off of this configuration to ripple through several banks as quickly as the user programmed sequence as chosen by the DLY_OFF capacitors allow. Once again with common bussed SYSRST# pins, simultaneous shut down of all GATEs and LOGIC down upon an unsatisfied UVLO input is assured once all FETs or LOGIC output are on.

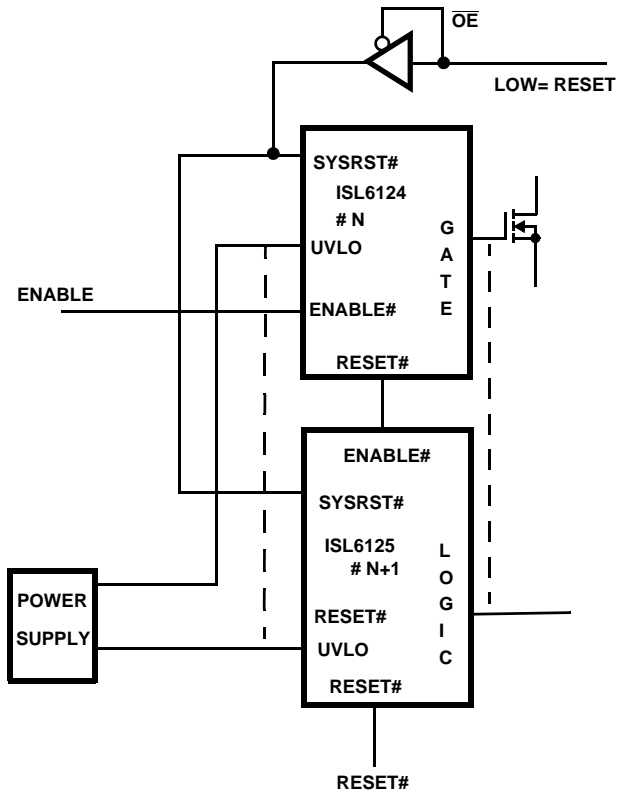

FIGURE 19. MULTIPLE ISL612X SERIAL CONFIGURATION

Voltage Tracking

In some applications the various voltages may have to track each other as they ramp up & down whereas others may just need sequencing. In these cases tracking can be accomplished and has been demonstrated over a wide range of load current (1A to 10A) and load capacitance (10 μ F to 3300 μ F) with the ISL612X family. Figures 20 and 21 illustrate output voltage ramping tracking performance, note that differences are less than 0.5V. With the relevant GATE pins tied together in a star pattern, so that the resistance between any two GATE pins is equivalent (1K to 10K) results in a sharing of the GATE ramping voltage and with the same or similar enough FETs this behavior is observed.

It is suggested that this circuit implementation be prototyped and evaluated for the particular expected loads prior to committing to manufacturing build.

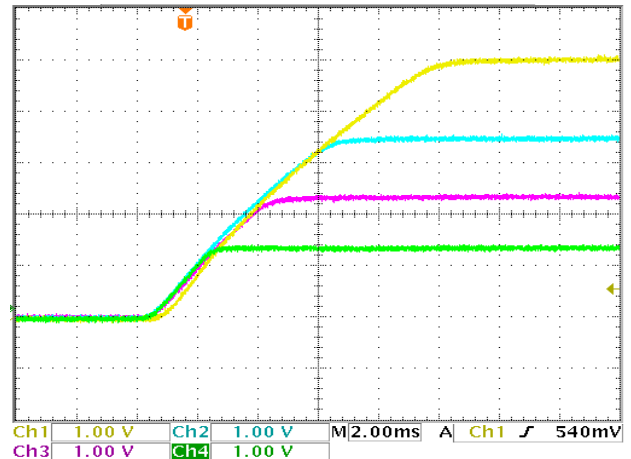

FIGURE 20. OUTPUT VOLTAGE ON LOW TO HIGH TRACKING

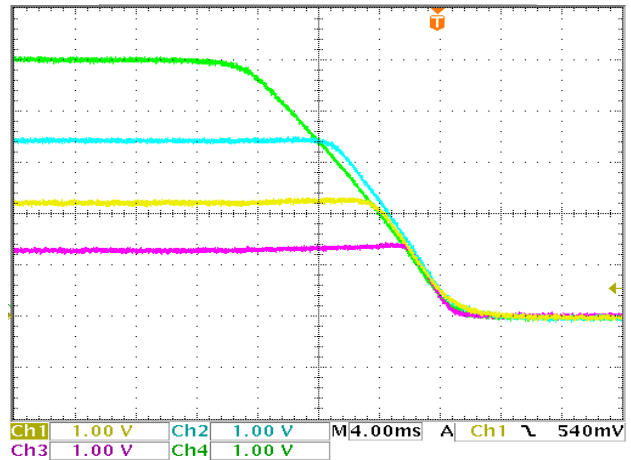

FIGURE 21. OUTPUT VOLTAGE HIGH TO LOW TRACKING

Negative Voltage Sequencing

The ISL612X family can use the charged pump GATE output to drive FETs that would control and sequence negative voltages down to a nominal -5V with minimal additional external circuitry. Figure 22 shows turn-on of 5V bipolar supplies together then the +2.5V and turn-off of both positive supplies being turned off together after the -5V. Figure 23 shows the minimal additional external circuitry to accomplish this. The 5V zener diode is used to level shift the GATE drive down 5V to prevent premature turn-on when GATE = 0V. Once GATE drive voltage > V_z then FET V_{gs} > 5V ensuring full turn-on once GATE gets to $V_{DD}+5.3V$. Turn-on and turn-off ramp rate can be adjusted with FET gate series resistor value. Sequencing of the -V rail is accomplished as normal via the DLY_X capacitor value although adjustments in prototyping should be factored in to fine tune for actual circuit requirements.

ISL6123, ISL6124, ISL6125, ISL6126, ISL6127, ISL6128

Figures 24 and 25 illustrate a high accuracy -V detection circuit using the ISL6131 and a low cost low accuracy -V detect circuit and respectively.

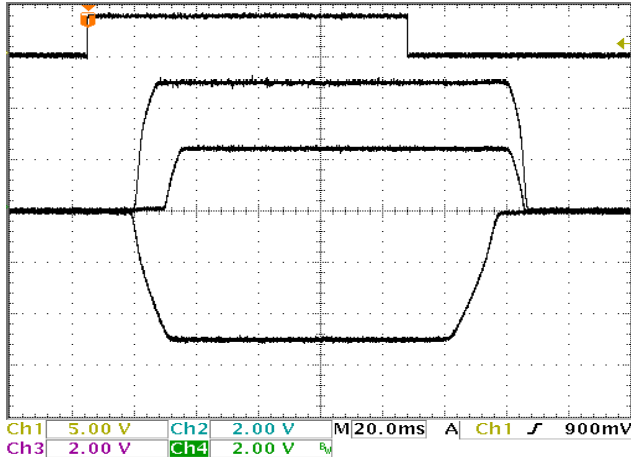
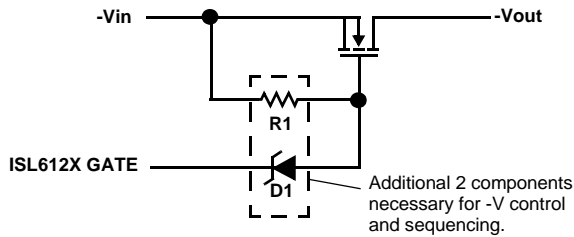
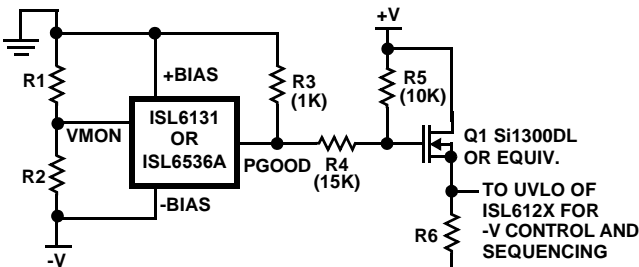

FIGURE 22. ±VOLTAGE SEQUENCING



D1 necessary to prevent premature turn-on. R1 is used to hold FET $V_{gs} = 0V$ until D1 V_z is overcome. R1 value can be changed to adjust -V ramp rates. Choose a R1 value between $4M\Omega$ and $10M\Omega$ initially and fine tune resistor value for the particular need.

FIGURE 23. -VOLTAGE FET DRIVE CIRCUIT



R1 and R2 define -V UVLO level
R3 ensures supervisor (ISL6131 or ISL6536A) PGOOD pull-up
R4 and R5 provide Q1 gate bias between 0V and +V to 0V (resistor values suitable for -V = -5V and +V = +3.3V)

FIGURE 24. HIGH ACCURACY -V LOCK OUT

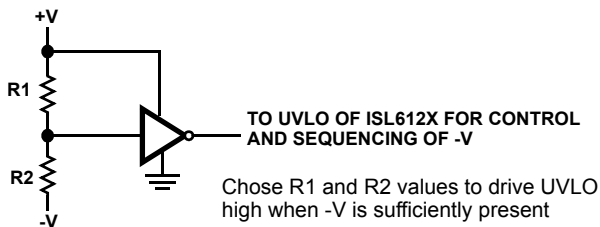

Chose R1 and R2 values to drive UVLO high when -V is sufficiently present

FIGURE 25. LOW ACCURACY -V PRESENCE DETECTION

Application Considerations

Timing Error Sources

In any system there are variance contributors, for the ISL612X family the timing errors are mainly contributed by three sources.

Capacitor Timing Mismatch Error

Obviously, the absolute capacitor value is an error source thus lower percentage tolerance capacitors help to reduce this error source. Figure 26 illustrates a difference of 0.57ms between two DLY_X outputs ramping to DLY_X threshold voltage, these 5% capacitors were from a common source. In applications where two or more GATES or LOGIC outputs must have concurrent transitions, it is recommended that a common DLY_X cap. be used to eliminate this timing error.

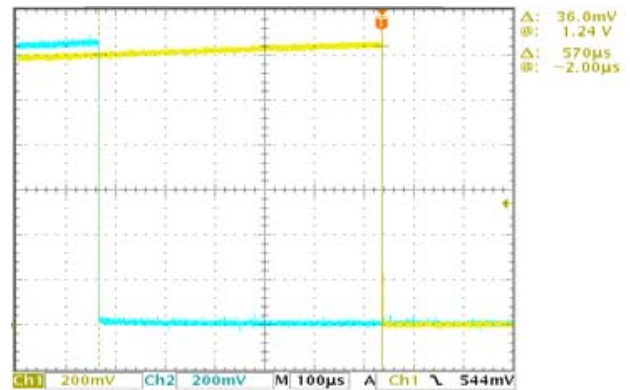

FIGURE 26. CAPACITOR TIMING MISMATCH

DLY_X Threshold Voltage and Charging Current Mismatch

The two other error sources come from the IC itself and are the differences in the DLY_X threshold voltage, (DLY_V_{th}) when the GATE charging latch is set and the DLY_X charging current, (DLY_i_{chg}) across the four individual I/Os. Both of these parameters are bounded by specification and Figure 27 illustrates that with a common capacitor the typical error contributed by these factors is insignificant as both DLY_X traces overlay each other.

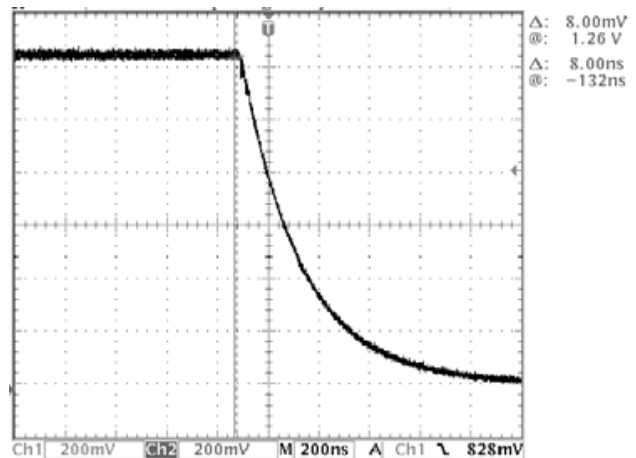
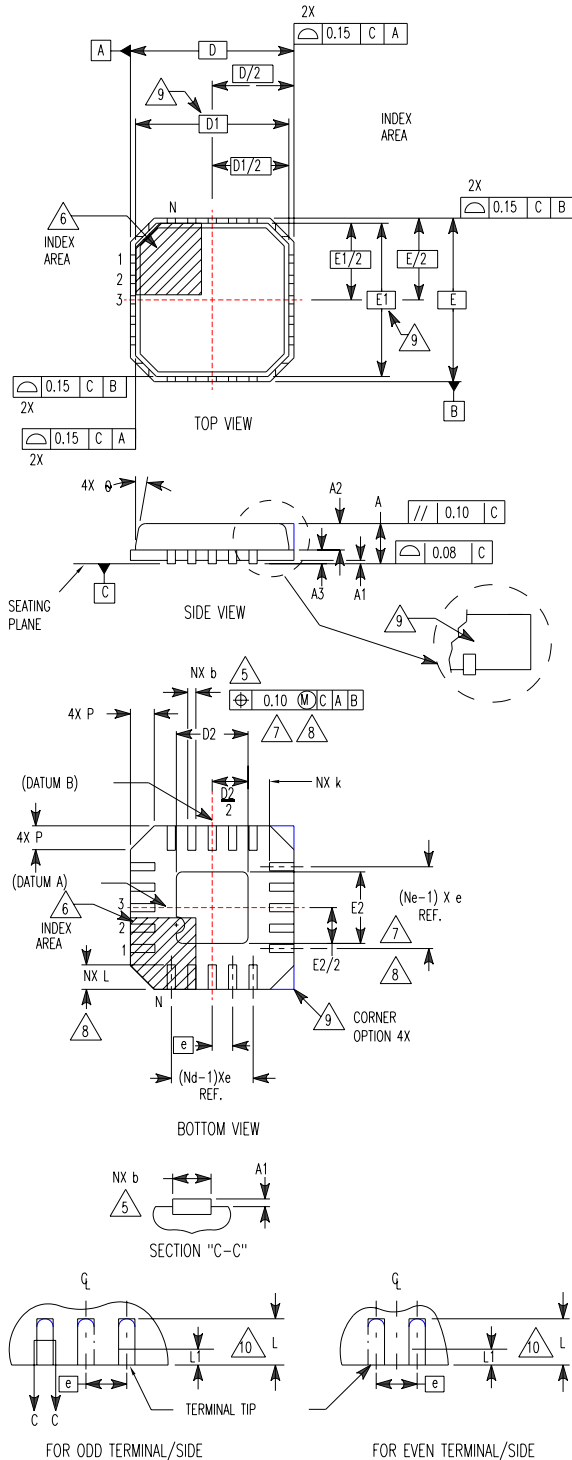

FIGURE 27. DLY_VTH AND DLY_ICHG TIMING MISMATCH

ISL6123, ISL6124, ISL6125, ISL6126, ISL6127, ISL6128

**Quad Flat No-Lead Plastic Package (QFN)
Micro Lead Frame Plastic Package (MLFP)**

**L24.4x4
24 LEAD QUAD FLAT NO-LEAD PLASTIC PACKAGE
(COMPLIANT TO JEDEC MO-220VGGD-2 ISSUE C)**



SYMBOL	MILLIMETERS			NOTES
	MIN	NOMINAL	MAX	
A	0.80	0.90	1.00	-
A1	-	-	0.05	-
A2	-	-	1.00	9
A3	0.20 REF			9
b	0.18	0.23	0.30	5, 8
D	4.00 BSC			-
D1	3.75 BSC			9
D2	1.95	2.10	2.25	7, 8
E	4.00 BSC			-
E1	3.75 BSC			9
E2	1.95	2.10	2.25	7, 8
e	0.50 BSC			-
k	0.25	-	-	-
L	0.30	0.40	0.50	8
L1	-	-	0.15	10
N	24			2
Nd	6			3
Ne	6			3
P	-	-	0.60	9
θ	-	-	12	9

Rev. 2 10/02

NOTES:

1. Dimensioning and tolerancing conform to ASME Y14.5-1994.
2. N is the number of terminals.
3. Nd and Ne refer to the number of terminals on each D and E.
4. All dimensions are in millimeters. Angles are in degrees.
5. Dimension b applies to the metallized terminal and is measured between 0.15mm and 0.30mm from the terminal tip.
6. The configuration of the pin #1 identifier is optional, but must be located within the zone indicated. The pin #1 identifier may be either a mold or mark feature.
7. Dimensions D2 and E2 are for the exposed pads which provide improved electrical and thermal performance.
8. Nominal dimensions are provided to assist with PCB Land Pattern Design efforts, see Intersil Technical Brief TB389.
9. Features and dimensions A2, A3, D1, E1, P & θ are present when Anvil singulation method is used and not present for saw singulation.
10. Depending on the method of lead termination at the edge of the package, a maximum 0.15mm pull back (L1) maybe present. L minus L1 to be equal to or greater than 0.3mm.

All Intersil U.S. products are manufactured, assembled and tested utilizing ISO9000 quality systems.
Intersil Corporation's quality certifications can be viewed at www.intersil.com/design/quality

Intersil products are sold by description only. Intersil Corporation reserves the right to make changes in circuit design, software and/or specifications at any time without notice. Accordingly, the reader is cautioned to verify that data sheets are current before placing orders. Information furnished by Intersil is believed to be accurate and reliable. However, no responsibility is assumed by Intersil or its subsidiaries for its use; nor for any infringements of patents or other rights of third parties which may result from its use. No license is granted by implication or otherwise under any patent or patent rights of Intersil or its subsidiaries.

For information regarding Intersil Corporation and its products, see www.intersil.com