

# ESAC39(C,N,D)(5A)

查询ESAC39供应商

捷多邦, 专业PCB打样工厂, 24小时加急出货

富士小電力ダイオード

## 高速整流ダイオード

### FAST RECOVERY DIODE

## ■外形寸法：Outline Drawings

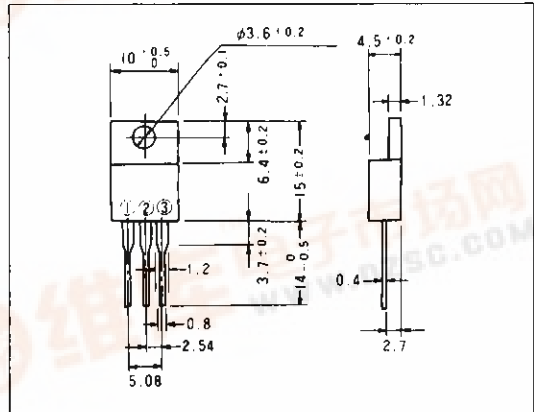

JEDEC	TO-220AB
EIAJ	SC-46

## ■特長：Features

- スイッチングスピードが非常に速い  
Super high speed switching.
- ターンオン電圧が低い  
Low  $V_F$  in turn on
- 高信頼性  
High reliability

## ■用途：Applications

- 高速スイッチング  
High speed switching.

## ■電極接続

### Connection Diagram

ESAC39-□□C	
ESAC39-□□N	
ESAC39-□□D	

## ■定格と特性：Maximum Ratings and Characteristics

### ●絶対最大定格：Absolute Maximum Ratings

Items	Symbols	Conditions	Ratings		Units
			-04	-06	
ピーク繰り返し逆電圧 Repetitive Peak Reverse Voltage	$V_{RRM}$		400	600	V
ピーク非繰り返し逆電圧 Non-Repetitive Peak Reverse Voltage	$V_{RSM}$		400	600	V
平均出力電流 Average Output Current	$I_O$	方形波, duty=1/2, $T_c=115^\circ\text{C}$ Square wave	5*		A
サージ電流 Surge Current	$I_{FSM}$	正弦波 Sine wave 10ms	20		A
接合温度 Operating Junction Temperature	$T_j$		-40~+150		$^\circ\text{C}$
保存温度 Storage Temperature	$T_{stg}$		-40~+150		$^\circ\text{C}$

\*センタータップ平均出力電流

\* average forward current of centertap full wave connection

### ●電気的特性(特に指定がない限り周囲温度 $T_a=25^\circ\text{C}$ とする)

Electrical Characteristics ( $T_a=25^\circ\text{C}$  Unless otherwise specified)

Items	Symbols	Conditions	Max.	Units
順電圧 Forward Voltage Drop	$V_{FM}$	$I_{FM}=2\text{A}$	2.5	V
逆電流 Reverse Current	$I_{RRM}$	$V_R=V_{RRM}$	100	$\mu\text{A}$
逆回復時間 Reverse Recovery Time	$t_{rr}$	$I_F=0.1\text{A}$ , $I_R=0.2\text{A}$ , $I_{rec}=0.05\text{A}$	50	ns
熱抵抗 Thermal Resistance	$R_{th(j-c)}$	接合・ケース間 junction to case	3.0	$^\circ\text{C}/\text{W}$



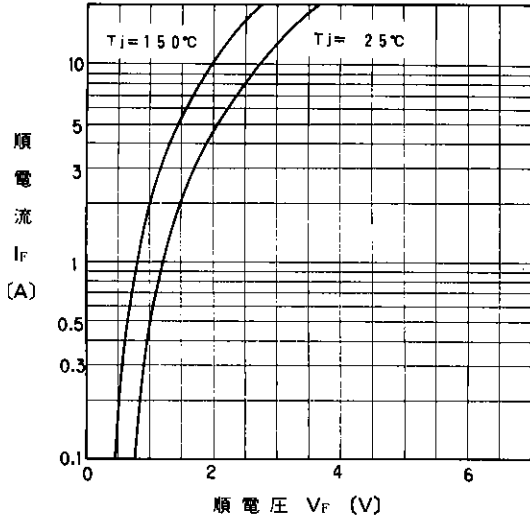

順特性 (代表特性)  
Forward Characteristics

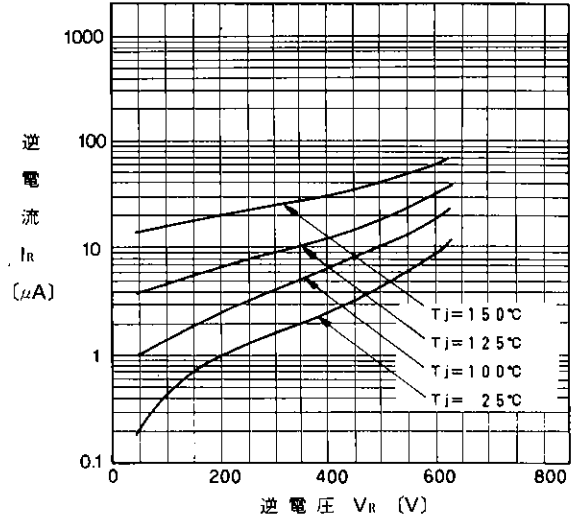

逆特性 (代表特性)  
Reverse Characteristics

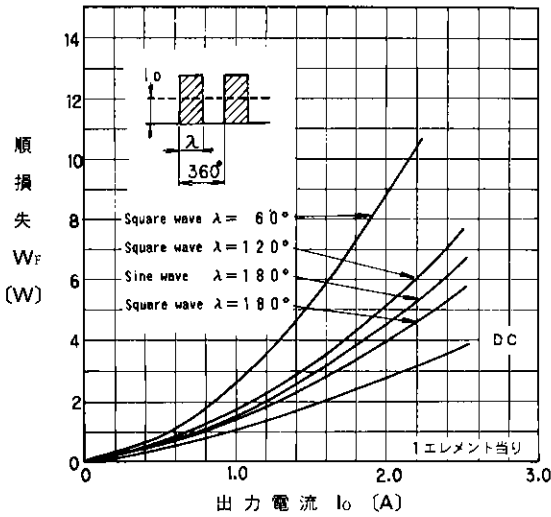

順損失特性  
Forward Power Dissipation

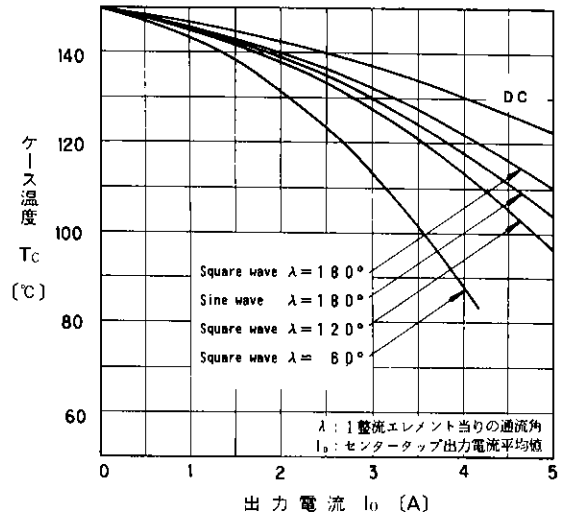

出力電流—ケース温度特性  
Output Current-Case Temperature

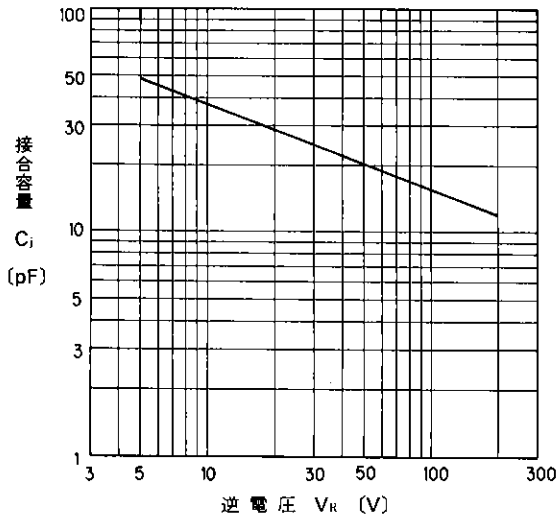

接合容量特性 (代表特性)  
Junction Capacitance

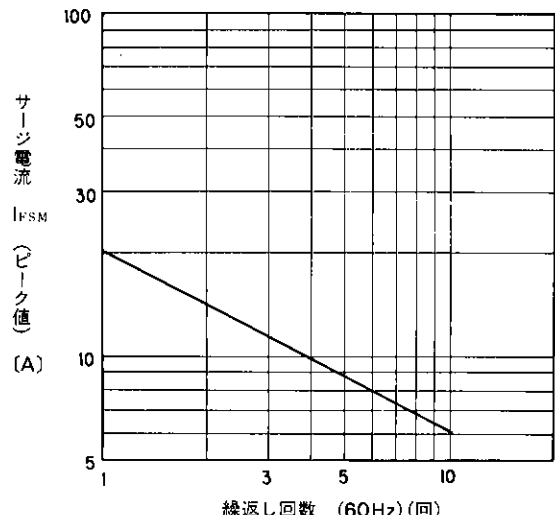

サージ電流耐量  
Surge Capability

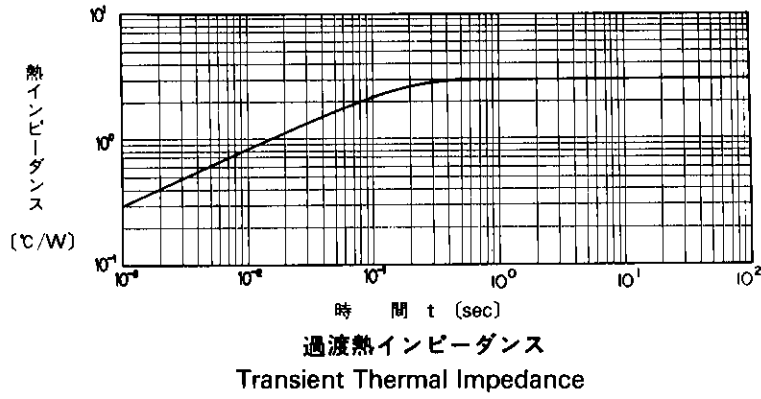

For more information, contact:

**Collmer Semiconductor, Inc.**

P.O. Box 702708

Dallas, TX 75370

972-733-1700

972-381-9991 Fax

<http://www.collmer.com>