



# Low-Cost, Low-Power, 8-Bit DACs with 2-Wire Serial Interface in SOT23

## General Description

The MAX5380/MAX5381/MAX5382 are low-cost, 8-bit digital-to-analog converters (DACs) in miniature 5-pin SOT23 packages, with a simple 2-wire serial interface that allows communication with multiple devices. The MAX5380 has an internal +2V reference and operates from a +2.7V to +3.6V supply. The MAX5381 has an internal +4V reference and operates from a +4.5V to +5.5V supply. The MAX5382 operates over the full +2.7V to +5.5V supply range and has an internal reference equal to  $0.9 \times V_{DD}$ .

The fast-mode I<sup>2</sup>C™-compatible serial interface allows communication at data rates up to 400kbps, minimizing board space and reducing interconnect complexity in many applications. Each device is available with one of four factory-preset addresses (see *Selector Guide*).

These DACs also include an output buffer, a low-power shutdown mode, and a power-on reset that ensures the DAC outputs are at zero when power is initially applied. In shutdown mode, supply current is reduced to less than 1µA and the output is pulled down to GND with a 10kΩ resistor.

## Applications

- Automatic Tuning (VCO)
- Power-Amplifier Bias Control
- Programmable Threshold Levels
- Automatic Gain Control
- Automatic Offset Adjustment

## Typical Operating Circuit

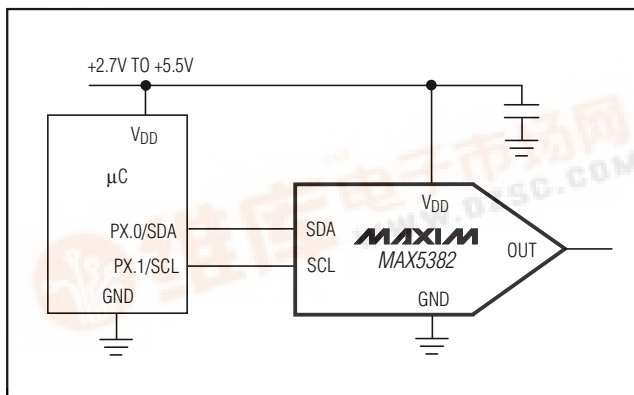

## Features

- ◆ 8-Bit Accuracy in a Miniature 5-Pin SOT23
- ◆ Wide +2.7V to +5.5V Supply Range (MAX5382)
- ◆ Low 230µA max Supply Current
- ◆ 1µA Shutdown Mode
- ◆ Buffered Output Drives Resistive Loads
- ◆ Low-Glitch Power-On Reset to Zero DAC Output
- ◆ Fast I<sup>2</sup>C-Compatible Serial Interface
- ◆ <±5% Full-Scale Error (MAX5382)
- ◆ <±1LSB max INL/DNL

## Ordering Information

PART	TEMP. RANGE	PIN-PACKAGE
MAX5380_EUK-T	-40°C to +85°C	5 SOT23
MAX5381_EUK-T	-40°C to +85°C	5 SOT23
MAX5382_EUK-T	-40°C to +85°C	5 SOT23

## Selector Guide

PART	ADDRESS	REFERENCE (V)	TOP MARK
MAX5380LEUK	0x60	+2.0	ADMN
MAX5380MEUK	0x62	+2.0	ADMZ
MAX5380NEUK	0x64	+2.0	ADFN
MAX5380PEUK	0x66	+2.0	ADMP
MAX5381LEUK	0x60	+4.0	ADMV
MAX5381MEUK	0x62	+4.0	ADNB
MAX5381NEUK	0x64	+4.0	ADNH
MAX5381PEUK	0x66	+4.0	ADML
MAX5382LEUK	0x60	$0.9 \times V_{DD}$	ADMX
MAX5382MEUK	0x62	$0.9 \times V_{DD}$	ADND
MAX5382NEUK	0x64	$0.9 \times V_{DD}$	ADNJ
MAX5382PEUK	0x66	$0.9 \times V_{DD}$	ADNT

## Pin Configuration

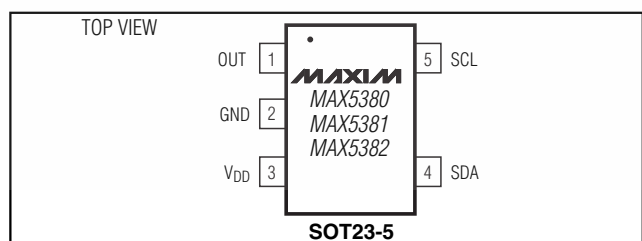

MAX5380/MAX5381/MAX5382

I<sup>2</sup>C is a trademark of Philips Corp.

# Low-Cost, Low-Power, 8-Bit DACs with 2-Wire Serial Interface in SOT23

## ABSOLUTE MAXIMUM RATINGS

V <sub>DD</sub> to GND	-0.3V to +6V
OUT, SCL, SDA to GND	-0.3V to +6V
Maximum Current into Any Pin	50mA
Continuous Power Dissipation (T <sub>A</sub> = +70°C)	
5-Pin SOT23 (derate 7.1mW/°C above +70°C)	571mW

Operating Temperature Ranges	
MAX538_EUK-T	-40°C to +85°C
Storage Temperature Range	-65°C to +150°C
Maximum Junction Temperature	+150°C
Lead Temperature (soldering, 10s)	+300°C

Stresses beyond those listed under "Absolute Maximum Ratings" may cause permanent damage to the device. These are stress ratings only, and functional operation of the device at these or any other conditions beyond those indicated in the operational sections of the specifications is not implied. Exposure to absolute maximum rating conditions for extended periods may affect device reliability.

## ELECTRICAL CHARACTERISTICS

(V<sub>DD</sub> = +2.7V to +3.6V (MAX5380), V<sub>DD</sub> = +4.5V to +5.5V (MAX5381), V<sub>DD</sub> = +2.7V to +5.5V (MAX5382); R<sub>L</sub> = 10kΩ; C<sub>L</sub> = 50pF, T<sub>A</sub> = T<sub>MIN</sub> to T<sub>MAX</sub>, unless otherwise noted. Typical values are T<sub>A</sub> = +25°C.)

PARAMETER	SYMBOL	CONDITIONS	MIN	TYP	MAX	UNITS
<b>STATIC ACCURACY</b>						
Resolution			8			Bits
Integral Linearity Error	INL	(Note 1)			±1	LSB
Differential Linearity Error	DNL	Guaranteed monotonic			±1	LSB
Offset Error		(Note 2)		±1	±25	mV
Offset Error Supply Rejection		MAX5382 (Notes 2, 3)	60			dB
Offset Error Temperature Coefficient		(Note 2)		3		ppm/°C
		MAX5380/MAX5381				
Full-Scale Error		Code = 255	MAX5380/MAX5381		10	% of ideal FS
			MAX5382		5	
Full-Scale Error Supply Rejection		Code = 255, MAX5380/MAX5281 (Note 4)			50	dB
Full-Scale Error Temperature Coefficient		Code = 255	MAX5380/MAX5381		±40	ppm/°C
			MAX5382		±10	
<b>DAC OUTPUT</b>						
Internal Reference (Note 5)	REF	MAX5380	1.8	2	2.2	V
		MAX5381	3.6	4	4.4	
		MAX5382	0.85 x V <sub>DD</sub>	0.9 x V <sub>DD</sub>	0.95 x V <sub>DD</sub>	
Output Load Regulation		Code = 255, 0 to 100μA		0.5		LSB
		Code = 0, 0 to 100μA		0.5		
Output Resistance		V <sub>OUT</sub> = 0 to V <sub>DD</sub> , power-down mode		10		kΩ
<b>DYNAMIC PERFORMANCE</b>						
Voltage Output Slew Rate		Positive and negative		0.4		V/μs
Output Settling Time		To 1/2 LSB, 50kΩ and 50pF load (Note 6)		20		μs
Digital Feedthrough		Code = 0, all digital inputs from 0 to V <sub>DD</sub>		2		nVs
Digital-Analog Glitch Impulse		Code 127 to 128		40		nVs
Wake-Up Time		From software shutdown		50		μs

# Low-Cost, Low-Power, 8-Bit DACs with 2-Wire Serial Interface in SOT23

MAX5380/MAX5381/MAX5382

## ELECTRICAL CHARACTERISTICS (continued)

( $V_{DD} = +2.7V$  to  $+3.6V$  (MAX5380),  $V_{DD} = +4.5V$  to  $+5.5V$  (MAX5381),  $V_{DD} = +2.7V$  to  $+5.5V$  (MAX5382);  $R_L = 10k\Omega$ ;  $C_L = 50pF$ ,  $T_A = T_{MIN}$  to  $T_{MAX}$ , unless otherwise noted. Typical values are  $T_A = +25^\circ C$ .)

PARAMETER	SYMBOL	CONDITIONS	MIN	TYP	MAX	UNITS
<b>POWER REQUIREMENTS</b>						
Supply Voltage	$V_{DD}$	MAX5380	2.7		3.6	V
		MAX5381	4.5		5.5	
		MAX5382	2.7		5.5	
Supply Current	$I_{DD}$	No load, all digital inputs at 0 or $V_{DD}$ , code = 255		150	230	$\mu A$
		Shutdown mode			1	
<b>DIGITAL INPUTS (SCL, SDA)</b>						
Input Low Voltage	$V_{IL}$				$0.3 \times V_{DD}$	V
Input High Voltage	$V_{IH}$		$0.7 \times V_{DD}$			V
Input Hysteresis	$V_{HYS}$			$0.05 \times V_{DD}$		V
Input Capacitance	$C_{IN}$	(Note 7)		10		pF
Input Leakage Current	$I_{IN}$				$\pm 10$	$\mu A$
Pulse Width of Spike Suppressed	$t_{SP}$		0		50	ns
<b>DIGITAL OUTPUT (SDA, open drain)</b>						
Output Low Voltage	$V_{OL}$	$I_{SINK} = 3mA$			0.4	V
		$I_{SINK} = 6mA$			0.6	
Output Fall Time	$t_{OF}$	$V_{IH(MIN)}$ to $V_{IL(MAX)}$ , bus capacitance = 10pF to 400pF	$I_{SINK} = 3mA$		250	ns
			$I_{SINK} = 6mA$		250	

## TIMING CHARACTERISTICS

(Figure 3;  $V_{DD} = +2.7V$  to  $+3.6V$  (MAX5380),  $V_{DD} = +4.5V$  to  $+5.5V$  (MAX5381),  $V_{DD} = +2.7V$  to  $+5.5V$  (MAX5382);  $R_L = 10k\Omega$ ;  $C_L = 50pF$ ,  $T_A = T_{MIN}$  to  $T_{MAX}$ , unless otherwise noted. Typical values are  $T_A = +25^\circ C$ .) (Note 7)

PARAMETER	SYMBOL	CONDITIONS	MIN	TYP	MAX	UNITS
SCL Clock Frequency	$f_{SCL}$		0		400	kHz
Bus Free Time Between a STOP and a START Condition	$t_{BUF}$		1.3			$\mu s$
Hold Time Repeated for a START Condition	$t_{HD:STA}$		0.6			$\mu s$
Low Period of the SCL Clock	$t_{LOW}$		1.3			$\mu s$
High Period of the SCL Clock	$t_{HIGH}$		0.6			$\mu s$
Setup Time for a Repeated START Condition	$t_{SU:STA}$		0.6			$\mu s$
Data Hold Time	$t_{HD:DAT}$		0		0.9	$\mu s$
Data Setup Time	$t_{SU:DAT}$		100			ns

## Low-Cost, Low-Power, 8-Bit DACs with 2-Wire Serial Interface in SOT23

### TIMING CHARACTERISTICS (continued)

(Figure 3;  $V_{DD} = +2.7V$  to  $+3.6V$  (MAX5380),  $V_{DD} = +4.5V$  to  $+5.5V$  (MAX5381),  $V_{DD} = +2.7V$  to  $+5.5V$  (MAX5382);  $R_L = 10k\Omega$ ;  $C_L = 50pF$ ,  $T_A = T_{MIN}$  to  $T_{MAX}$ , unless otherwise noted. Typical values are  $T_A = +25^\circ C$ .) (Note 7)

PARAMETER	SYMBOL	CONDITIONS	MIN	TYP	MAX	UNITS
Rise Time of Both SDA and SCL Signals	$t_r$				300	ns
Fall Time of Both SDA and SCL Signals	$t_f$				300	ns
Setup Time for STOP Condition	$t_{SU:STO}$		0.6			$\mu s$
Capacitive Load for Each Bus Line	$C_b$				400	pF

**Note 1:** Guaranteed from code 5 to code 255.

**Note 2:** The offset value extrapolated from the range over which the INL is guaranteed.

**Note 3:** MAX5382 tested at  $V_{DD} = +5V \pm 10\%$ .

**Note 4:** MAX5380 tested at  $V_{DD} = +3V \pm 10\%$ , MAX5381 tested at  $V_{DD} = 5V \pm 10\%$ .

**Note 5:** Actual output voltages at full scale are  $255/256 \times V_{REF}$ .

**Note 6:** Output settling time is measured by taking the code from code 5 to 255, and from code 255 to 5.

**Note 7:** Guaranteed by design.

### Typical Operating Characteristics

( $V_{DD} = +3.0V$  (MAX5380),  $V_{DD} = +5.0V$  (MAX5381/MAX5382);  $R_L = 10k\Omega$ ,  $T_A = +25^\circ C$ , unless otherwise noted.)

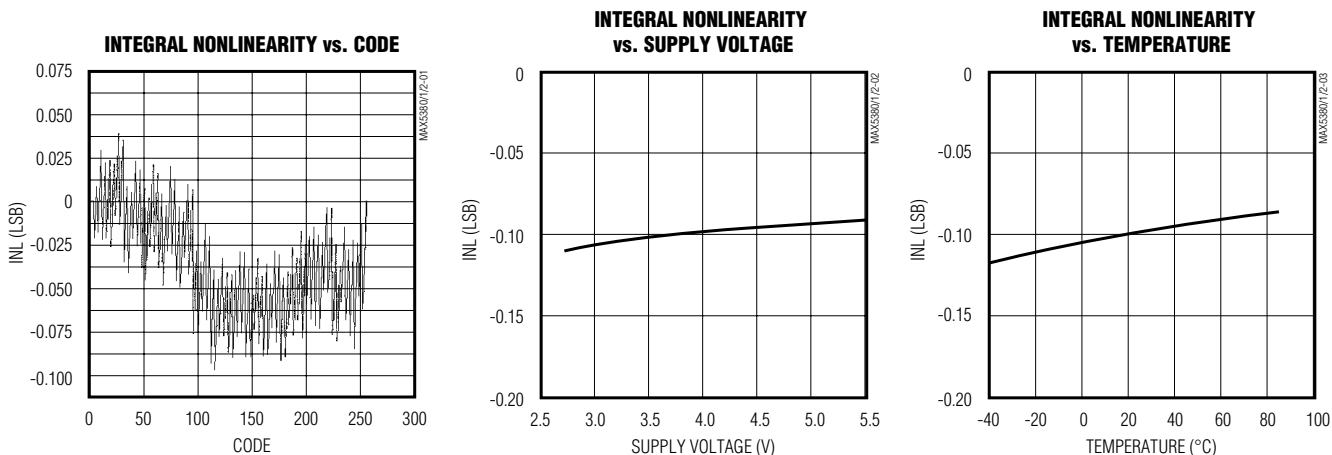

# Low-Cost, Low-Power, 8-Bit DACs with 2-Wire Serial Interface in SOT23

## Typical Operating Characteristics (continued)

(V<sub>DD</sub> = +3.0V (MAX5380), V<sub>DD</sub> = +5.0V (MAX5381/MAX5382); R<sub>L</sub> = 10kΩ, T<sub>A</sub> = +25°C, unless otherwise noted.)

MAX5380/MAX5381/MAX5382

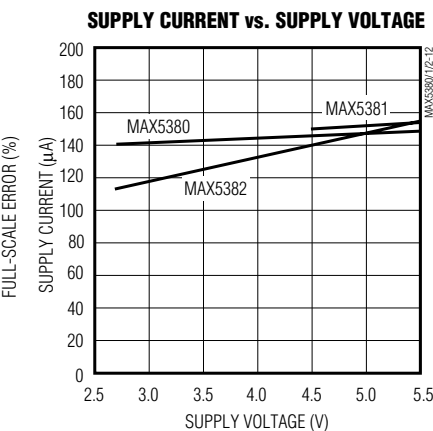
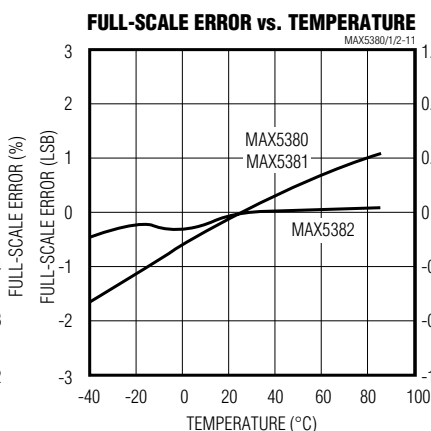
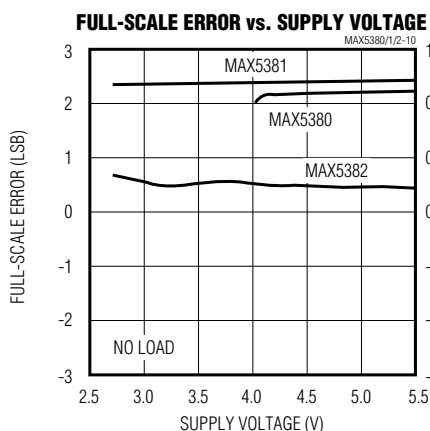
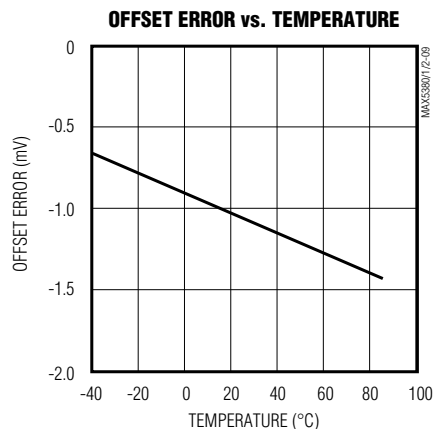
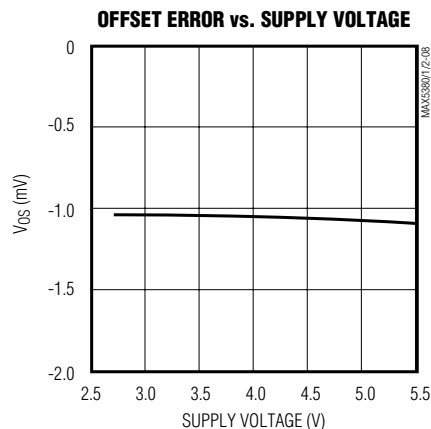
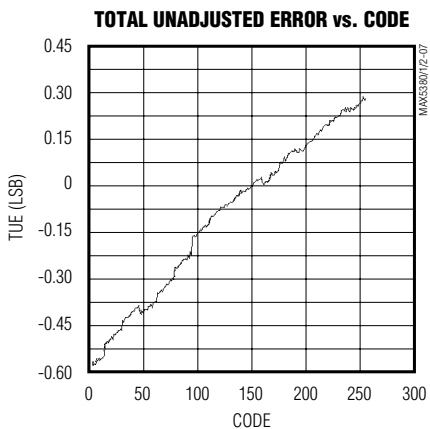
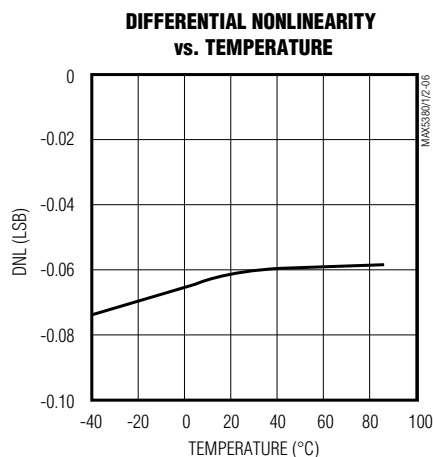
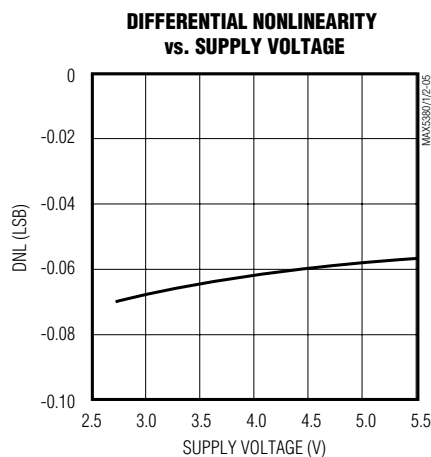
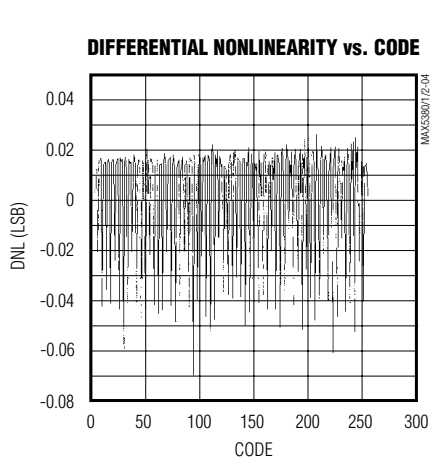

# Low-Cost, Low-Power, 8-Bit DACs with 2-Wire Serial Interface in SOT23

## Typical Operating Characteristics (continued)

( $V_{DD} = +3.0V$  (MAX5380),  $V_{DD} = +5.0V$  (MAX5381/MAX5382);  $R_L = 10k\Omega$ ,  $T_A = +25^\circ C$ , unless otherwise noted.)

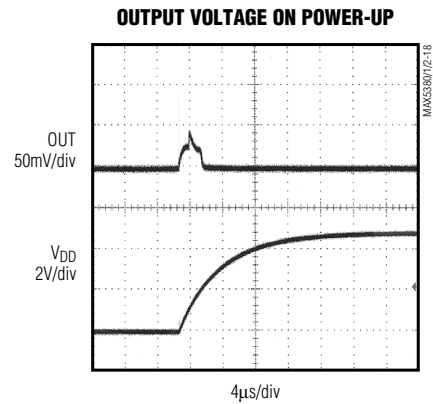
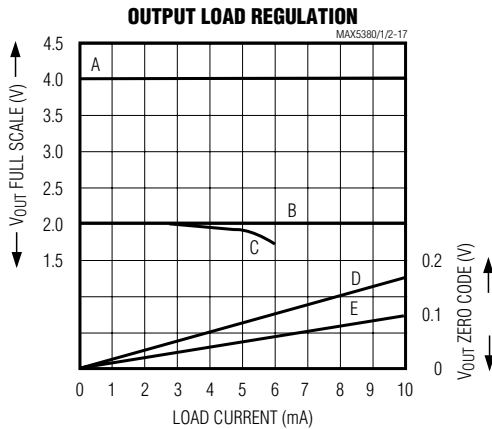
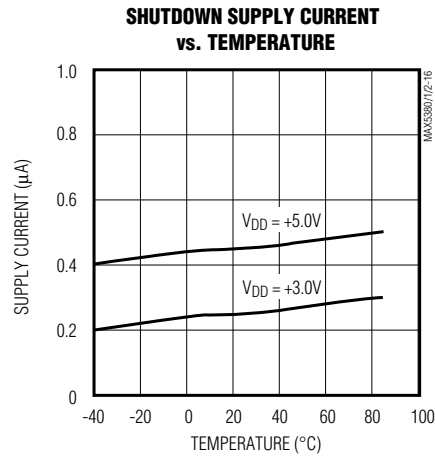
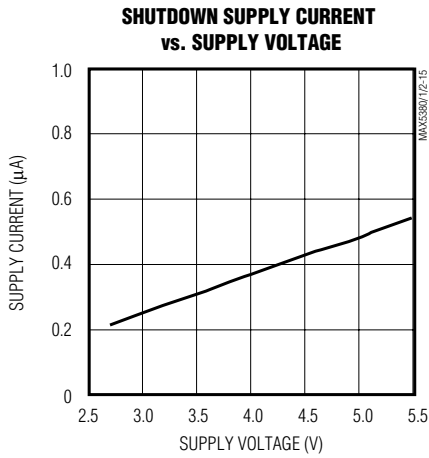
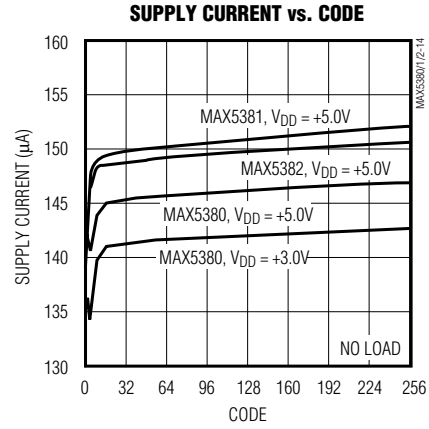
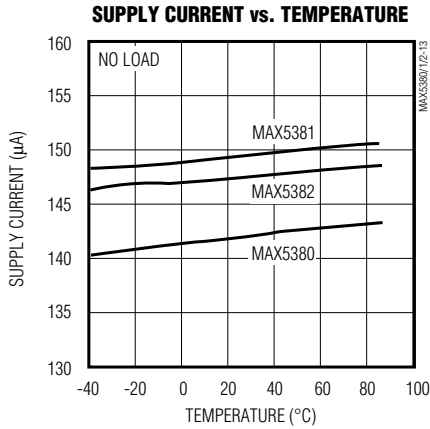

- A: MAX5361/MAX5362,  $V_{DD} = 4.5V$  FULL-SCALE OR SOURCING  
 B: MAX5360, FULL-SCALE,  $V_{DD} = 2.7V$  SINKING,  $V_{DD} = 5.0V$  SOURCING  
 C: MAX5360, FULL-SCALE,  $V_{DD} = 2.7V$  SOURCING  
 D: ZERO CODE,  $V_{DD} = 2.7V$  SINKING  
 E: ZERO CODE,  $V_{DD} = 5.5V$  SINKING

# Low-Cost, Low-Power, 8-Bit DACs with 2-Wire Serial Interface in SOT23

## Typical Operating Characteristics (continued)

( $V_{DD} = +3.0V$  (MAX5380),  $V_{DD} = +5.0V$  (MAX5381/MAX5382);  $R_L = 10k\Omega$ ,  $T_A = +25^\circ C$ , unless otherwise noted.)

MAX5380/MAX5381/MAX5382

**OUTPUT VOLTAGE EXITING SHUTDOWN**

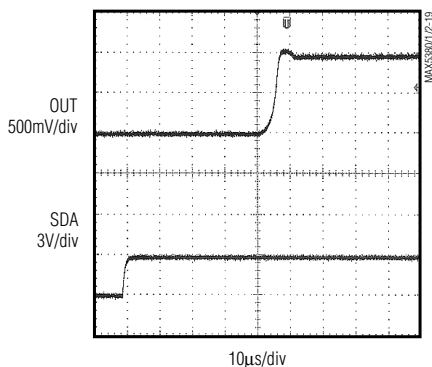

MAX5380, SHDN TO 0x80

**OUTPUT VOLTAGE ENTERING SHUTDOWN**

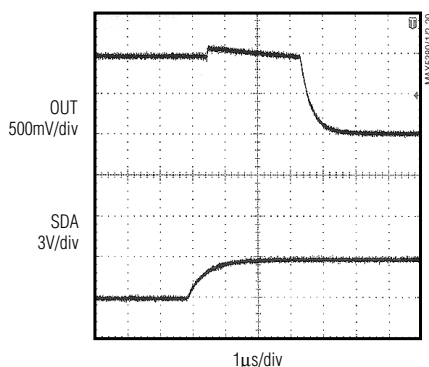

MAX5380, 0x80 TO SHDN

**OUTPUT SETTLING FROM 1/4 FS TO 3/4 FS**

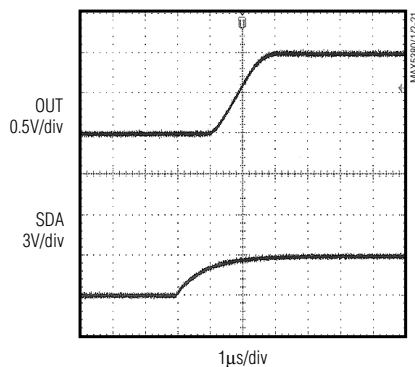

MAX5380

**OUTPUT SETTLING FROM 3/4 FS TO 1/4 FS**

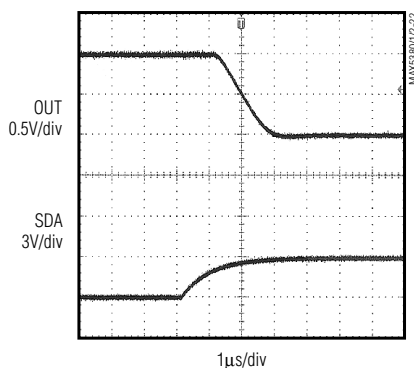

MAX5380

**OUTPUT SETTLING 1LSB STEP UP**

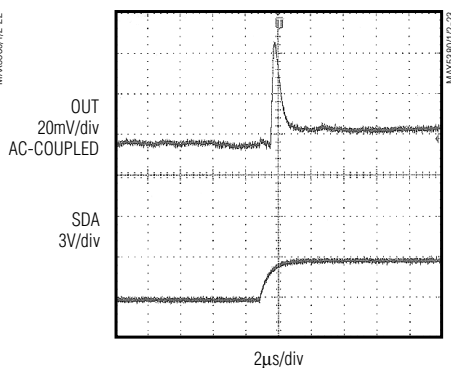

MAX5380, 0x7F TO 0x80

**OUTPUT SETTLING 1LSB STEP DOWN**

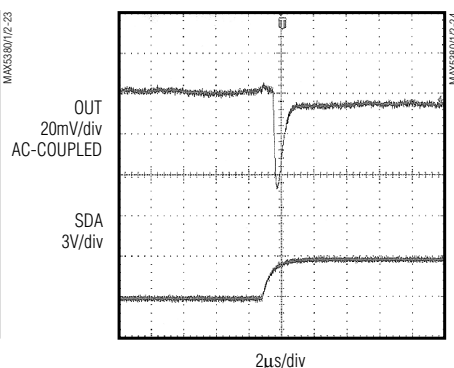

MAX5380, 0x80 TO 0x7F

## Pin Description

PIN	NAME	FUNCTION
1	OUT	DAC Voltage Output
2	GND	Ground
3	$V_{DD}$	Power-Supply Input
4	SDA	Serial Data Input
5	SCL	Serial Clock Input

# Low-Cost, Low-Power, 8-Bit DACs with 2-Wire Serial Interface in SOT23

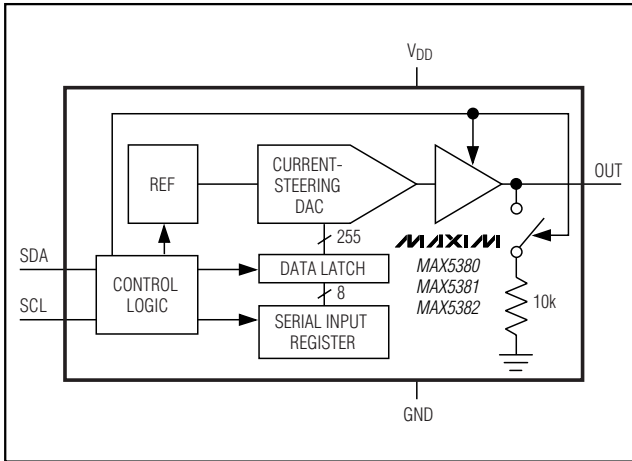

Figure 1. Functional Diagram

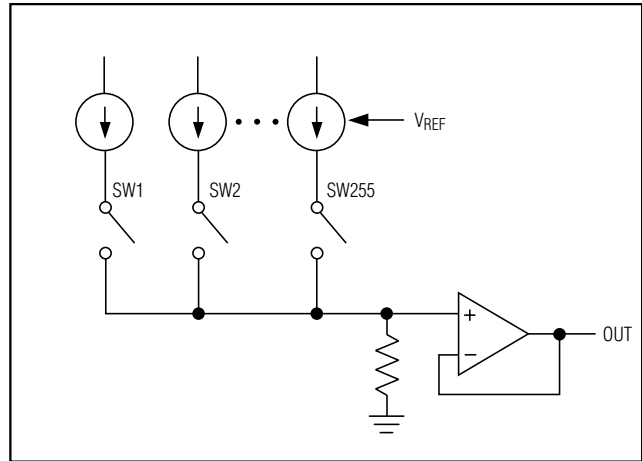

Figure 2. Current-Steering Topology

**Table 1. Unipolar Code Output Voltage**

DAC CODE	OUTPUT VOLTAGE		
	MAX5380	MAX5381	MAX5382
1111 1111	$2V \times (255 / 256)$	$4V \times (255 / 256)$	$0.9 \times V_{DD} \times (255 / 256)$
1000 0000	+1V	+2V	$0.9 \times V_{DD} / 2$
0000 0001	7.8mV	15.6mV	$0.9 \times V_{DD} / 256$
0000 0000	0	0	0

## Detailed Description

The MAX5380/MAX5381/MAX5382 voltage-output, 8-bit digital-to-analog converters (DACs) offer full 8-bit performance with less than 1LSB integral nonlinearity error and less than 1LSB differential nonlinearity error, ensuring monotonic performance. The devices use a simple 2-wire, fast-mode I<sup>2</sup>C-compatible serial interface that operates at up to 400kHz. The MAX5380/MAX5381/MAX5382 include an internal reference, an output buffer, and a low-current shutdown mode, which make these devices ideal for low-power, highly integrated applications (See Figure 1. *Functional Diagram*).

## Analog Section

The MAX5380/MAX5381/MAX5382 employ a current-steering DAC topology as shown in Figure 2. At the core of the DAC is a reference voltage-to-current converter (V/I) that generates a reference current. This current is mirrored to 255 equally weighted current sources. DAC switches control the outputs of these current mirrors so that only the desired fraction of the total current-mirror

currents is steered to the DAC output. The current is then converted to a voltage across a resistor, and this voltage is buffered by the output buffer amplifier.

## Output Voltage

Table 1 shows the relationship between the DAC code and the analog output voltage. The 8-bit DAC code is binary unipolar with  $1\text{LSB} = V_{\text{REF}} / 256$ . The MAX5380/MAX5381 have a full-scale output voltage of (+2V - 1LSB) and (+4V - 1LSB), respectively, set by the internal references. The MAX5382 has a full-scale output voltage of  $(0.9 \times V_{DD} - 1\text{LSB})$ .

## Output Buffer

The DAC voltage output is an internally buffered unity-gain follower that typically slews at  $\pm 0.4V/\mu\text{s}$ . The output can swing from 0 to full scale. With a 1/4 FS to 3/4 FS output transition, the amplifier outputs typically settle to 1/2LSB in less than 5 $\mu\text{s}$  when loaded with 10k $\Omega$  in parallel with 50pF. The buffer amplifiers are stable with any combination of resistive loads >10k $\Omega$  and capacitive loads <50pF.



## Low-Cost, Low-Power, 8-Bit DACs with 2-Wire Serial Interface in SOT23

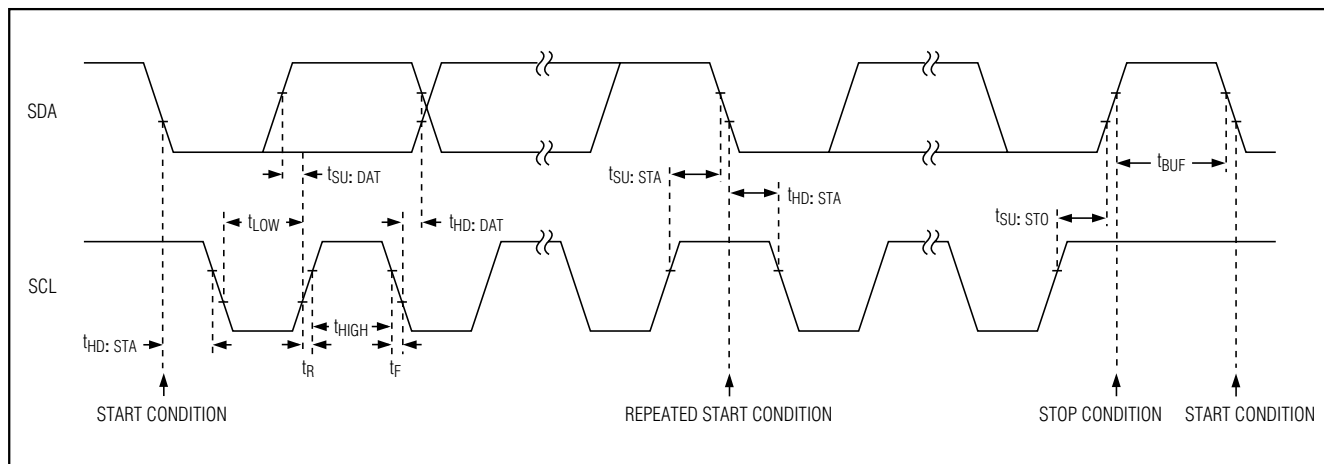

Figure 3. 2-Wire Serial Interface Timing Diagram

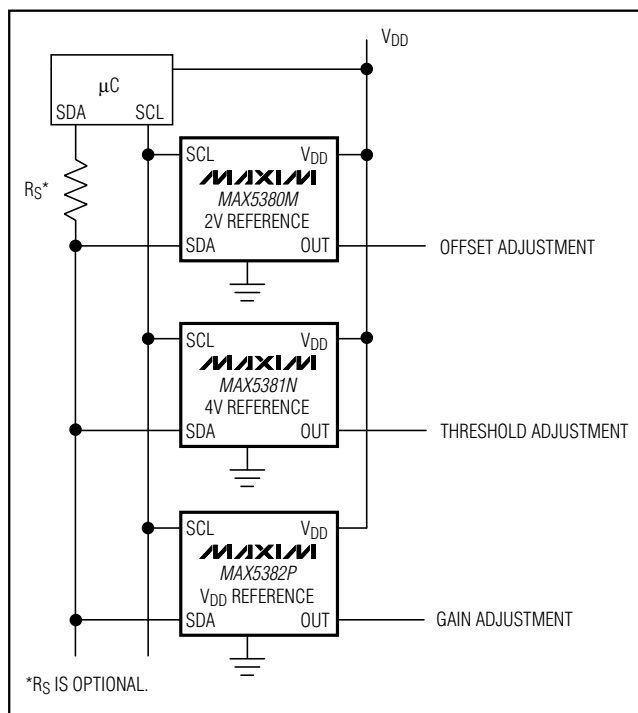

Figure 4. Typical Application Circuit

### Power-On Reset

The MAX5380/MAX5381/MAX5382 have a power-on reset circuit to set the DAC's output to 0 when V<sub>DD</sub> is first applied or when V<sub>DD</sub> dips below 1.7V (typ). This ensures that unwanted DAC output voltages will not occur immediately following a system startup, such as

after a loss of power. The output glitch at startup is typically less than 50mV.

### Shutdown Mode

The MAX5380/MAX5381/MAX5382 include a software-controlled shutdown mode that reduces the supply current to <1µA. All internal circuitry is disabled, and an internal 10kΩ resistor is placed from OUT to GND to ensure 0V at OUT while in shutdown. The device enters shutdown in less than 5µs and exits shutdown in less than 50µs.

### Digital Section

#### Serial Interface

The MAX5380/MAX5381/MAX5382 use a simple 2-wire serial interface requiring only two I/O lines (2-wire bus) of a standard microprocessor (µP) port. Figure 3 shows the timing diagram for signals on the 2-wire bus.

The two bus lines (SDA and SCL) must be high when the bus is not in use. The MAX5380/MAX5381/MAX5382 are receive-only devices (slaves) and must be controlled by a bus master device. Figure 4 shows a typical application where up to four devices can be connected to the bus, provided they have different address settings. External pull-up resistors are not necessary on these lines (when driven by push-pull drivers), though these DACs can be used in applications where pull-up resistors are required (such as in I<sup>2</sup>C systems) to maintain compatibility with existing circuitry. The serial interface operates at SCL rates up to 400kHz. The SDA state is allowed to change only while SCL is low, with the exception of START and STOP conditions as shown in Figure 5. Each transmission consists of a START condition sent by the bus master

# Low-Cost, Low-Power, 8-Bit DACs with 2-Wire Serial Interface in SOT23

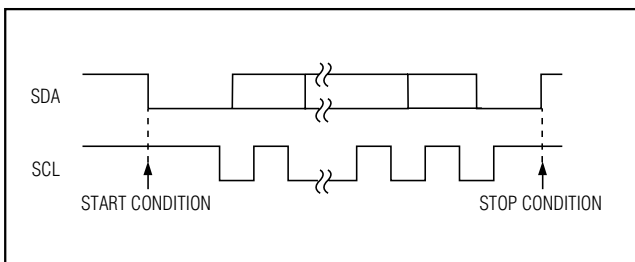

Figure 5. START and STOP Conditions

device, followed by the MAX5380/MAX5381/MAX5382s' preset slave address, a power-mode bit, the DAC data, and finally, a STOP condition (Figure 6). The bus is then free for another transmission.

SDA's state is sampled and therefore must remain stable while SCL is high. Data is transmitted in 8-bit bytes. Nine clock cycles are required to transfer each byte to the MAX5380/MAX5381/MAX5382. Release SDA during the 9th clock cycle since the selected device acknowledges receipt of the byte by pulling SDA low during this time. A series resistor on the SDA line may be needed if the master's output is forced high while the selected device acknowledges (Figure 4).

### Slave Address

The MAX5380/MAX5381/MAX5382 are available with one of four preset slave addresses. Each address option is identified by the suffix L, M, N, or P added to the part number. The address is defined as the 7MSBs sent by the master after a START condition. The address options are 0x60, 0x62, 0x64, 0x66 (left justified with LSB set to 0). The 8th bit, typically used to

define a write or read protocol, sets the device's power mode (SHDN). The device is powered-down when SHDN is set to one. During a device search routine, the MAX5380/MAX5381/MAX5382 acknowledge both options (SHDN = 0 or SHDN = 1), but do not change their power state if a stop condition (or restart) is issued immediately. The second byte (DAC data) must be sent/received for the device to update both power mode and DAC output.

### DAC Data

The 8-bit DAC data is decoded as straight binary MSB first with 1LSB =  $V_{REF} / 256$  and converted into the corresponding analog voltage as shown in Table 1. After receiving the data byte, the devices acknowledge its receipt and expect a STOP condition, at which point the DAC output is updated.

The MAX5380/MAX5381/MAX5382 update the output and the power mode only if the second byte is clocked in (SHDN = 0) or out (SHDN = 1) of the device. When SHDN = 1, the master will read all ones when clocking out a data byte. The MAX5380/MAX5381/MAX5382 do not drive SDA except for the acknowledge bit.

### I<sup>2</sup>C Compatibility

The MAX5380/MAX5381/MAX5382 are compatible with existing I<sup>2</sup>C systems. SCL and SDA are high-impedance inputs; SDA has an open drain that pulls the data line low during the 9th clock pulse. Figure 7 shows a typical I<sup>2</sup>C application. The communication protocol supports standard I<sup>2</sup>C 8-bit communications. The general call address is ignored, and CBUS formats are not supported. The devices' address is compatible with the 7-bit I<sup>2</sup>C addressing protocol only. No 10-bit formats

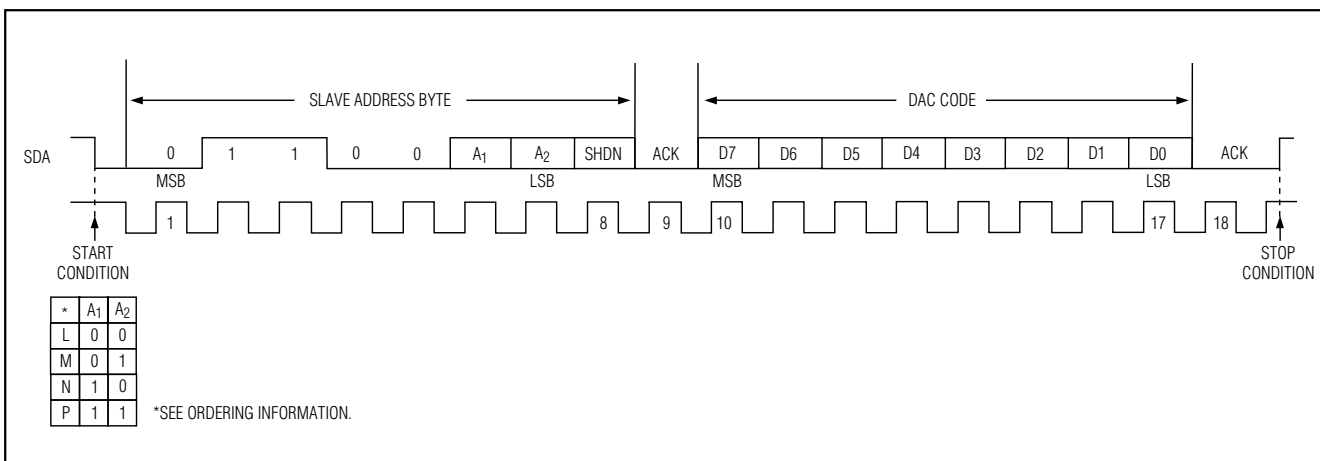

Figure 6. A Complete Serial Transmission

# Low-Cost, Low-Power, 8-Bit DACs with 2-Wire Serial Interface in SOT23

MAX5380/MAX5381/MAX5382

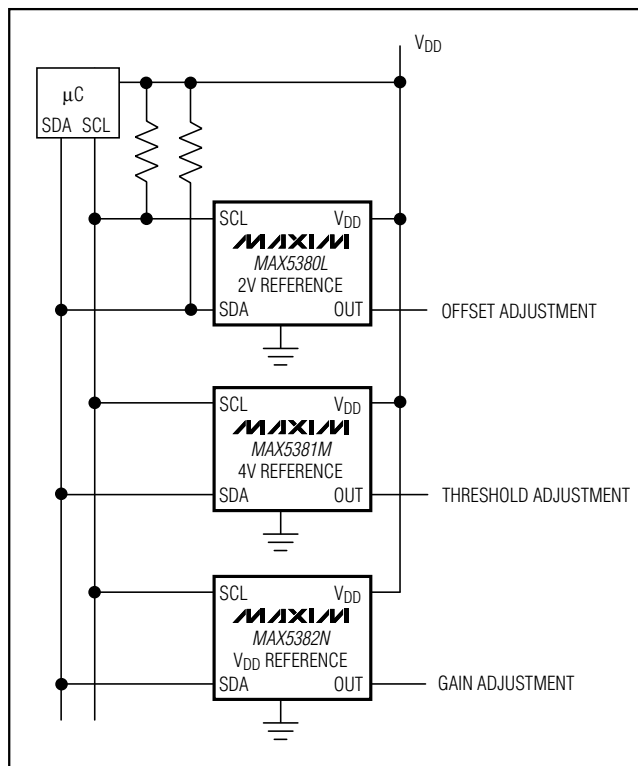

Figure 7. Typical I<sup>2</sup>C Application

are supported. RESTART protocol is supported, but an immediate STOP condition is necessary to update the DAC. The 8th bit of the address byte, typically used to indicate a read or write protocol, is used in the MAX5380/MAX5381/MAX5382 to enter or exit shutdown mode. When MAX5380/MAX5381/MAX5382 are addressed in I<sup>2</sup>C read mode, they enter shutdown mode.

## Applications Information

### Digital Inputs and Interface Logic

The serial 2-wire interface has logic levels defined as  $V_{IL} = 0.3 \times V_{DD}$  and  $V_{IH} = 0.7 \times V_{DD}$ . All inputs include Schmitt trigger buffers to accept slow-transition interfaces. This means that optocouplers can interface directly to the MAX5380/MAX5381/MAX5382 without additional external logic. The digital inputs are compatible with CMOS logic levels and must not be driven with voltages higher than  $V_{DD}$ .

### Power-Supply Bypassing and Layout

Careful printed circuit board layout is important for best system performance. To reduce crosstalk and noise injection, keep analog and digital signals separate. Ensure that the ground return from GND to the supply ground is short and low impedance; a ground plane is recommended. Bypass  $V_{DD}$  with a 0.1µF capacitor to ground as close as possible to the device. If the supply is excessively noisy, connect a 10Ω resistor in series with the supply and  $V_{DD}$  and add additional capacitance.

## Chip Information

TRANSISTOR COUNT: 2910

# Low-Cost, Low-Power, 8-Bit DACs with 2-Wire Serial Interface in SOT23

## Package Information

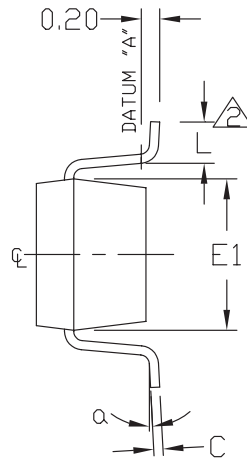
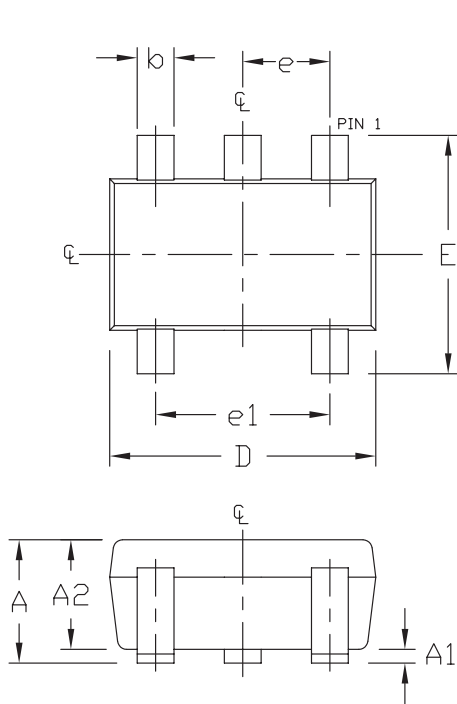

SYMBOL	MIN	MAX
A	0.90	1.45
A1	0.00	0.15
A2	0.90	1.30
b	0.35	0.50
C	0.08	0.20
D	2.80	3.00
E	2.60	3.00
E1	1.50	1.75
L	0.35	0.55
e	0.95	REF
e1	1.90	REF
alpha	0°	10°

SOT23LEP

- NOTES:
1. ALL DIMENSIONS ARE IN MILLIMETERS.
  2. FOOT LENGTH MEASURED AT INTERCEPT POINT BETWEEN DATUM A & LEAD SURFACE.
  3. PACKAGE OUTLINE EXCLUSIVE OF MOLD FLASH & METAL BURR.
  4. PACKAGE OUTLINE INCLUSIVE OF SOLDER PLATING.
  5. MEETS JEDEC MO178.

<b>MAXIM</b>			
<small>PROPRIETARY INFORMATION</small>			
<small>TITLE:</small>			
PACKAGE OUTLINE, SOT-23, 5L			
<small>APPROVAL</small>	<small>DOCUMENT CONTROL NO.</small>	<small>REV</small>	<small>1/1</small>
	21-0057	C	

Maxim cannot assume responsibility for use of any circuitry other than circuitry entirely embodied in a Maxim product. No circuit patent licenses are implied. Maxim reserves the right to change the circuitry and specifications without notice at any time.

12 **Maxim Integrated Products, 120 San Gabriel Drive, Sunnyvale, CA 94086 408-737-7600**