



# 1Mbps, 1µA RS-232 Transmitters in SOT23-6

## General Description

The MAX3188/MAX3189 single RS-232 transmitters in a SOT23-6 package are for space- and cost-constrained applications requiring minimal RS-232 communications. These devices consume only 150µA of supply current from ±4.5V to ±6V supplies. RS-232 data transmission is guaranteed up to 250kbps with the MAX3188 and up to 1Mbps with the MAX3189.

The MAX3188/MAX3189 transmitters are inverting level translators that convert CMOS-logic levels to 5V EIA/TIA-232 levels. They feature a shutdown input that reduces current consumption to only 1µA and forces the transmitter output into a high-impedance state. The MAX3188/MAX3189 transmitters have a standard inverting output.

## Applications

- Diagnostic Ports
- Telecommunications
- Networking Equipment
- Set-Top Boxes
- Digital Cameras
- Hand-Held Equipment

## Typical Operating Circuit

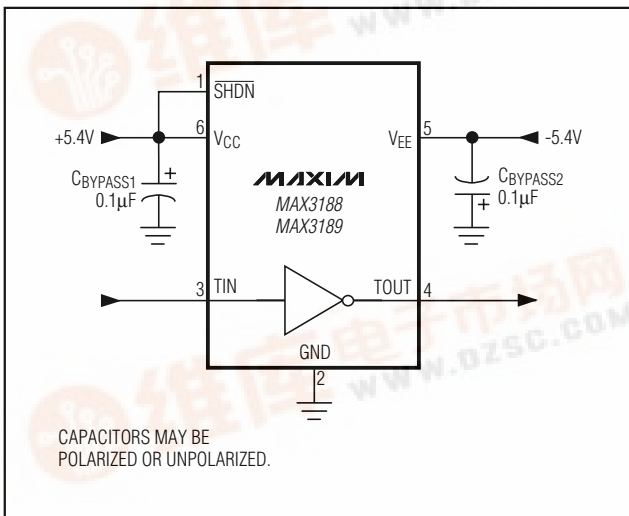

## Features

- ◆ Small 6-Pin SOT23 Package
- ◆ 150µA Supply Current
- ◆ Shutdown Reduces Supply Current to 1µA
- ◆ Guaranteed Data Rate
  - 1Mbps (MAX3189)
  - 250kbps (MAX3188)
- ◆ Three-State RS-232 Transmitter Output
- ◆ No External Components Required

## Ordering Information

PART	TEMP. RANGE	PIN-PACKAGE	TOP MARK
MAX3188EUT-T	-40°C to +85°C	6 SOT23-6	AAHJ
MAX3189EUT-T	-40°C to +85°C	6 SOT23-6	AAHK

## Pin Configuration

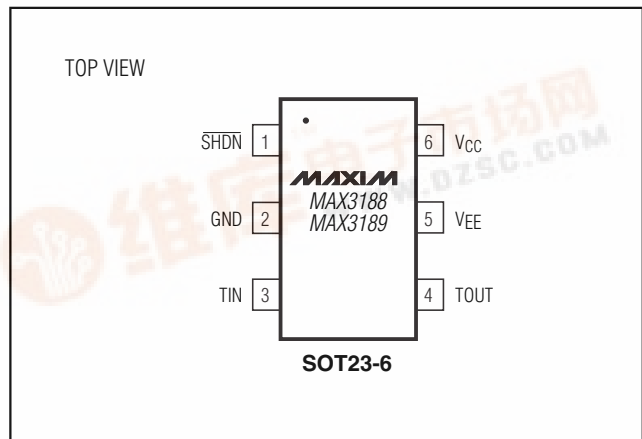

MAX3188/MAX3189

# 1Mbps, 1μA RS-232 Transmitters in SOT23-6

## ABSOLUTE MAXIMUM RATINGS

V <sub>CC</sub> to GND (Note 1)	-0.3V to +7V	Continuous Power Dissipation (T <sub>A</sub> = +70°C)	
V <sub>EE</sub> to GND (Note 1)	+0.3V to -7V	6-Pin SOT23 (derate 8.7mW/°C above +70°C)	691mW
V <sub>CC</sub> to V <sub>EE</sub> (Note 1)	+13V	Operating Temperature Range	-40°C to +85°C
TIN, SHDN to GND	-0.3V to +7V	Junction Temperature	+150°C
TOUT to GND (SHDN = GND)	±13.2V	Storage Temperature Range	-65°C to +160°C
TOUT to GND (SHDN = V <sub>CC</sub> )	±7V	Lead Temperature (soldering, 10s)	+300°C
Output Short-Circuit Duration	Continuous		

**Note 1:** V<sub>CC</sub> and V<sub>EE</sub> can have maximum magnitudes of 7V, but their absolute difference cannot exceed 13V.

Stresses beyond those listed under "Absolute Maximum Ratings" may cause permanent damage to the device. These are stress ratings only, and functional operation of the device at these or any other conditions beyond those indicated in the operational sections of the specifications is not implied. Exposure to absolute maximum rating conditions for extended periods may affect device reliability.

## ELECTRICAL CHARACTERISTICS

(V<sub>CC</sub> = +4.5V to +6V, V<sub>EE</sub> = -4.5V to -6V, T<sub>A</sub> = T<sub>MIN</sub> to T<sub>MAX</sub>, unless otherwise noted. Typical values are at V<sub>CC</sub> = +5.4V, V<sub>EE</sub> = -5.4V, and T<sub>A</sub> = +25°C.) (Note 2)

PARAMETER	SYMBOL	CONDITIONS	MIN	TYP	MAX	UNITS
<b>DC CHARACTERISTICS</b>						
Positive Supply Voltage	V <sub>CC</sub>		4.5		6	V
Negative Supply Voltage	V <sub>EE</sub>		-6		-4.5	V
Positive Supply Current	I <sub>CC</sub>	V <sub>SHDN</sub> = 5V		110	170	μA
Negative Supply Current	I <sub>EE</sub>	V <sub>SHDN</sub> = 5V	45	34		μA
Shutdown Supply Current		V <sub>SHDN</sub> = 0		0.2	1	μA
<b>INPUT LOGIC (TIN, SHDN)</b>						
Input Logic Threshold Low	V <sub>IL</sub>				0.8	V
Input Logic Threshold High	V <sub>IH</sub>		2.0			V
Input Leakage				±0.01	±1	μA
TIN Input Hysteresis				100		mV
<b>TRANSMITTER OUTPUTS</b>						
Output Voltage Swing	V <sub>TOUT</sub>	V <sub>CC</sub> = 4.5V, V <sub>EE</sub> = -4.5V, R <sub>L</sub> = 3kΩ	±3.7			V
		V <sub>CC</sub> = 5.4V, V <sub>EE</sub> = -5.4V, R <sub>L</sub> = 3kΩ	±5			
Output Resistance	R <sub>TOUT</sub>	V <sub>CC</sub> = V <sub>EE</sub> = 0, V <sub>TOUT</sub> = ±2V	300			Ω
Output Short-Circuit Current				±35	±60	mA
Output Leakage Current	I <sub>TOUT</sub>	V <sub>OUT</sub> = ±12V; V <sub>CC</sub> = V <sub>EE</sub> = 0 or V <sub>CC</sub> = +5.4V, V <sub>EE</sub> = -5.4V; SHDN = 0			±25	μA
<b>TIMING CHARACTERISTICS</b>						
Maximum Data Rate		R <sub>L</sub> = 3kΩ, C <sub>L</sub> = 1000pF	MAX3188EUT	0.25		Mbps
			MAX3189EUT	1		
Transmitter Skew	t <sub>TS</sub>	t <sub>PHL</sub> - t <sub>PLH</sub>  , Figure 1	MAX3188EUT	100		ns
			MAX3189EUT	25		
Transition-Region Slew Rate		R <sub>L</sub> = 3kΩ to 7kΩ, C <sub>L</sub> = 150pF to 1000pF, measured from -3V to +3V or +3V to -3V, V <sub>CC</sub> = 5.4V, V <sub>EE</sub> = -5.4V, T <sub>A</sub> = +25°C	MAX3188EUT	6	30	V/μs
			MAX3189EUT	24	150	
Transmitter Enable Time	t <sub>EN</sub>			2		μs

**Note 2:** All devices are 100% tested at T<sub>A</sub> = +25°C. All limits over temperature are guaranteed by design.

# 1Mbps, 1μA RS-232 Transmitters in SOT23-6

## Typical Operating Characteristics

( $V_{CC} = +5.4V$ ,  $V_{EE} = -5.4V$ ,  $R_L = 3k\Omega$ ,  $T_A = +25^\circ C$ , unless otherwise noted.)

**MAX3188/MAX3189**

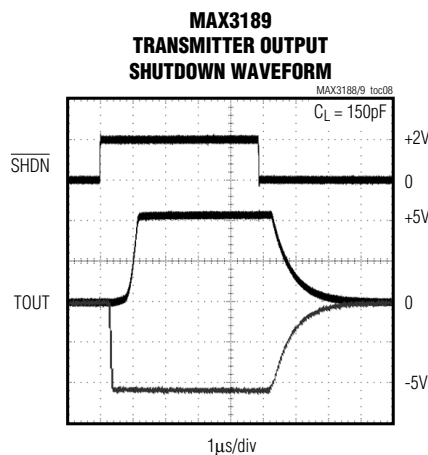
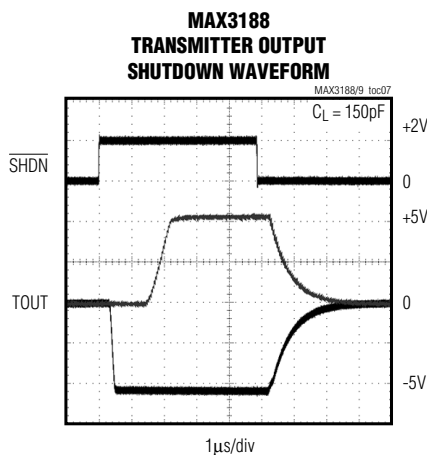
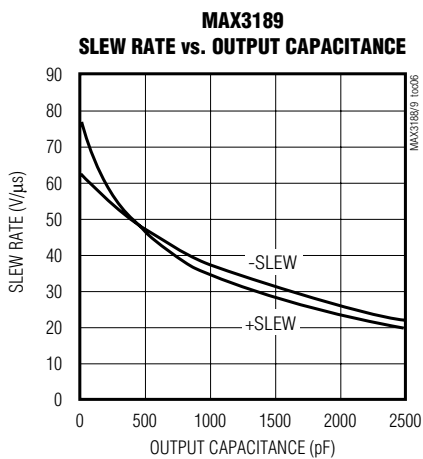
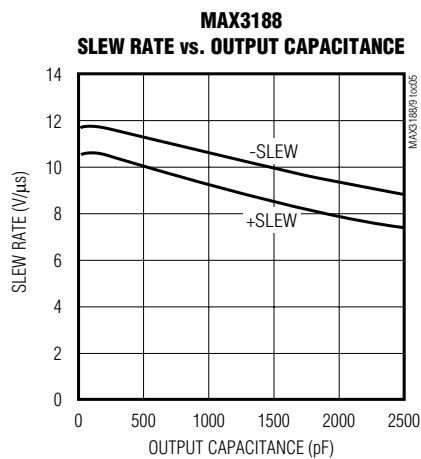
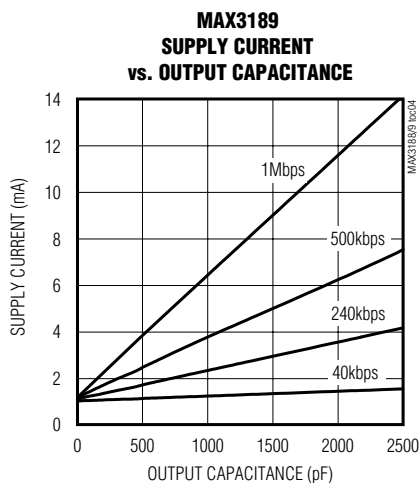
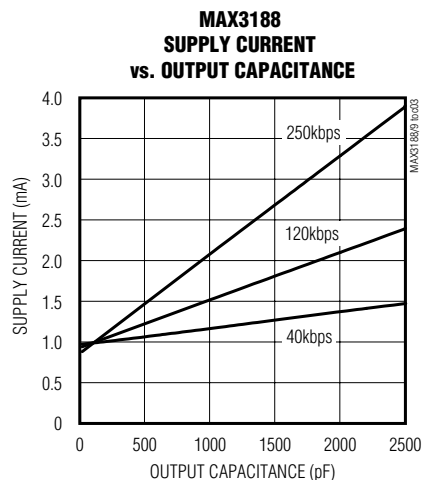
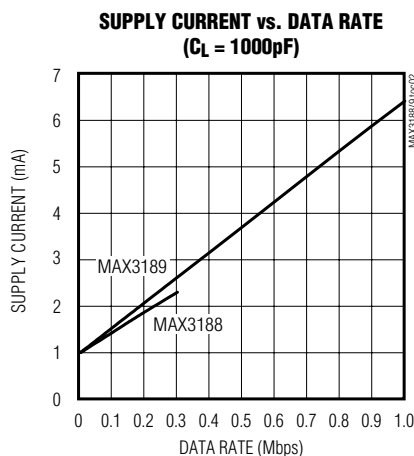
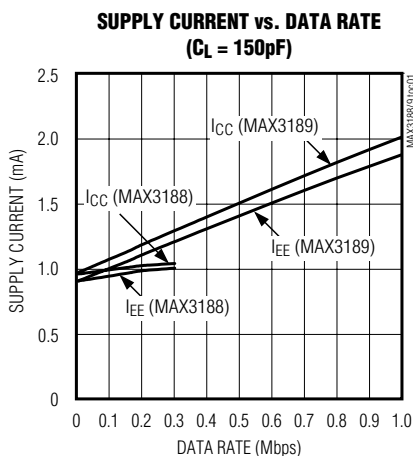

# 1Mbps, 1 $\mu$ A RS-232 Transmitters in SOT23-6

## Pin Description

PIN	NAME	FUNCTION
1	$\overline{\text{SHDN}}$	Active-Low Shutdown. Pull low to reduce the supply current and to force TOUT into a high-impedance state.
2	GND	Ground
3	TIN	TTL/CMOS Transmitter Input
4	TOUT	RS-232 Transmitter Output
5	VEE	Negative Supply Voltage
6	VCC	Positive Supply Voltage

## Detailed Description

The transmitter is an inverting level translator that converts CMOS-logic levels to 5V EIA/TIA-232 levels. The MAX3188 guarantees a 250kbps data rate, and the MAX3189 guarantees a 1Mbps data rate with worst-case loads of 3k $\Omega$  in parallel with 1000pF. The transmitter input does not have a pull-up resistor and should be connected to GND if unused.

### Shutdown

The MAX3188/MAX3189 feature a shutdown input. Drive  $\overline{\text{SHDN}}$  low to reduce the supply current to 1 $\mu$ A (max). Shutdown also forces TOUT into a high-impedance state that allows the signal line to be safely controlled by other transmitters. Drive  $\overline{\text{SHDN}}$  high for normal operation.

### Power-Supply Decoupling

In most circumstances, 0.1 $\mu$ F bypass capacitors are adequate for power-supply decoupling. Connect the bypass capacitors as close to the IC as possible.

## Applications Information

### Power-Supply Sources

The MAX3188/MAX3189 require  $\pm 4.5\text{V}$  to  $\pm 6\text{V}$  dual supplies. For applications where these supply voltages are not present, a DC-DC converter must be added. Due to the devices' low current consumption, a charge pump can provide the proper supply voltages and requires a minimal amount of board space and cost.

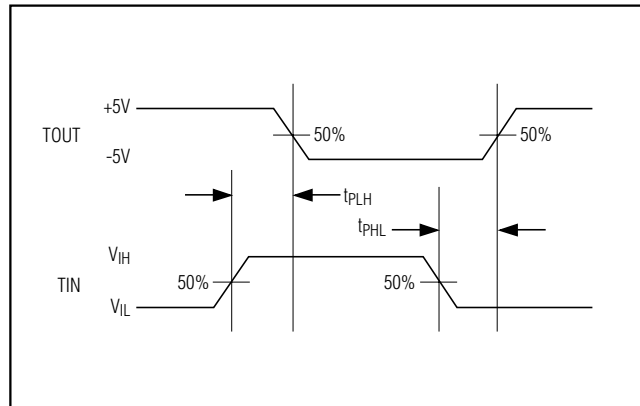

Figure 1. Transmitter Propagation-Delay Timing

When using another RS-232 device containing an internal regulated charge pump (Table 1), the MAX3188/MAX3189 may be powered from the internal charge pump (Figure 2). This eliminates the need for additional external DC-DC converters to generate the required  $\pm 4.5\text{V}$  to  $\pm 6\text{V}$  dual supplies.

# 1Mbps, 1 $\mu$ A RS-232 Transmitters in SOT23-6

**Table 1. RS-232 Devices with Internal Regulated Charge Pumps**

PART	NO. OF Tx/Rx	$\pm$ 15kV ESD PROTECTION	AutoShutdown Plus™	AutoShutdown™	DATA RATE (bps)
MAX3221	1/1			✓	120k
MAX3221E	1/1	✓		✓	250k
MAX3222	2/2				120k
MAX3222E	2/2	✓			250k
MAX3223	2/2			✓	120k
MAX3223E	2/2	✓		✓	250k
MAX3224	2/2		✓		250k
MAX3224E	2/2	✓	✓		250k
MAX3225	2/2		✓		1M
MAX3225E	2/2	✓	✓		1M
MAX3226	1/1		✓		250k
MAX3226E	1/1	✓	✓		250k
MAX3227	1/1		✓		1M
MAX3227E	1/1	✓	✓		1M
MAX3232	2/2				120k
MAX3232E	2/2	✓			250k
MAX3237	5/3				1M
MAX3238	5/3		✓		250k
MAX3241	3/5				120k
MAX3241E	3/5	✓			250k
MAX3243	3/5			✓	120k
MAX3243E	3/5	✓		✓	250k
MAX3244	3/5		✓		250k
MAX3244E	3/5	✓	✓		250k
MAX3245	3/5		✓		1M
MAX3245E	3/5	✓	✓		1M

**MAX3188/MAX3189**

*AutoShutdown and AutoShutdown Plus are trademarks of Maxim Integrated Products.*

# 1Mbps, 1µA RS-232 Transmitters in SOT23-6

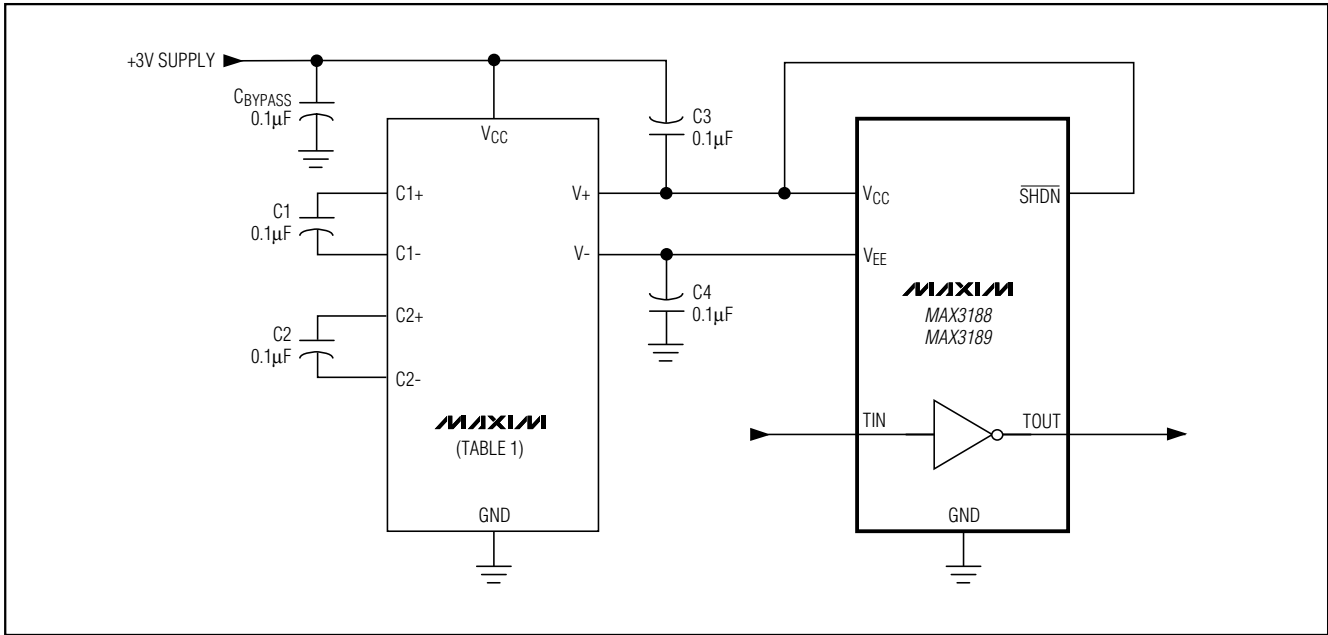

Figure 2. Powering the MAX3188/MAX3189

**Chip Information**  
TRANSISTOR COUNT: 111

# 1Mbps, 1µA RS-232 Transmitters in SOT23-6

## Package Information

MAX3188/MAX3189

6LSOT.EPS

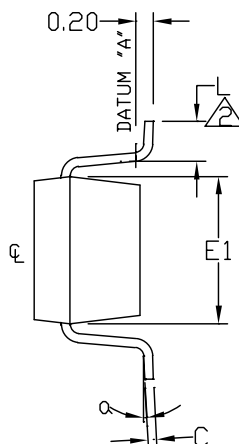
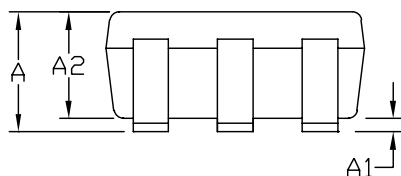
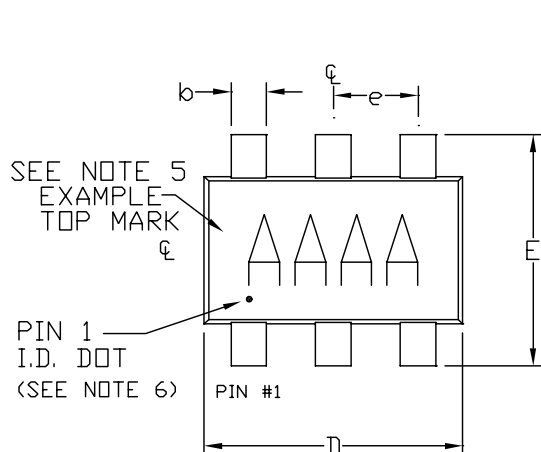

SYMBOL	MIN	MAX
A	0.90	1.45
A1	0.00	0.15
A2	0.90	1.30
b	0.35	0.50
C	0.08	0.20
D	2.80	3.00
E	2.60	3.00
E1	1.50	1.75
L	0.35	0.55
e	0.95 REF	
α	0°	10°

**NOTE:**

1. ALL DIMENSIONS ARE IN MILLIMETERS.
2. FOOT LENGTH MEASURED AT INTERCEPT POINT BETWEEN DATUM A & LEAD SURFACE.
3. PACKAGE OUTLINE EXCLUSIVE OF MOLD FLASH & METAL BURR.
4. PACKAGE OUTLINE INCLUSIVE OF SOLDER PLATING.
5. PIN 1 IS LOWER LEFT PIN WHEN READING TOP MARK FROM LEFT TO RIGHT. (SEE EXAMPLE TOP MARK)
6. PIN 1 I.D. DOT IS 0.3 MM Ø MIN. LOCATED ABOVE PIN 1.

<b>MAXIM</b>			
<small>PROPRIETARY INFORMATION</small>			
<small>TITLE:</small>			
PACKAGE OUTLINE, SOT23, 6L			
<small>APPROVAL</small>	<small>DOCUMENT CONTROL NO.</small>	<small>REV</small>	<small>1/1</small>
	21-0058	D	

# **1Mbps, 1 $\mu$ A RS-232 Transmitters in SOT23-6**

## **NOTES**

*Maxim cannot assume responsibility for use of any circuitry other than circuitry entirely embodied in a Maxim product. No circuit patent licenses are implied. Maxim reserves the right to change the circuitry and specifications without notice at any time.*

**8** \_\_\_\_\_ **Maxim Integrated Products, 120 San Gabriel Drive, Sunnyvale, CA 94086 408-737-7600**