

# The RF MOSFET Line

## RF Power Field Effect Transistors

### N-Channel Enhancement-Mode Lateral MOSFETs

**MRF21045LR3**  
**MRF21045LSR3**

Designed for W-CDMA base station applications with frequencies from 2110 to 2170 MHz. Suitable for TDMA, CDMA and multicarrier amplifier applications. To be used in Class AB for PCN - PCS/cellular radio and WLL applications.

- Typical 2-carrier W-CDMA Performance for  $V_{DD} = 28$  Volts,  $I_{DQ} = 500$  mA,  $f_1 = 2135$  MHz,  $f_2 = 2145$  MHz, Channel Bandwidth = 3.84 MHz, Adjacent Channels measured over 3.84 MHz Bandwidth at  $f_1 - 5$  MHz and  $f_2 + 5$  MHz, Distortion Products measured over a 3.84 MHz Bandwidth at  $f_1 - 10$  MHz and  $f_2 + 10$  MHz, Peak/Avg. = 8.3 dB @ 0.01% Probability on CCDF.
  - Output Power — 10 Watts Avg.
  - Efficiency — 23.5%
  - Gain — 15 dB
  - IM3 — -37.5 dBc
  - ACPR — -41 dBc
- Internally Matched, Controlled Q, for Ease of Use
- High Gain, High Efficiency and High Linearity
- Integrated ESD Protection
- Designed for Maximum Gain and Insertion Phase Flatness
- Capable of Handling 5:1 VSWR, @ 28 Vdc, 2170 MHz, 45 Watts CW Output Power
- Excellent Thermal Stability
- Characterized with Series Equivalent Large-Signal Impedance Parameters
- Low Gold Plating Thickness on Leads, 40 $\mu$ m Nominal.
- In Tape and Reel. R3 Suffix = 250 Units per 32 mm, 13 Inch Reel.

**2170 MHz, 45 W, 28 V**  
**LATERAL N-CHANNEL**  
**RF POWER MOSFETs**

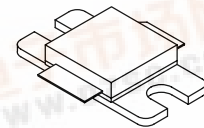

**CASE 465E-04, STYLE 1**  
**NI-400**  
**MRF21045LR3**

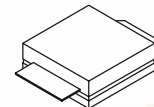

**CASE 465F-04, STYLE 1**  
**NI-400S**  
**MRF21045LSR3**

#### MAXIMUM RATINGS

Rating	Symbol	Value	Unit
Drain-Source Voltage	$V_{DSS}$	65	Vdc
Gate-Source Voltage	$V_{GS}$	-0.5, +15	Vdc
Total Device Dissipation @ $T_C = 25^\circ\text{C}$ Derate above 25 $^\circ\text{C}$	$P_D$	105 0.60	Watts W/ $^\circ\text{C}$
Storage Temperature Range	$T_{stg}$	- 65 to +150	$^\circ\text{C}$
Operating Junction Temperature	$T_J$	200	$^\circ\text{C}$

#### ESD PROTECTION CHARACTERISTICS

Test Conditions	Class
Human Body Model	1 (Minimum)
Machine Model	M2 (Minimum)

#### THERMAL CHARACTERISTICS

Characteristic	Symbol	Max	Unit
Thermal Resistance, Junction to Case	$R_{\theta JC}$	1.65	$^\circ\text{C}/\text{W}$

NOTE - **CAUTION** - MOS devices are susceptible to damage from electrostatic charge. Reasonable precautions in handling and packaging MOS devices should be observed.

# Freescale Semiconductor, Inc.

## ELECTRICAL CHARACTERISTICS (T<sub>C</sub> = 25°C unless otherwise noted)

Characteristic	Symbol	Min	Typ	Max	Unit
<b>OFF CHARACTERISTICS</b>					
Drain-Source Breakdown Voltage (V <sub>GS</sub> = 0 Vdc, I <sub>D</sub> = 100 μAdc)	V <sub>(BR)DSS</sub>	65	—	—	Vdc
Zero Gate Voltage Drain Current (V <sub>DS</sub> = 28 Vdc, V <sub>GS</sub> = 0 Vdc)	I <sub>DSS</sub>	—	—	10	μAdc
Gate-Source Leakage Current (V <sub>GS</sub> = 5 Vdc, V <sub>DS</sub> = 0 Vdc)	I <sub>GSS</sub>	—	—	1	μAdc
<b>ON CHARACTERISTICS (DC)</b>					
Gate Threshold Voltage (V <sub>DS</sub> = 10 Vdc, I <sub>D</sub> = 100 μAdc)	V <sub>GS(th)</sub>	2	—	4	Vdc
Gate Quiescent Voltage (V <sub>DS</sub> = 28 Vdc, I <sub>D</sub> = 500 mAdc)	V <sub>GS(Q)</sub>	3	3.9	5	Vdc
Drain-Source On-Voltage (V <sub>GS</sub> = 10 Vdc, I <sub>D</sub> = 1 Adc)	V <sub>DS(on)</sub>	—	0.19	0.21	Vdc
Forward Transconductance (V <sub>DS</sub> = 10 Vdc, I <sub>D</sub> = 1 Adc)	g <sub>fs</sub>	—	3	—	S
<b>DYNAMIC CHARACTERISTICS (1)</b>					
Reverse Transfer Capacitance (V <sub>DS</sub> = 28 Vdc, V <sub>GS</sub> = 0, f = 1 MHz)	C <sub>rss</sub>	—	1.8	—	pF
<b>FUNCTIONAL TESTS</b> (In Motorola Test Fixture, 50 ohm system) 2-carrier W-CDMA. Peak/Avg. ratio = 8.3 dB @ 0.01% Probability on CCDF.					
Common-Source Amplifier Power Gain (V <sub>DD</sub> = 28 Vdc, P <sub>out</sub> = 10 W Avg., I <sub>DQ</sub> = 500 mA, f <sub>1</sub> = 2112.5 MHz, f <sub>2</sub> = 2122.5 MHz and f <sub>1</sub> = 2157.5 MHz, f <sub>2</sub> = 2167.5 MHz)	G <sub>ps</sub>	13.5	15	—	dB
Drain Efficiency (V <sub>DD</sub> = 28 Vdc, P <sub>out</sub> = 10 W Avg., I <sub>DQ</sub> = 500 mA, f <sub>1</sub> = 2112.5 MHz, f <sub>2</sub> = 2122.5 MHz and f <sub>1</sub> = 2157.5 MHz, f <sub>2</sub> = 2167.5 MHz)	η	21	23.5	—	%
Third Order Intermodulation Distortion (V <sub>DD</sub> = 28 Vdc, P <sub>out</sub> = 10 W Avg., I <sub>DQ</sub> = 500 mA, f <sub>1</sub> = 2112.5 MHz, f <sub>2</sub> = 2122.5 MHz and f <sub>1</sub> = 2157.5 MHz, f <sub>2</sub> = 2167.5 MHz; IM3 measured over 3.84 MHz Bandwidth at f <sub>1</sub> -10 MHz and f <sub>2</sub> +10 MHz.)	IM3	—	-37.5	-35	dBc
Adjacent Channel Power Ratio (V <sub>DD</sub> = 28 Vdc, P <sub>out</sub> = 10 W Avg., I <sub>DQ</sub> = 500 mA, f <sub>1</sub> = 2112.5 MHz, f <sub>2</sub> = 2122.5 MHz and f <sub>1</sub> = 2157.5 MHz, f <sub>2</sub> = 2167.5 MHz; ACPR measured over 3.84 MHz Bandwidth at f <sub>1</sub> -5 MHz and f <sub>2</sub> +5 MHz.)	ACPR	—	-41	-38	dBc
Input Return Loss (V <sub>DD</sub> = 28 Vdc, P <sub>out</sub> = 10 W Avg., I <sub>DQ</sub> = 500 mA, f <sub>1</sub> = 2112.5 MHz, f <sub>2</sub> = 2122.5 MHz and f <sub>1</sub> = 2157.5 MHz, f <sub>2</sub> = 2167.5 MHz)	IRL	—	-12	-9	dB
Output Mismatch Stress (V <sub>DD</sub> = 28 Vdc, P <sub>out</sub> = 45 W CW, I <sub>DQ</sub> = 500 mA, f = 2170 MHz VSWR = 5:1, All Phase Angles at Frequency of Tests)	Ψ	No Degradation In Output Power Before and After Test			

(1) Part is internally matched both on input and output.

# Freescale Semiconductor, Inc.

## ELECTRICAL CHARACTERISTICS — continued ( $T_C = 25^\circ\text{C}$ unless otherwise noted)

Characteristic	Symbol	Min	Typ	Max	Unit
<b>FUNCTIONAL TESTS</b> (In Motorola Test Fixture, 50 ohm system) — continued					
Two-Tone Common-Source Amplifier Power Gain ( $V_{DD} = 28\text{ Vdc}$ , $P_{out} = 45\text{ W PEP}$ , $I_{DQ} = 500\text{ mA}$ , $f_1 = 2110\text{ MHz}$ , $f_2 = 2120\text{ MHz}$ and $f_1 = 2160\text{ MHz}$ , $f_2 = 2170\text{ MHz}$ )	$G_{ps}$	—	14.9	—	dB
Two-Tone Drain Efficiency ( $V_{DD} = 28\text{ Vdc}$ , $P_{out} = 45\text{ W PEP}$ , $I_{DQ} = 500\text{ mA}$ , $f_1 = 2110\text{ MHz}$ , $f_2 = 2120\text{ MHz}$ and $f_1 = 2160\text{ MHz}$ , $f_2 = 2170\text{ MHz}$ )	$\eta$	—	36	—	%
Intermodulation Distortion ( $V_{DD} = 28\text{ Vdc}$ , $P_{out} = 45\text{ W PEP}$ , $I_{DQ} = 500\text{ mA}$ , $f_1 = 2110\text{ MHz}$ , $f_2 = 2120\text{ MHz}$ and $f_1 = 2160\text{ MHz}$ , $f_2 = 2170\text{ MHz}$ )	IMD	—	-30	—	dBc
Two-Tone Input Return Loss ( $V_{DD} = 28\text{ Vdc}$ , $P_{out} = 45\text{ W PEP}$ , $I_{DQ} = 500\text{ mA}$ , $f_1 = 2110\text{ MHz}$ , $f_2 = 2120\text{ MHz}$ and $f_1 = 2160\text{ MHz}$ , $f_2 = 2170\text{ MHz}$ )	IRL	—	-12	—	dB
$P_{out, 1\text{ dB Compression Point}}$ ( $V_{DD} = 28\text{ Vdc}$ , $I_{DQ} = 500\text{ mA}$ , $f = 2170\text{ MHz}$ )	$P_{1dB}$	—	50	—	W

## Freescale Semiconductor, Inc.

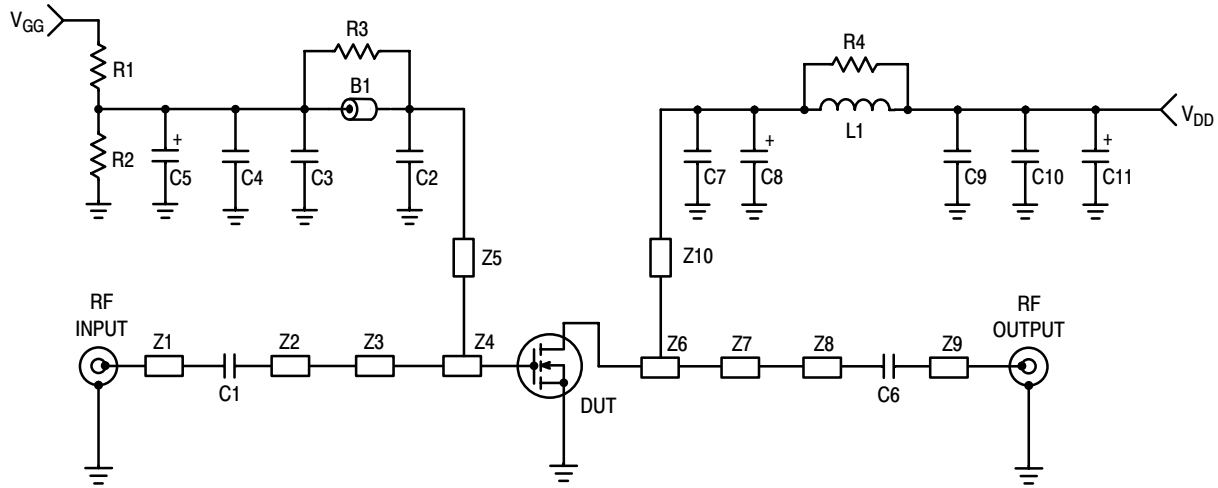

Z1, Z9	0.750" x 0.084" Transmission Line	Board	0.030" Glass Teflon <sup>®</sup> ,
Z2	0.160" x 0.084" Transmission Line	PCB	Keene GX-0300-55-22, $\epsilon_r = 2.55$
Z3	1.195" x 0.176" Transmission Line		Etched Circuit Boards
Z4	0.125" x 0.320" Transmission Line		MRF21045 Rev. 3, CMR
Z5	1.100" x 0.045" Transmission Line		
Z6	0.442" x 0.650" Transmission Line		
Z7	0.490" x 0.140" Transmission Line		
Z8	0.540" x 0.084" Transmission Line		
Z10	0.825" x 0.055" Transmission Line		

**Figure 1. MRF21045LR3(LSR3) Test Circuit Schematic**

**Table 1. MRF21045LR3(LSR3) Component Designations and Values**

Designators	Description
B1	Short Ferrite Bead, Fair Rite, #2743019447
C1, C2, C6	43 pF Chip Capacitors, ATC #100B430JCA500X
C7	5.6 pF Chip Capacitor, ATC #100B5R6JCA500X
C3, C9	1000 pF Chip Capacitors, ATC #100B102JCA500X
C4, C10	0.1 $\mu$ F Chip Capacitors, Kemet #CDR33BX104AKWS
C5	1.0 $\mu$ F Tantalum Chip Capacitor, Kemet #T491C105M050
C8	10 $\mu$ F Tantalum Chip Capacitor, Kemet #T495X106K035AS4394
C11	22 $\mu$ F Tantalum Chip Capacitor, Kemet #T491X226K035AS4394
L1	1 Turn, #20 AWG, 0.100" ID, Motorola
N1, N2	Type N Flange Mounts, Omni Spectra #3052-1648-10
R1	1.0 k $\Omega$ , 1/8 W Chip Resistor
R2	180 k $\Omega$ , 1/8 W Chip Resistor
R3, R4	10 $\Omega$ , 1/8 W Chip Resistors

# Freescale Semiconductor, Inc.

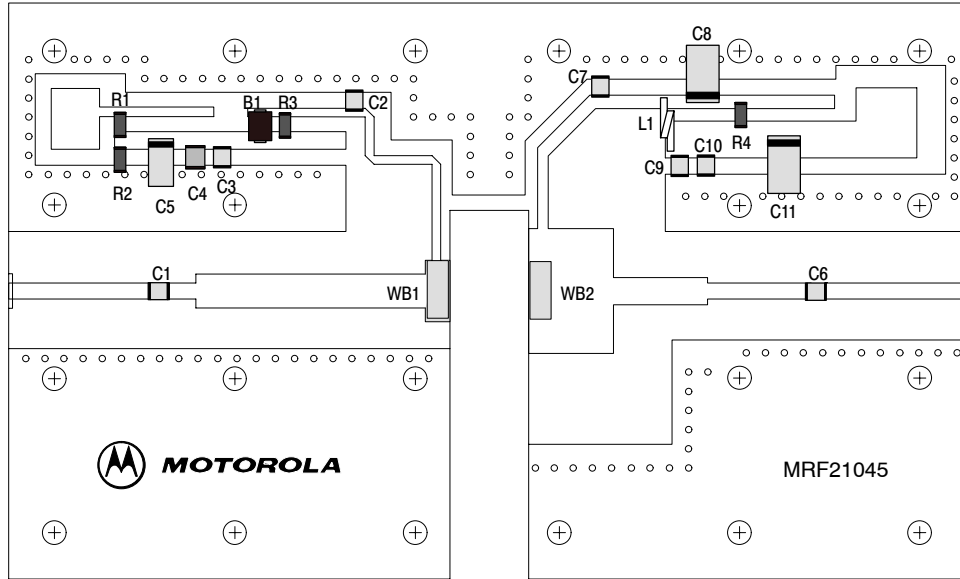
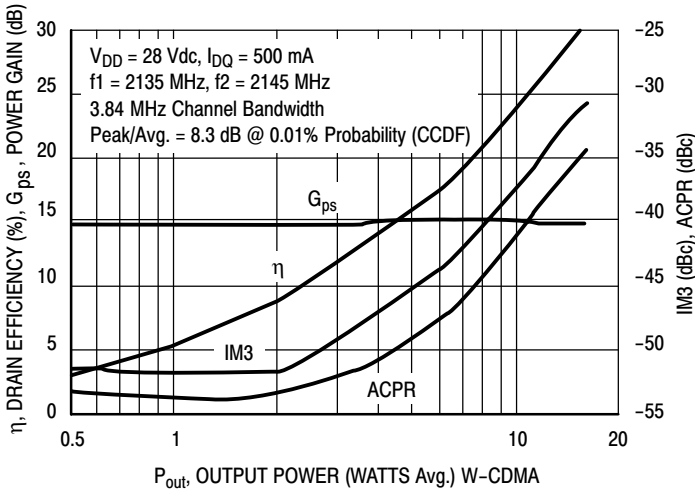

Figure 2. MRF21045LR3(LSR3) Test Circuit Component Layout

# Freescale Semiconductor, Inc.

## TYPICAL CHARACTERISTICS



**Figure 3. 2-Carrier W-CDMA ACPR, IM3, Power Gain and Drain Efficiency versus Output Power**

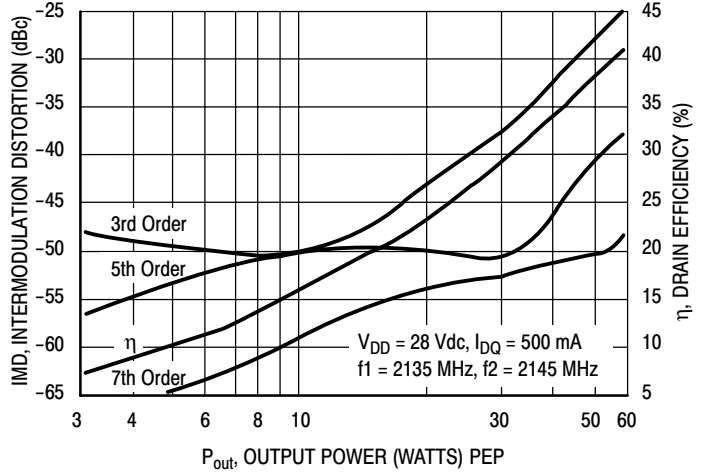

**Figure 4. Intermodulation Distortion Products versus Output Power**

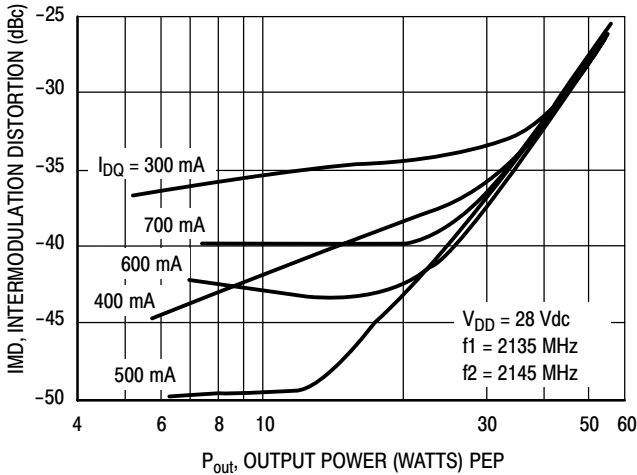

**Figure 5. Intermodulation Distortion versus Output Power**

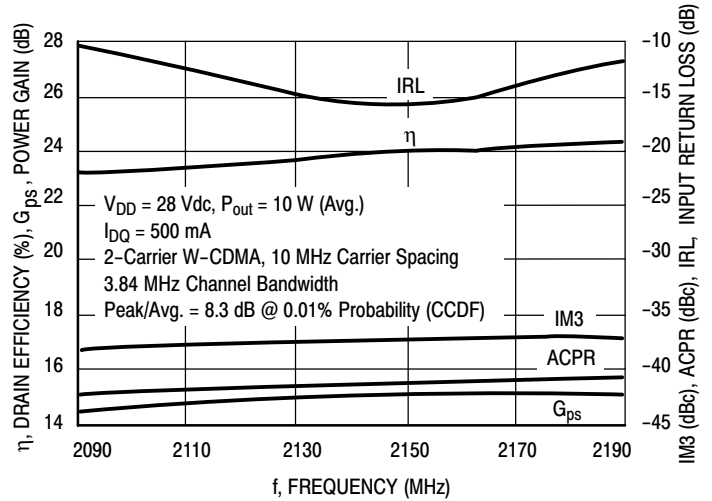

**Figure 6. 2-Carrier W-CDMA Broadband Performance**

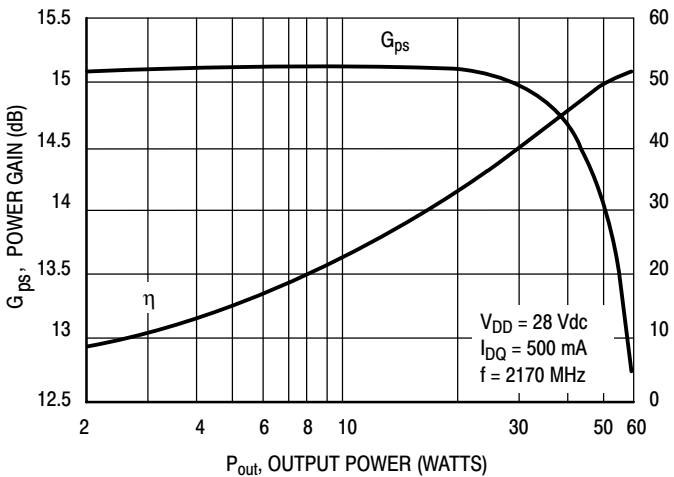

**Figure 7. CW Performance**

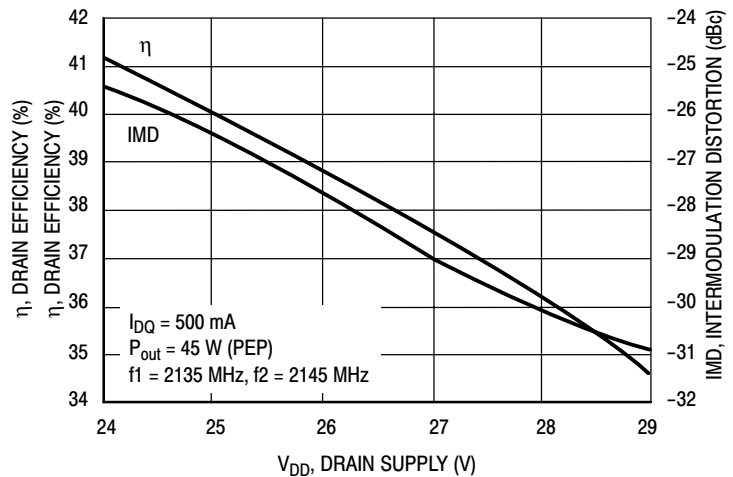
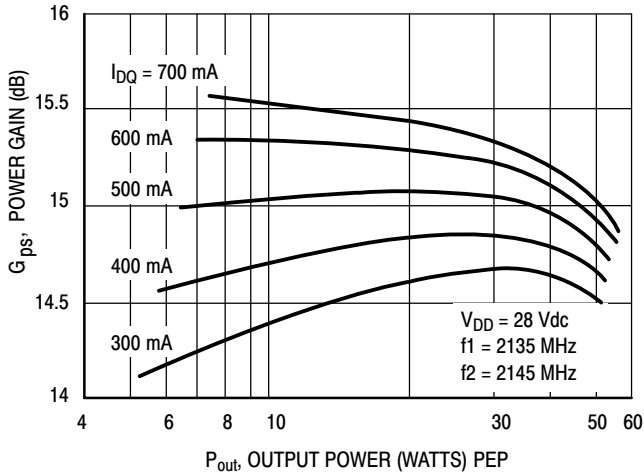

**Figure 8. Two-Tone Intermodulation Distortion and Drain Efficiency versus Drain Supply**

Freescale Semiconductor, Inc.

# Freescale Semiconductor, Inc.

## TYPICAL CHARACTERISTICS



**Figure 9. Two-Tone Power Gain versus Output Power**

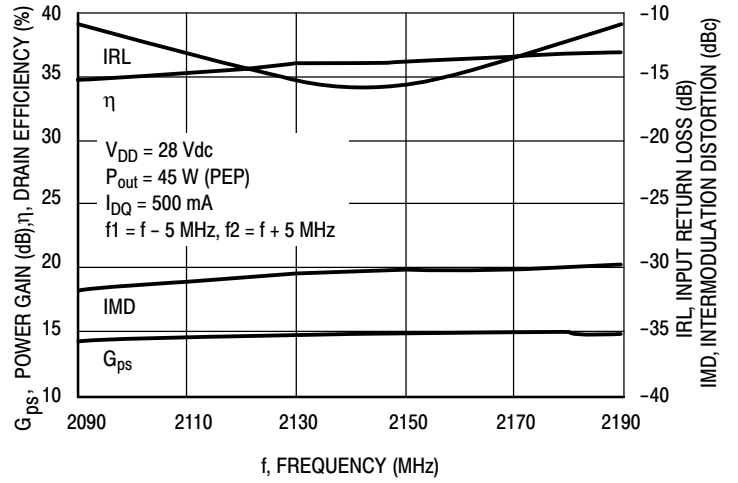

**Figure 10. Two-Tone Broadband Performance**

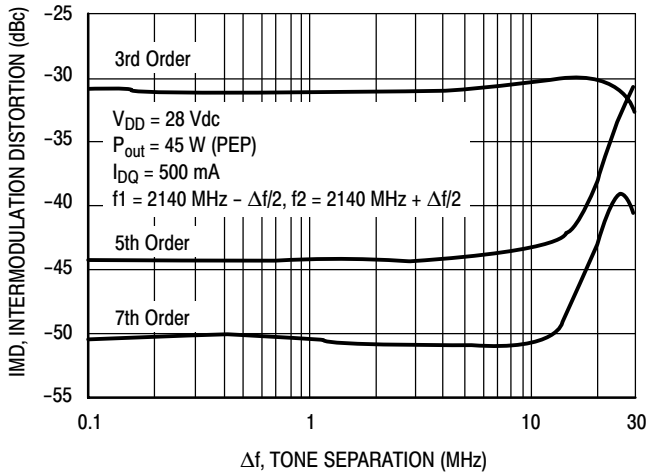

**Figure 11. Intermodulation Distortion Products versus Two-Tone Spacing**

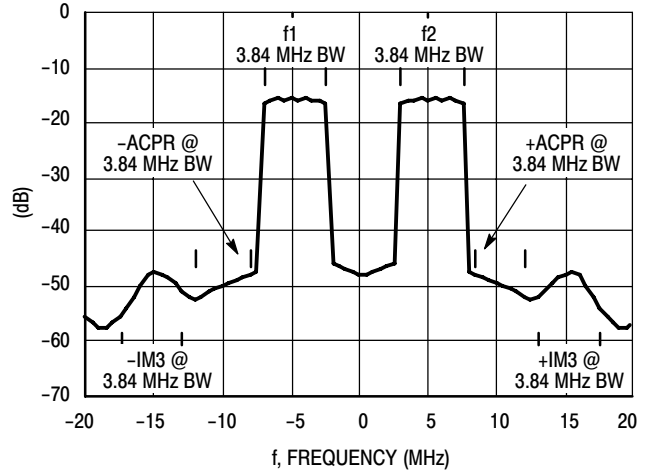

**Figure 12. 2-Carrier W-CDMA Spectrum**

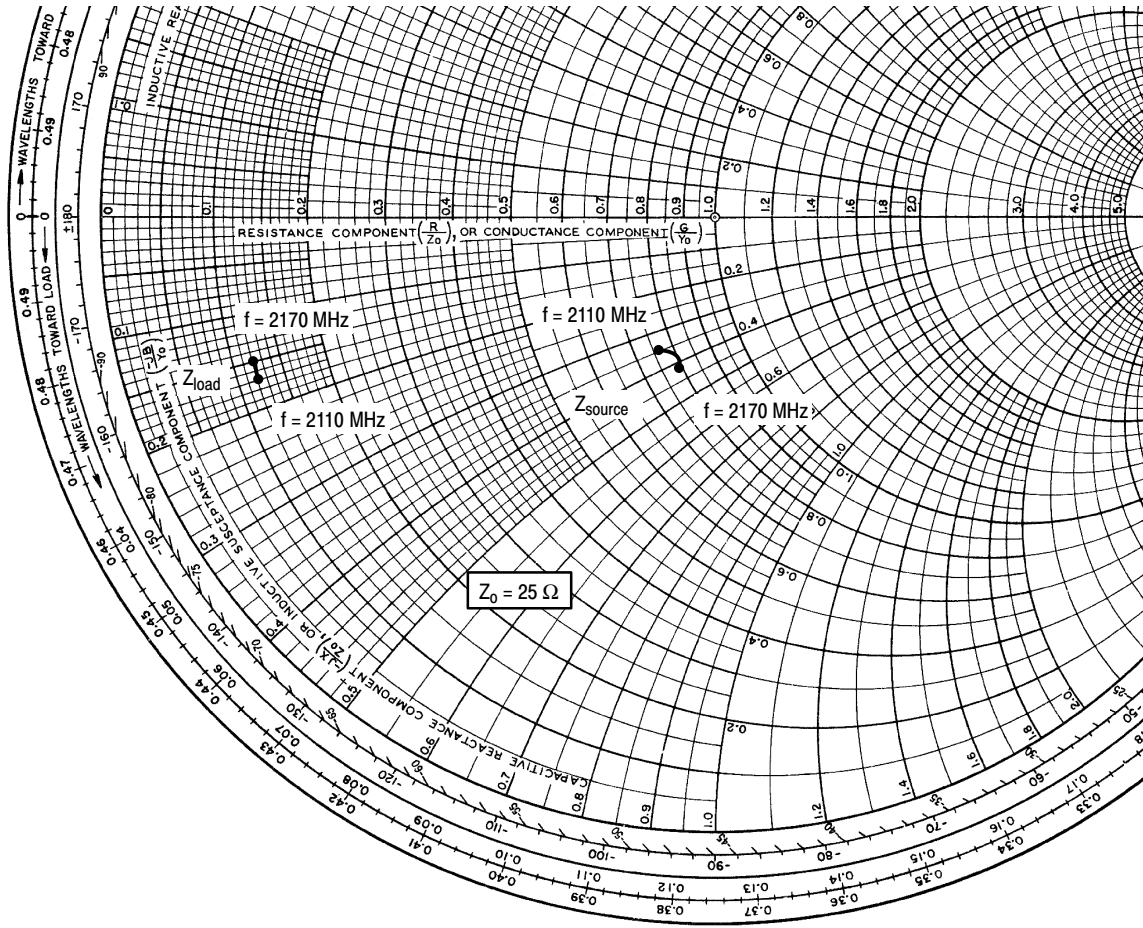

$V_{DD} = 28$  Vdc,  $I_{DQ} = 500$  mA,  $P_{out} = 10$  W Avg.

f MHz	$Z_{source}$ $\Omega$	$Z_{load}$ $\Omega$
2110	18.88 - j8.86	3.11 - j4.18
2140	19.80 - j9.93	3.09 - j3.87
2170	19.68 - j10.44	3.12 - j3.72

$Z_{source}$  = Test circuit impedance as measured from gate to ground.

$Z_{load}$  = Test circuit impedance as measured from drain to ground.

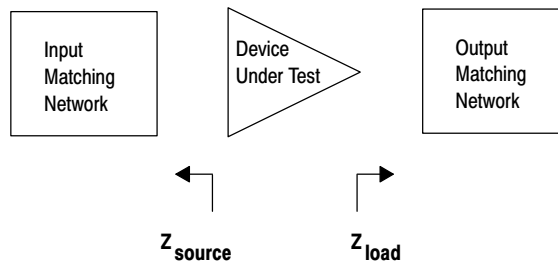

Figure 13. Series Equivalent Source and Load Impedance



**Freescale Semiconductor, Inc.**  
**NOTES**

**Freescale Semiconductor, Inc.**

**Freescale Semiconductor, Inc.**  
**NOTES**

**Freescale Semiconductor, Inc.**

# Freescale Semiconductor, Inc.

## PACKAGE DIMENSIONS

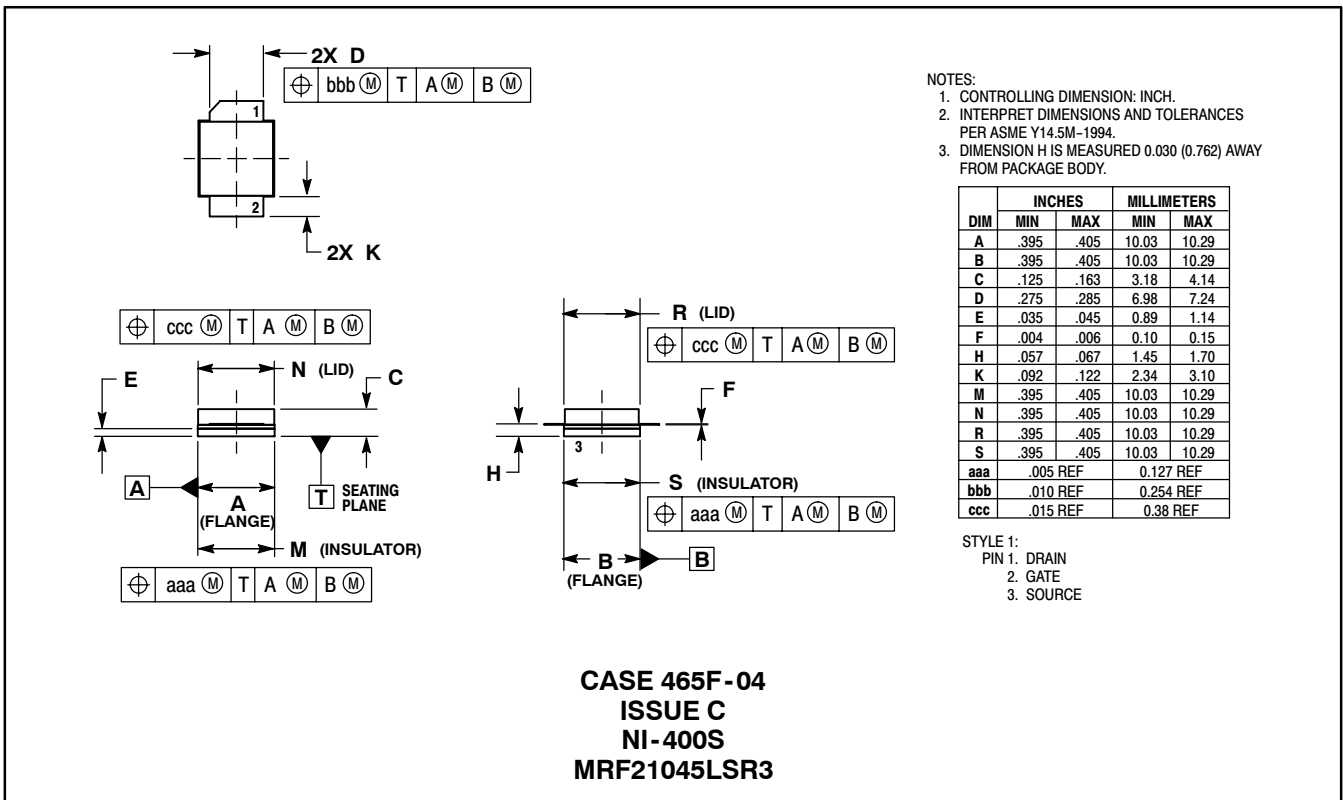
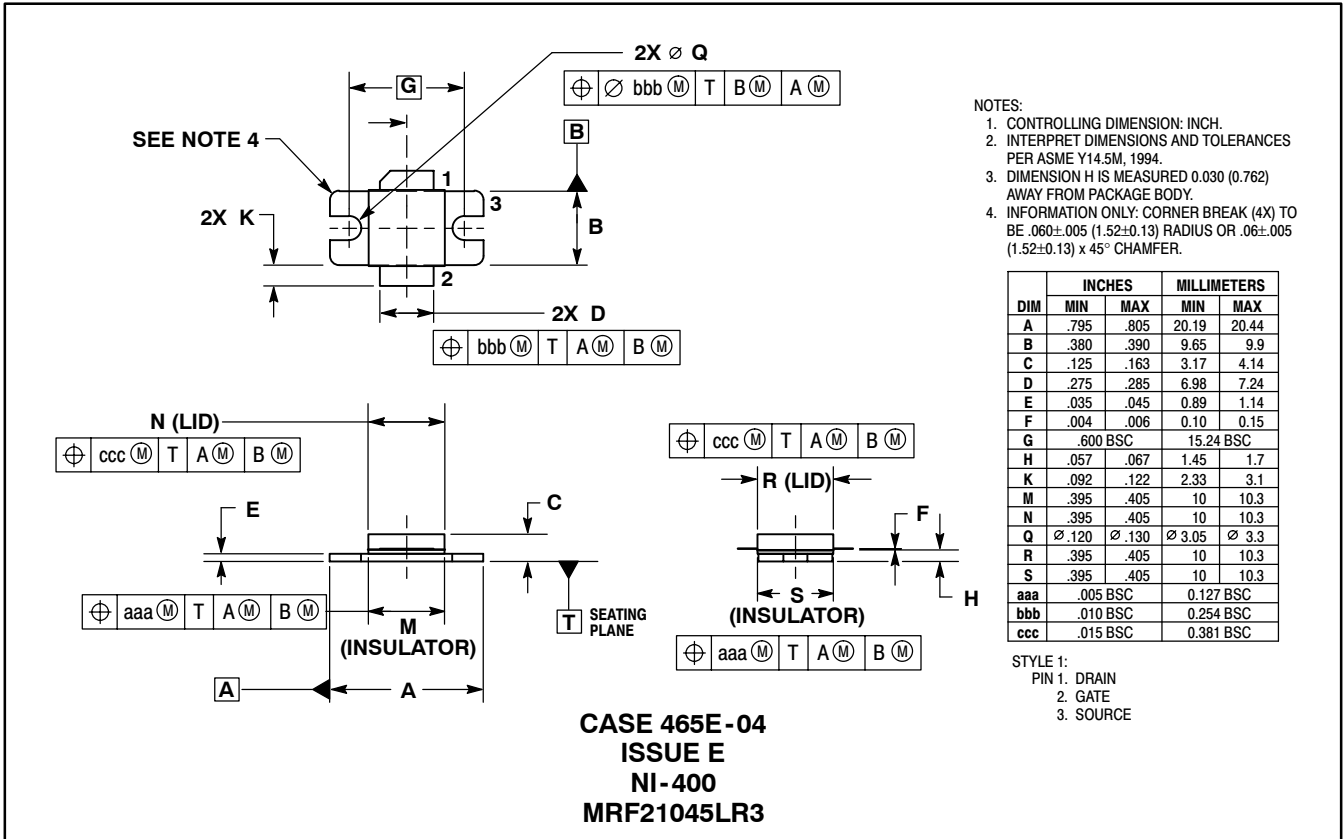

# Freescale Semiconductor, Inc.

Information in this document is provided solely to enable system and software implementers to use Motorola products. There are no express or implied copyright licenses granted hereunder to design or fabricate any integrated circuits or integrated circuits based on the information in this document.

Motorola reserves the right to make changes without further notice to any products herein. Motorola makes no warranty, representation or guarantee regarding the suitability of its products for any particular purpose, nor does Motorola assume any liability arising out of the application or use of any product or circuit, and specifically disclaims any and all liability, including without limitation consequential or incidental damages. "Typical" parameters that may be provided in Motorola data sheets and/or specifications can and do vary in different applications and actual performance may vary over time. All operating parameters, including "Typicals", must be validated for each customer application by customer's technical experts. Motorola does not convey any license under its patent rights nor the rights of others. Motorola products are not designed, intended, or authorized for use as components in systems intended for surgical implant into the body, or other applications intended to support or sustain life, or for any other application in which the failure of the Motorola product could create a situation where personal injury or death may occur. Should Buyer purchase or use Motorola products for any such unintended or unauthorized application, Buyer shall indemnify and hold Motorola and its officers, employees, subsidiaries, affiliates, and distributors harmless against all claims, costs, damages, and expenses, and reasonable attorney fees arising out of, directly or indirectly, any claim of personal injury or death associated with such unintended or unauthorized use, even if such claim alleges that Motorola was negligent regarding the design or manufacture of the part.

MOTOROLA and the Stylized M Logo are registered in the US Patent and Trademark Office. All other product or service names are the property of their respective owners. Motorola, Inc. is an Equal Opportunity/Affirmative Action Employer.

© Motorola Inc. 2004

## HOW TO REACH US:

### USA/EUROPE/LOCATIONS NOT LISTED:

Motorola Literature Distribution  
P.O. Box 5405, Denver, Colorado 80217  
1-800-521-6274 or 480-768-2130

**JAPAN:** Motorola Japan Ltd.; SPS, Technical Information Center,  
3-20-1, Minami-Azabu, Minato-ku, Tokyo 106-8573, Japan  
81-3-3440-3569

**ASIA/PACIFIC:** Motorola Semiconductors H.K. Ltd.; Silicon Harbour Centre,  
2 Dai King Street, Tai Po Industrial Estate, Tai Po, N.T., Hong Kong  
852-2668334

**HOME PAGE:** <http://motorola.com/semiconductors>