



**RF2304**

GENERAL PURPOSE LOW-NOISE AMPLIFIER

Typical Applications

- Receive or Transmit Low-Noise Amplifiers
- FDD and TDD Communication Systems
- Commercial and Consumer Systems
- Portable Battery Powered Equipment
- Wireless LAN
- ISM Band Applications

Product Description

The RF2304 is a low-noise small-signal amplifier. The device is manufactured on a low-cost Gallium Arsenide MESFET process, and has been designed for use as a gain block in high-end communication systems operating from less than 300MHz to above 2.5GHz. With +6dBm output power, it may also be used as a driver in transmitter applications, or in highly linear receivers. The device is packaged in an 8-lead plastic package and is self-contained, requiring just an inductor and blocking capacitors to operate. The +6dBm output power, combined with the 1.8dB noise figure at 900MHz allows excellent dynamic range for a variety of receive and transmit applications.

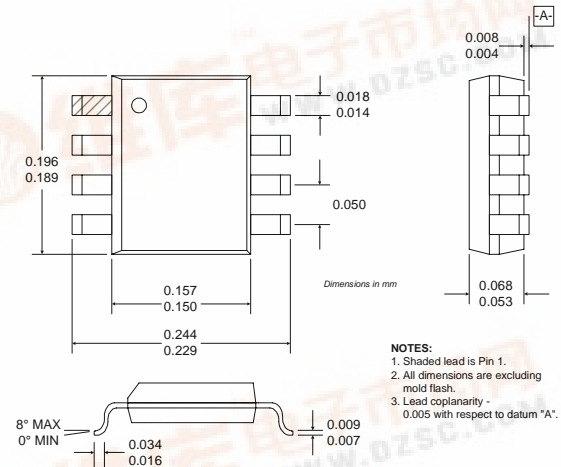

NOTES:  
 1. Shaded lead is Pin 1.  
 2. All dimensions are excluding mold flash.  
 3. Lead coplanarity - 0.005 with respect to datum "A".

Optimum Technology Matching® Applied

- Si BJT       GaAs HBT       GaAs MESFET  
 Si Bi-CMOS       SiGe HBT       Si CMOS

Package Style: SOIC-8

Features

- Single 2.7V to 6.0V Supply
- 6dBm Output Power
- 8dB Small Signal Gain at 900MHz
- 1.8dB Noise Figure at 900MHz
- Low DC Current Consumption of 5mA
- 300MHz to 2500MHz Operation

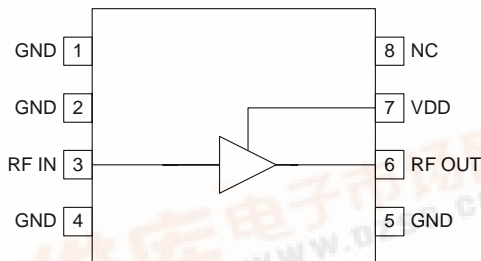

Functional Block Diagram

Ordering Information

RF2304      General Purpose Low-Noise Amplifier  
 RF2304 PCBA      Fully Assembled Evaluation Board

RF Micro Devices, Inc.  
 7628 Thorndike Road  
 Greensboro, NC 27409, USA

Tel (336) 664 1233  
 Fax (336) 664 0454  
<http://www.rfmd.com>

4  
GENERAL PURPOSE AMPLIFIERS



# RF2304

## Absolute Maximum Ratings

Parameter	Rating	Unit
Supply Voltage ( $V_{DD}$ )	-0.5 to +6.5	$V_{DC}$
DC Current	40	mA
Input RF Power	+10	dBm
Operating Ambient Temperature	-40 to +85	$^{\circ}C$
Storage Temperature	-40 to +150	$^{\circ}C$



**Caution!** ESD sensitive device.

RF Micro Devices believes the furnished information is correct and accurate at the time of this printing. However, RF Micro Devices reserves the right to make changes to its products without notice. RF Micro Devices does not assume responsibility for the use of the described product(s).

Parameter	Specification			Unit	Condition
	Min.	Typ.	Max.		
<b>Operating Range</b>					
Overall Frequency Range	300		2500	MHz	
Supply Voltage	2.7		6.0	V	
Operating Current ( $I_{CC}$ )		8.4		mA	$V_{CC}=3V$ , Temp= $27^{\circ}C$
	7	11	26	mA	$V_{CC}=5V$ , Temp= $27^{\circ}C$
Operating Ambient Temperature	-40		+85	$^{\circ}C$	
<b>3V Performance</b>					
Gain		11.7		dB	Freq=300MHz, $V_{CC}=3V$ , Temp= $27^{\circ}C$
Gain		8.5		dB	Freq=900MHz, $V_{CC}=3V$ , Temp= $27^{\circ}C$
Noise Figure		1.9		dB	
Input IP3		+6.9		dBm	
OP1dB		+7.5		dBm	
Gain		9.2		dB	Freq=1950MHz, $V_{CC}=3V$ , Temp= $27^{\circ}C$
Noise Figure		1.7		dB	
Input IP3		+8.6		dBm	
OP1dB		+6.9		dBm	
Gain		8.2		dB	Freq=2450MHz, $V_{CC}=3V$ , Temp= $27^{\circ}C$
Noise Figure		1.7		dB	
Input IP3		+10.5		dBm	
OP1dB		+7.5		dBm	
<b>5V Performance</b>					
Gain		12.5		dB	Freq=300MHz, $V_{CC}=5V$ , Temp= $27^{\circ}C$
Gain	10	12	14	dB	Freq=900MHz, $V_{CC}=5V$ , Temp= $27^{\circ}C$
Noise Figure		1.9		dB	
Input IP3		+8.4		dBm	
OP1dB		+8.7		dBm	
Gain		9.8		dB	Freq=1950MHz, $V_{CC}=5V$ , Temp= $27^{\circ}C$
Noise Figure		1.9		dB	
Input IP3		+10.0		dBm	
OP1dB		+8		dBm	
Gain	6	8	11	dB	Freq=2450MHz, $V_{CC}=5V$ , Temp= $27^{\circ}C$
Noise Figure		1.6		dB	
Input IP3		+8.0		dBm	
OP1dB		+6		dBm	

# RF2304

Pin	Function	Description	Interface Schematic
1	GND	Ground connection. For best performance, keep traces physically short and connect immediately to ground plane.	
2	GND	Same as pin 1.	
3	RF IN	DC coupled RF input. A broadband impedance match is produced by internal shunt resistive feedback. The DC level is approximately 200mV. If a DC path exists in the connected circuitry, an external DC-blocking capacitor is required to properly maintain the DC operating point.	
4	GND	Same as pin 1.	
5	GND	Same as pin 1.	
6	RF OUT	RF output. A broadband impedance match is produced by internal shunt resistive feedback. The DC connection to the power supply is provided through an external chip inductor having greater than 150Ω reactance at the operating frequency. An external DC-blocking capacitor is required if the following circuitry is not DC-blocked.	
7	VDD2	Bias control connection. This pin is normally connected to the power supply, but can be used to switch the amplifier on and off by switching between power supply voltage and ground. This pin sinks approximately 600μA when connected to V <sub>DD</sub> , and sources less than 10μA when grounded.	
8	NC	No connection.	

4

GENERAL PURPOSE  
AMPLIFIERS

## Application Schematic

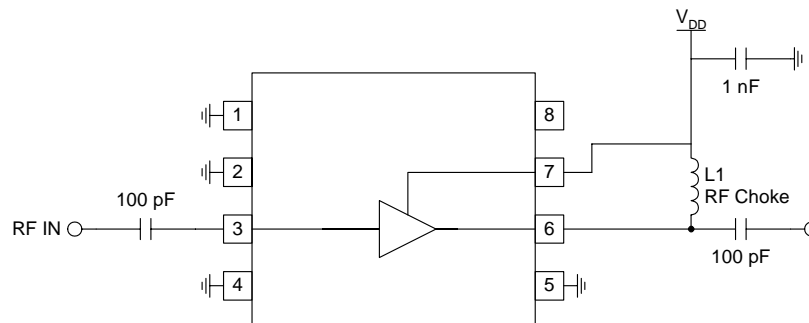

# RF2304

## Evaluation Board Schematic

(Download [Bill of Materials](http://www.rfmd.com) from [www.rfmd.com](http://www.rfmd.com).)

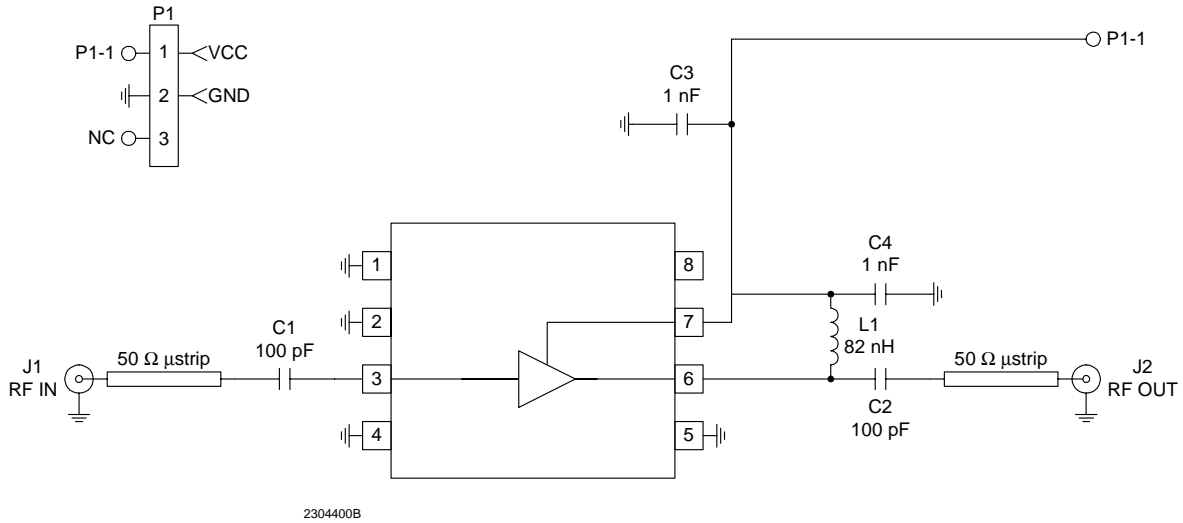

## Evaluation Board Layout 1.43" x 1.43"

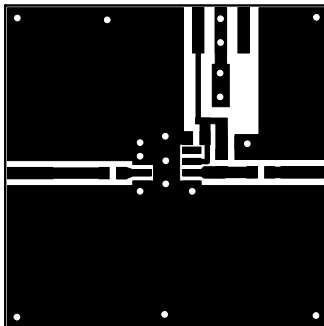
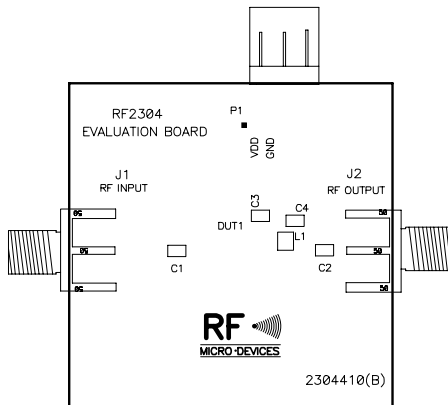

Typical Characteristics -  $f = 900\text{MHz}$

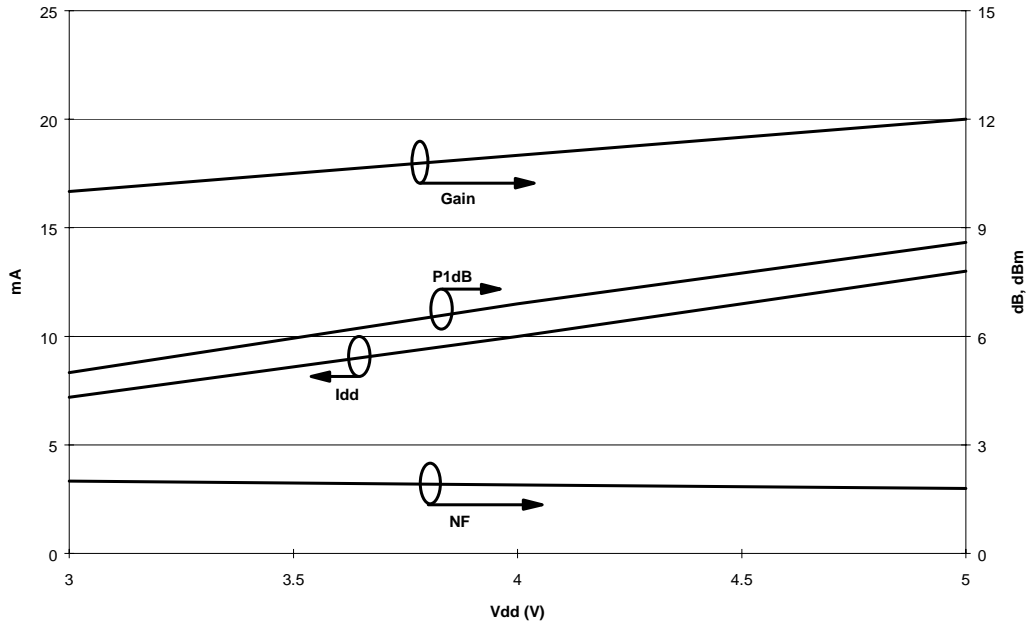

Typical Characteristics -  $V_{DD} = 5.0\text{V}$

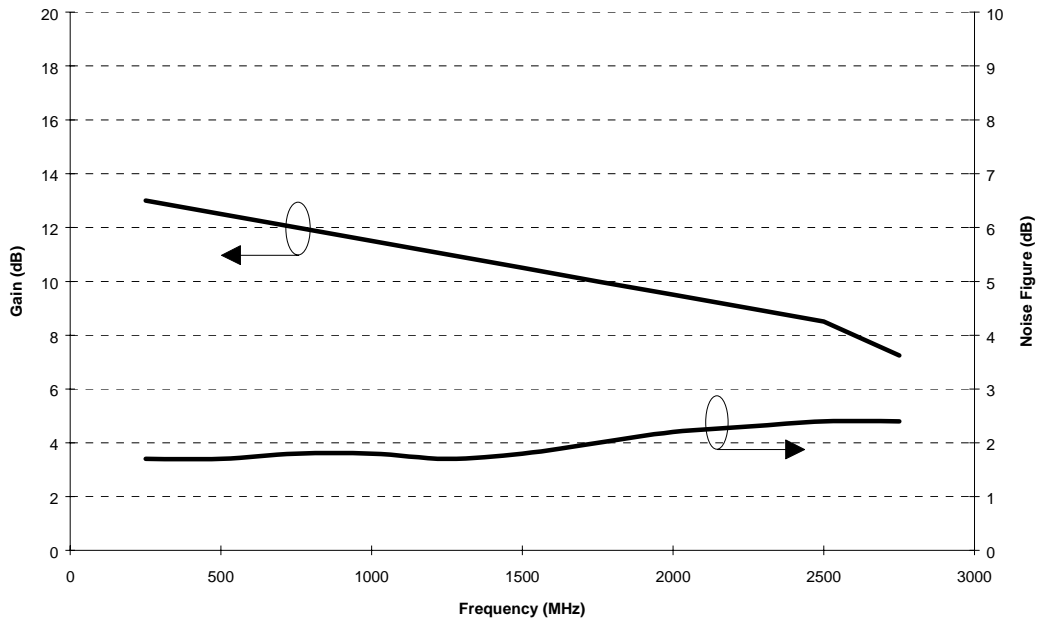

# RF2304

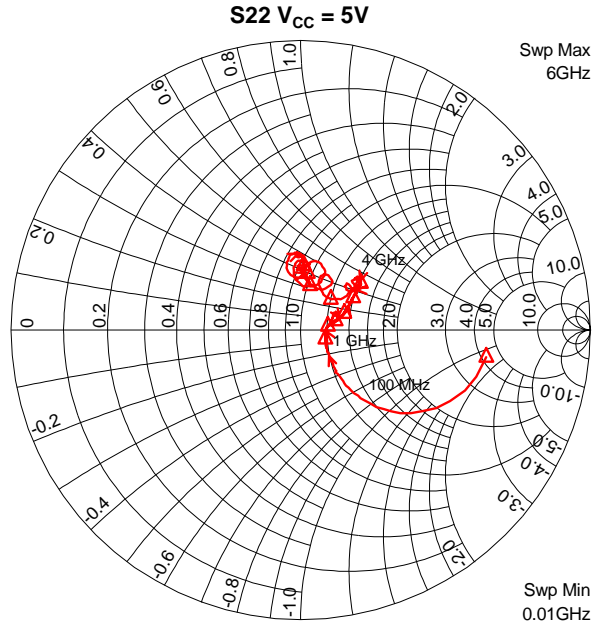
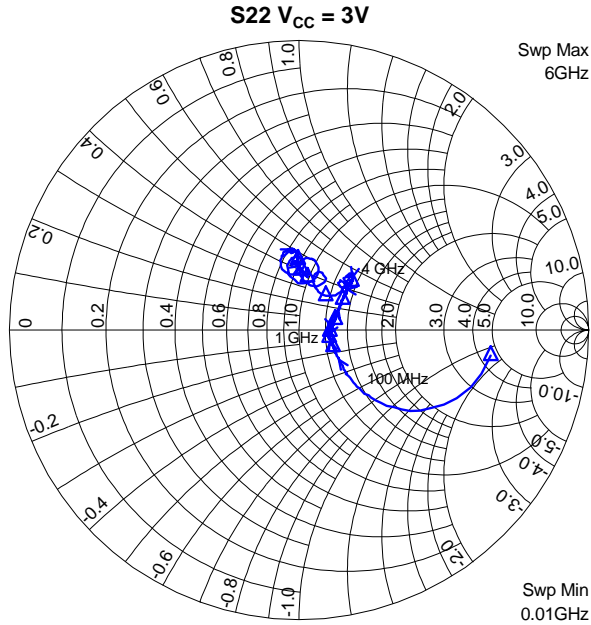
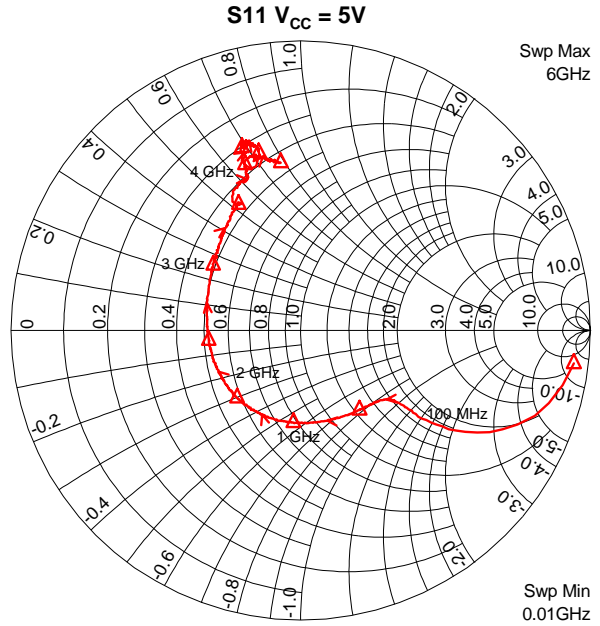
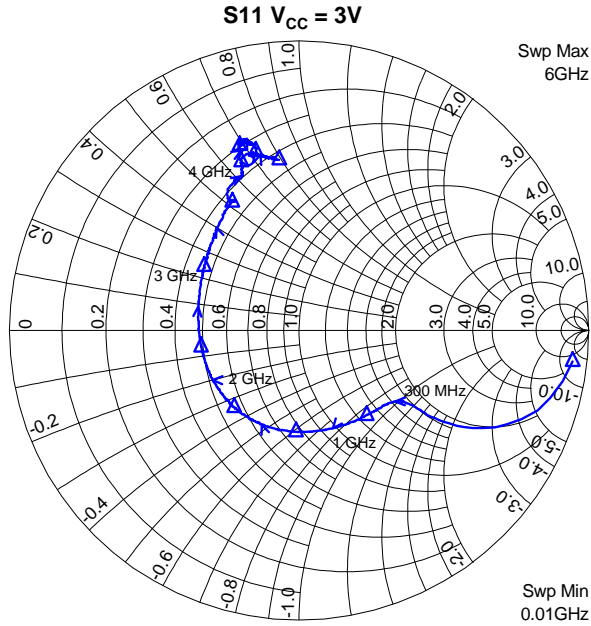

S-Parameter Conditions:  
All plots are taken at ambient temperature=25°C.

NOTE:  
All S11 and S22 plots shown were taken from an RF2304 evaluation board with external input and output tuning components removed and the reference points at the RF IN and RF OUT pins.

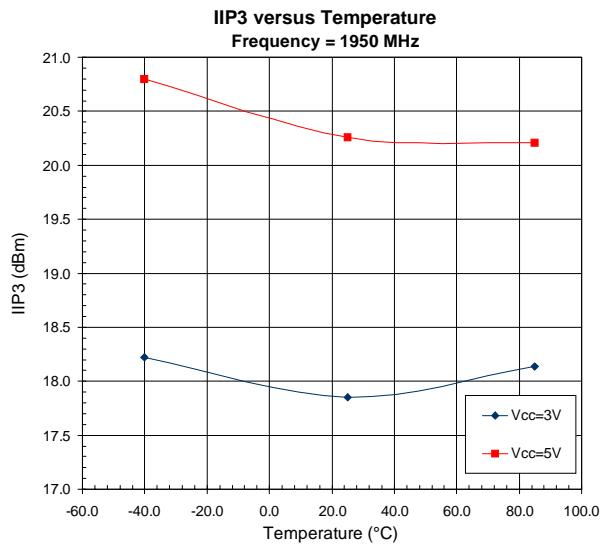
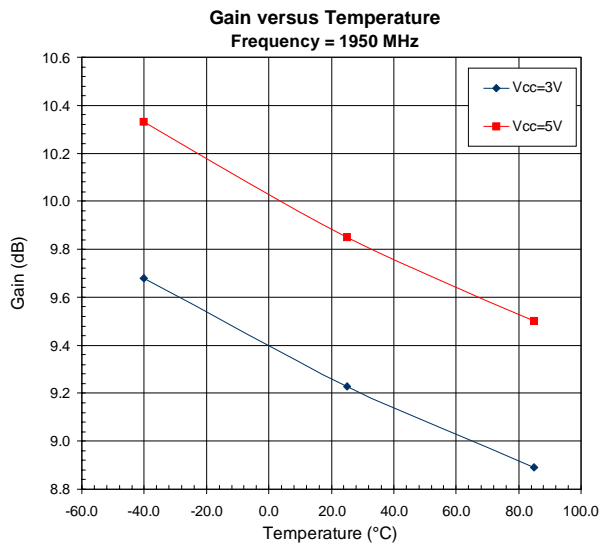
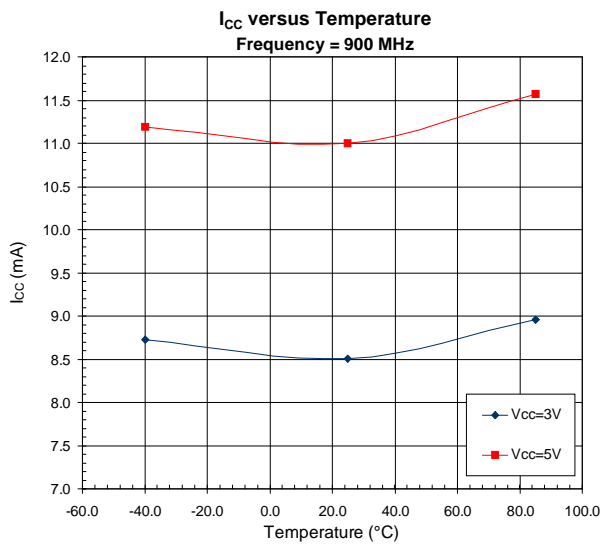
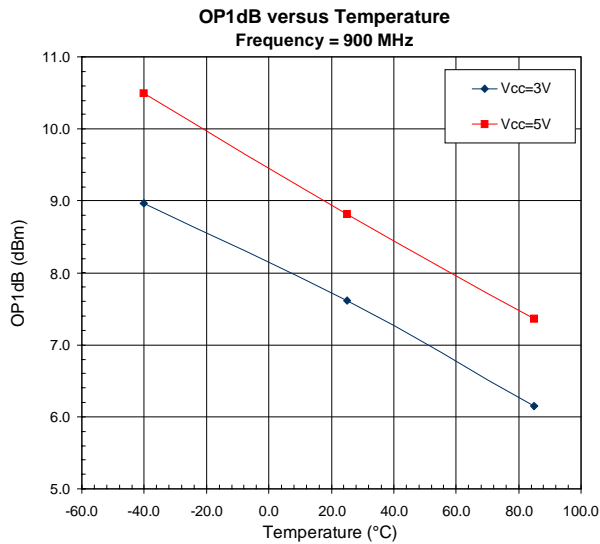
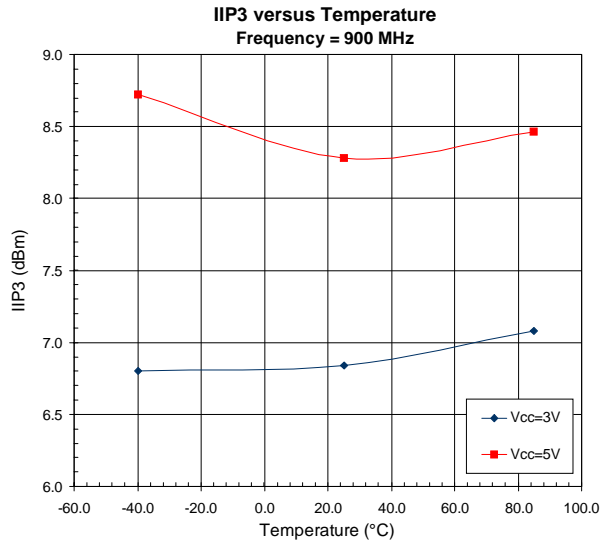
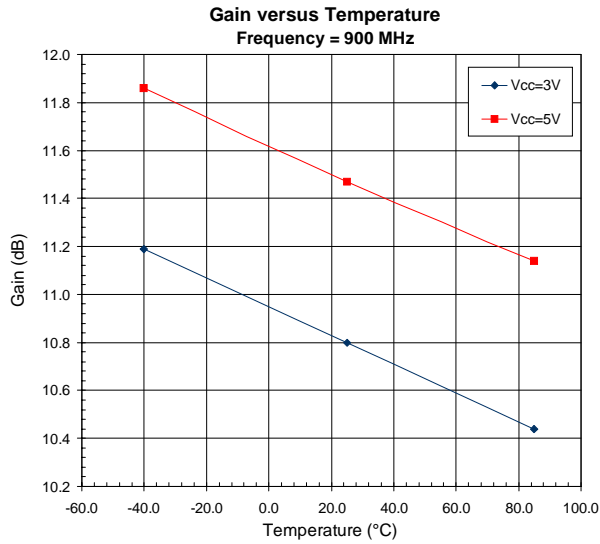

# RF2304

**OP1dB versus Temperature**  
Frequency = 1950 MHz

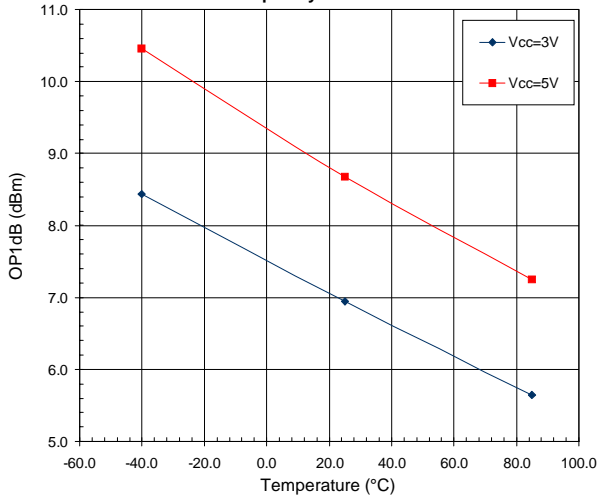

**I<sub>CC</sub> versus Temperature**  
Frequency = 1950 MHz

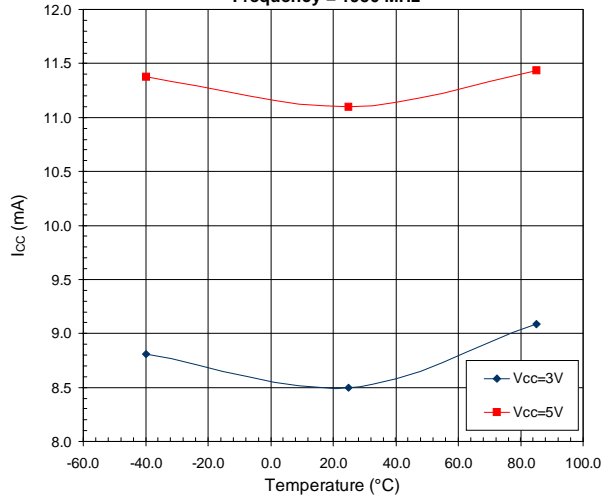

**Gain versus Temperature**  
Frequency = 2450 MHz

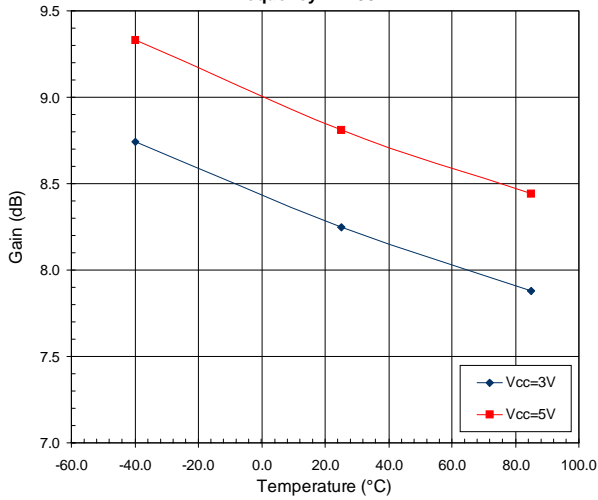

**IIP3 versus Temperature**  
Frequency = 2450 MHz

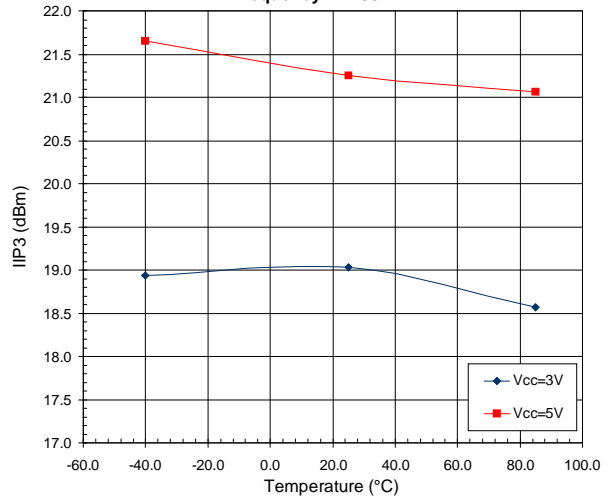

**OP1dB versus Temperature**  
Frequency = 2450 MHz

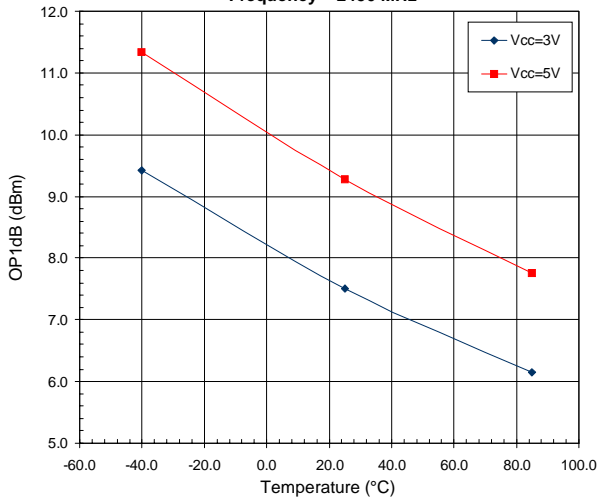

**I<sub>CC</sub> versus Temperature**  
Frequency = 2450 MHz

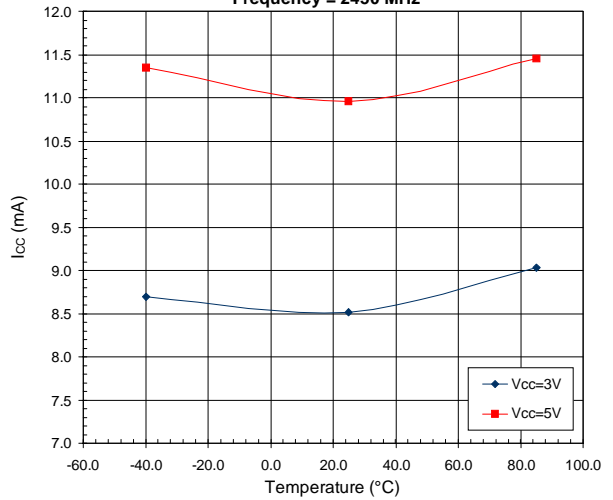



**S11 of Evaluation Board versus Frequency**  
Temperature = +25°C

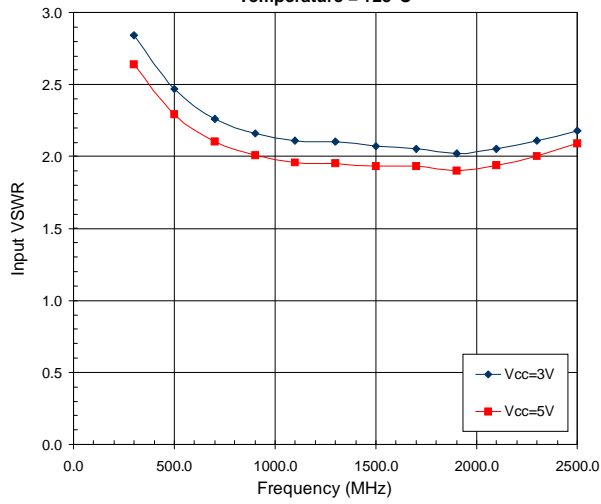

**S22 of Evaluation Board versus Frequency**  
Temperature = +25°C

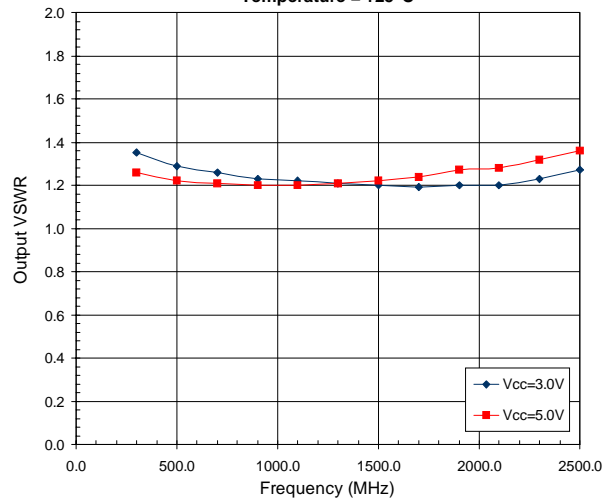

**Reverse Isolation (S12) of Evaluation Board versus Frequency, Temperature = +25°C**

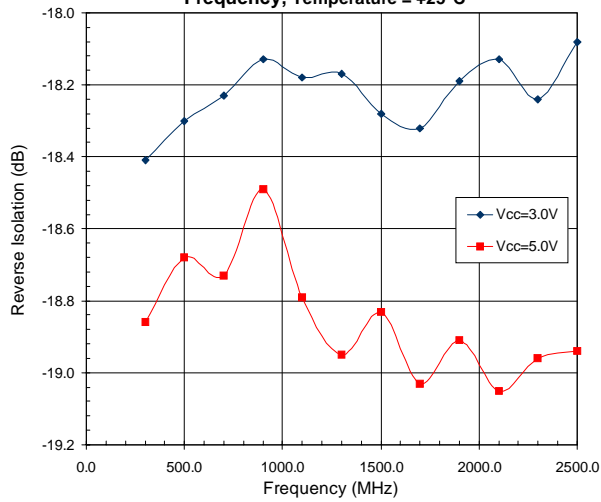

**RF2304**

**4**

**GENERAL PURPOSE  
AMPLIFIERS**