



RF2333

GENERAL PURPOSE AMPLIFIER

Typical Applications

- Broadband, Low Noise Gain Blocks
- IF or RF Buffer Amplifiers
- Driver Stage for Power Amplifiers
- Final PA for Low Power Applications
- Broadband Test Equipment

Product Description

The RF2333 is a general purpose, low-cost RF amplifier IC. The device is manufactured on an advanced Gallium Arsenide Heterojunction Bipolar Transistor (HBT) process, and has been designed for use as an easily-cascadable 50Ω gain block. Applications include IF and RF amplification in wireless voice and data communication products operating in frequency bands up to 6000MHz. The device is self-contained with 50Ω input and output impedances and requires only two external DC biasing elements to operate as specified. The RF2333 is available in a very small industry-standard SOT23 5-lead surface mount package, enabling compact designs which conserve board space.

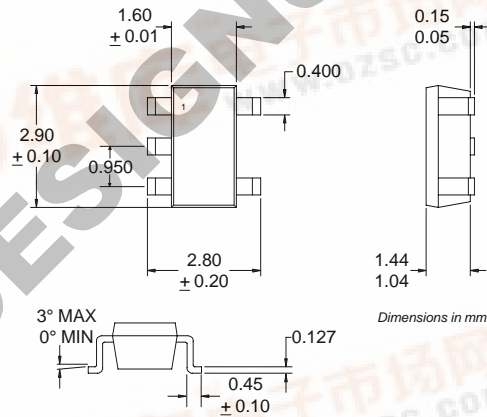

4
GENERAL PURPOSE AMPLIFIERS

Optimum Technology Matching® Applied

- Si BJT GaAs HBT GaAs MESFET
 Si Bi-CMOS SiGe HBT Si CMOS

Package Style: SOT 5 Lead

Features

- DC to 6000MHz Operation
- Internally matched Input and Output
- 10dB Small Signal Gain
- +34dBm Output IP3
- +18.5dBm Output Power
- Good Gain Flatness

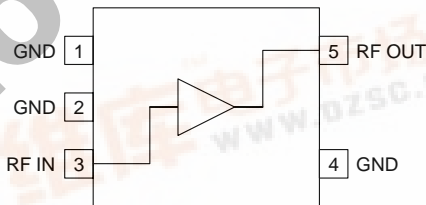

Functional Block Diagram

Ordering Information

- RF2333 General Purpose Amplifier
 RF2333 PCBA Fully Assembled Evaluation Board

RF Micro Devices, Inc.
7625 Thorndike Road
Greensboro, NC 27409, USA

Tel (336) 664 1233
Fax (336) 664 0454
<http://www.rfmd.com>



RF2333

Absolute Maximum Ratings

Parameter	Rating	Unit
Supply Current	120	mA
Input RF Power	+20	dBm
Operating Ambient Temperature	-40 to +65	°C
Storage Temperature	-60 to +150	°C



Caution! ESD sensitive device.

RF Micro Devices believes the furnished information is correct and accurate at the time of this printing. However, RF Micro Devices reserves the right to make changes to its products without notice. RF Micro Devices does not assume responsibility for the use of the described product(s).

4
GENERAL PURPOSE
AMPLIFIERS

Parameter	Specification			Unit	Condition
	Min.	Typ.	Max.		
Overall					T=25°C, V _D =5.5V, I _{CC} =70mA
Frequency Range		DC to 6000		MHz	
3dB Bandwidth		6		GHz	
Gain		11.2		dB	Freq=100MHz
		11		dB	Freq=1000MHz
		10.4		dB	Freq=2000MHz
		10.2		dB	Freq=3000MHz
		10			Freq=4000MHz
		9.2			Freq=5000MHz
Gain Flatness		8.3			Freq=6000MHz
		±0.4		dB	100MHz to 2000MHz
Noise Figure		8.2		dB	Freq=2000MHz
Input VSWR		1.7:1			In a 50Ω system, DC to 4000MHz
Output VSWR		1.7:1			In a 50Ω system, DC to 4000MHz
Output IP ₃		+34.5		dBm	Freq=1000MHz±50kHz, P _{TONE} =-10dBm
Output P _{1dB}		+18.5		dBm	Freq=1000MHz
Reverse Isolation		17		dB	Freq=2000MHz
Power Supply					With 22Ω bias resistor
Device Operating Voltage	5.0	5.5	6.0	V	At pin 5 with I _{CC} =70mA
Operating Current		70		mA	

Pin	Function	Description	Interface Schematic
1	GND	Ground connection. Keep traces physically short and connect immediately to ground plane for best performance.	
2	GND	Same as pin 1.	
3	RF IN	RF input pin. This pin is NOT internally DC blocked. A DC blocking capacitor, suitable for the frequency of operation, should be used in most applications. DC coupling of the input is not allowed, because this will override the internal feedback loop and cause temperature instability.	
4	GND	Same as pin 1.	
5	RF OUT	RF output and bias pin. Biasing is accomplished with an external series resistor and choke inductor to V_{CC} . The resistor is selected to set the DC current into this pin to a desired level. The resistor value is determined by the following equation: $R = \frac{(V_{SUPPLY} - V_{DEVICE})}{I_{CC}}$ <p>Care should also be taken in the resistor selection to ensure that the current into the part never exceeds 120 mA over the planned operating temperature. This means that a resistor between the supply and this pin is always required, even if a supply near 5.5V is available, to provide DC feedback to prevent thermal runaway. Because DC is present on this pin, a DC blocking capacitor, suitable for the frequency of operation, should be used in most applications. The supply side of the bias network should also be well bypassed.</p>	

Evaluation Board Schematic

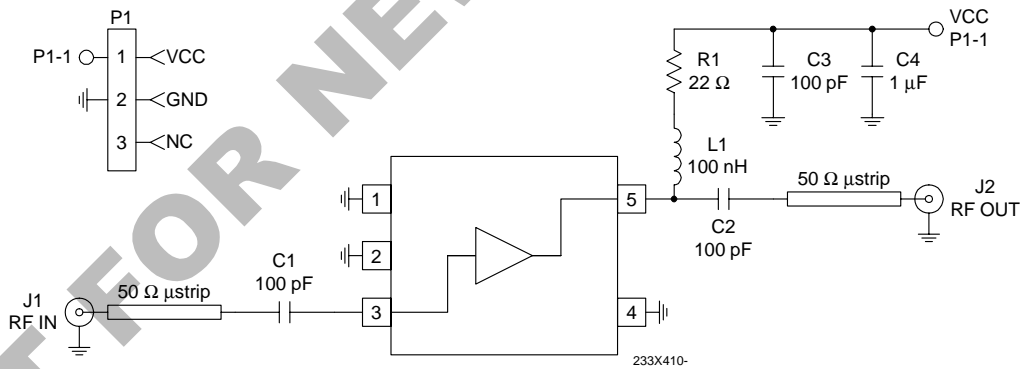

RF2333

Evaluation Board Layout Board Size 1" x 1"

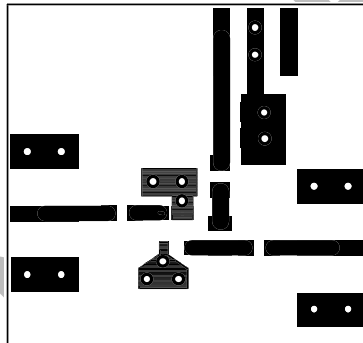
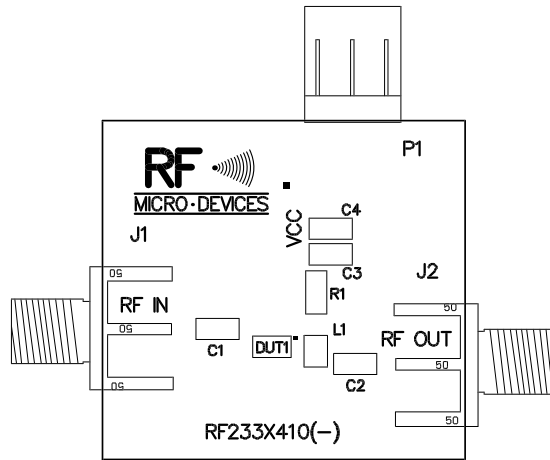

4

GENERAL PURPOSE
AMPLIFIERS

RF2333

RF2333 Gain vs. Frequency across Temperature
Icc = 70 mA

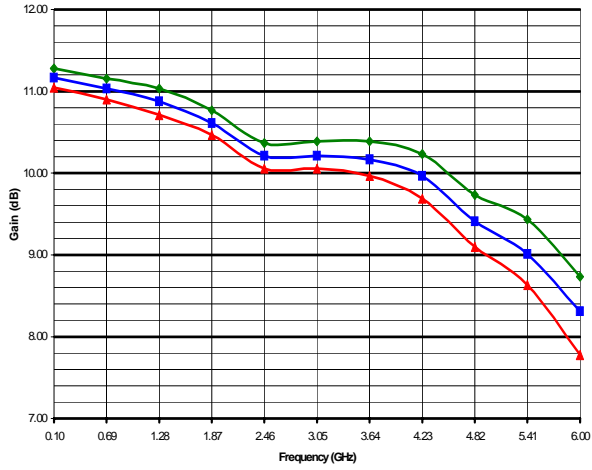

RF2333 Output P1dB vs. Frequency across Temperature
Icc = 70 mA

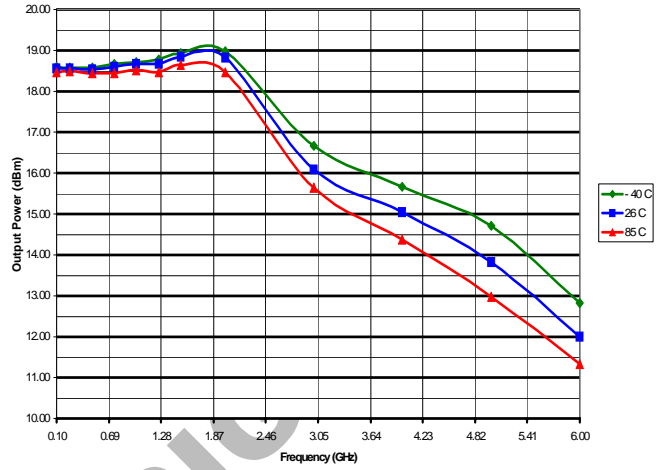

RF2333 Output IP3 vs. Frequency across Temperature
Icc = 70 mA

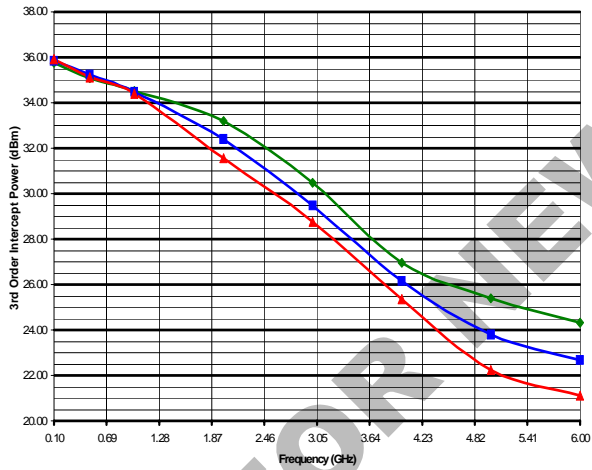

RF2333 Noise Figure vs. Frequency across Temperature
Icc = 70 mA

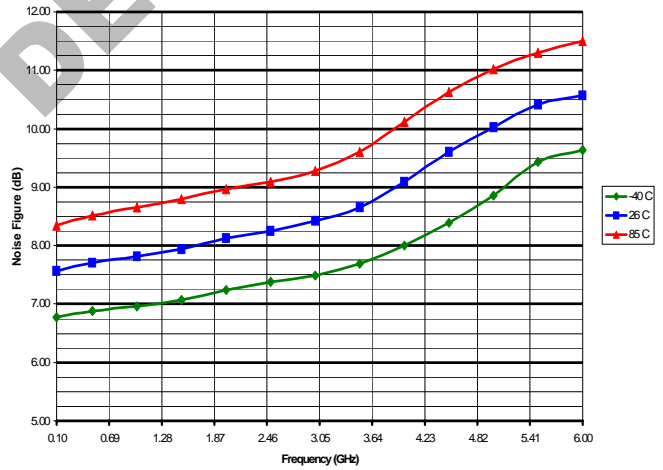

RF2333 Input VSWR vs. Frequency across Temperature
Icc = 70 mA

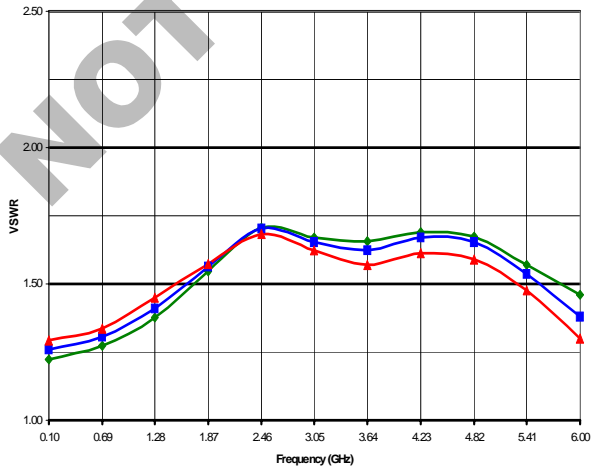

RF2333 Output VSWR vs. Frequency across Temperature
Icc = 70 mA

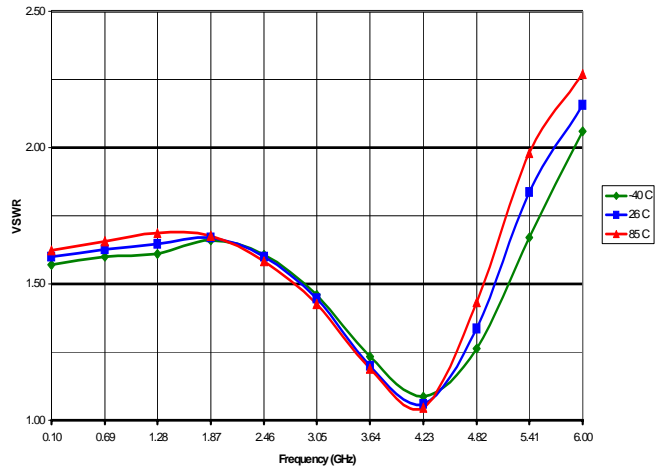

RF2333

RF2333 Reverse Isolation vs. Frequency across Temperature
I_{CC} = 70 mA

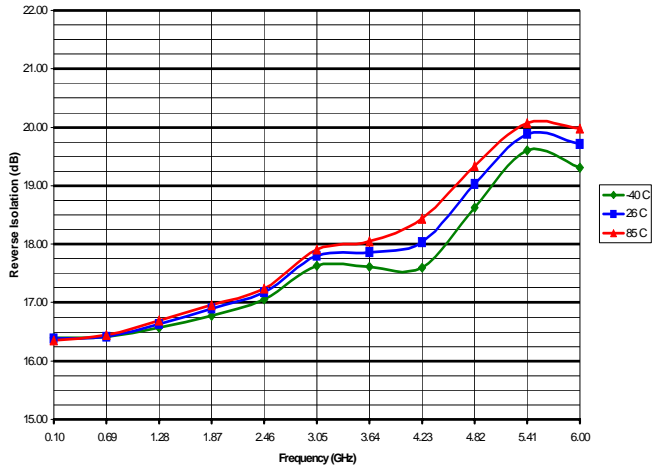

4

GENERAL PURPOSE
AMPLIFIERS

NOT FOR NEW DESIGNS