



RF2628

CDMA/FM UPCONVERTER/BPSK MODULATOR

Typical Applications

- CDMA/FM Cellular Systems
- Supports Dual-Mode AMPS/CDMA
- Supports Dual-Mode TACS/CDMA
- Commercial and Consumer Systems
- Battery-Operated Systems

Product Description

The RF2628 is a complete upconverter designed for CDMA/FM cellular applications. The IC contains a double-balanced mixer stage and an output buffer amplifier stage. This device may also be used to directly BPSK modulate a carrier. The mixer is a Gilbert cell with emitter degeneration resistors to provide high IP₃. The output stage is a class-B, push-pull configuration to reduce the overall current and still provide a good 50Ω output match. The unit operates at a supply voltage of 2.7V to 5.0V and does not require any external matching components other than coupling capacitors. This circuit is designed as part of the RFMD CDMA Chip Set, consisting of a Transmit IF AGC Amp, this Transmit Upconverter, a Receive LNA/Mixer, and a Receive IF AGC Amp.

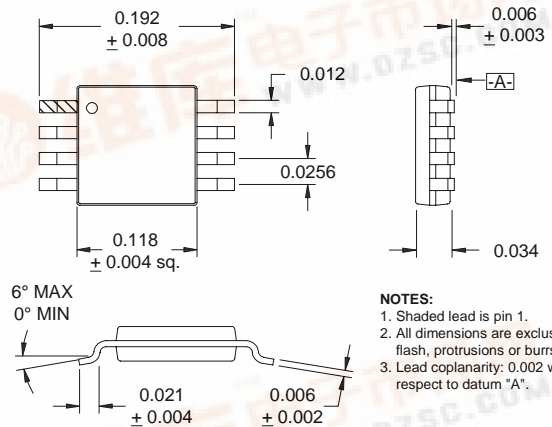

NOTES:
 1. Shaded lead is pin 1.
 2. All dimensions are exclusive of flash, protrusions or burrs.
 3. Lead coplanarity: 0.002 with respect to datum "A".

Optimum Technology Matching® Applied

- Si BJT GaAs HBT GaAs MESFET
 Si Bi-CMOS SiGe HBT Si CMOS

Package Style: MSOP-8

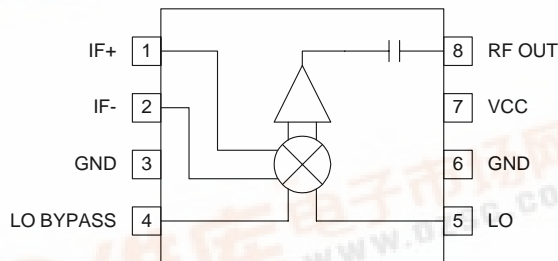

Functional Block Diagram

Features

- Supports Dual Mode Operation
- +9dBm Output Intercept Point
- Single 2.7V to 5.0V Power Supply
- Internally Matched Inputs and Outputs
- Buffered Output
- Double-Balanced Mixer

Ordering Information

RF2628 CDMA/FM Upconverter/BPSK Modulator
 RF2628 PCBA Fully Assembled Evaluation Board

RF Micro Devices, Inc.
 7628 Thorndike Road
 Greensboro, NC 27409, USA

Tel (336) 664 1233
 Fax (336) 664 0454
<http://www.rfmd.com>



RF2628

Absolute Maximum Ratings

Parameter	Rating	Unit
Supply Voltage	-0.5 to 5.5	V _{DC}
Input RF Power	+20	dBm
Operating Ambient Temperature	-40 to +85	°C
Storage Temperature	-40 to +150	°C



Caution! ESD sensitive device.

RF Micro Devices believes the furnished information is correct and accurate at the time of this printing. However, RF Micro Devices reserves the right to make changes to its products without notice. RF Micro Devices does not assume responsibility for the use of the described product(s).

Parameter	Specification			Unit	Condition
	Min.	Typ.	Max.		
Overall					T=25°C, V _{CC} =3.0V, RF=840MHz, LO=970MHz @ -2 dBm, IF=130MHz @ -15 dBm
RF Output Frequency Range	500	824 to 849	1500	MHz	
Conversion Gain	-2	0	+1	dB	
Noise Figure		15.5	18	dB	
Output IP3	+5	+9		dBm	
Output VSWR		1.6:1	1.8:1		50Ω
Spurious Product Rejection		30		dBc	Referenced to RF output
IF Input					
IF Frequency	DC	130	500	MHz	
Differential Input Impedance	215	265	315	Ω	
IF to RF Output Isolation	21	23		dB	IF=130MHz
IF to LO Isolation	40	45		dB	
LO Input					
LO Frequency Range	300	954 to 979	1700	MHz	
LO Level		-3 to +3		dBm	
LO to RF Output Leakage	-25	-28		dBm	
LO Input VSWR		1.1:1	1.5:1		50Ω
Power Supply					
Voltage		2.7 to 5.0		V	
Current Consumption		21	24	mA	V _{CC} =3.0V

RF2628

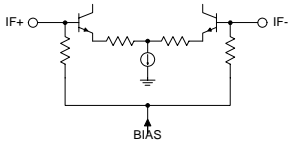
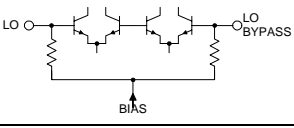
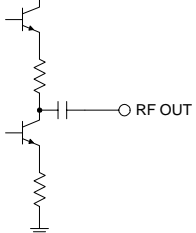
Pin	Function	Description	Interface Schematic
1	IF+	Balanced IF input pin. This pin is internally DC-biased and should be DC blocked if connected to a device with a DC level present. For single-ended input operation, one pin is used as an input and the other IF input is AC coupled to ground. The balanced, as well as single-ended, input impedance is 265Ω. The IF input should be used differentially when the part is used as a BPSK modulator.	
2	IF-	Same as pin 1, except complementary input.	See pin 1.
3	GND	Ground connection. For best performance, keep traces physically short and connect immediately to ground plane.	
4	LO BYPASS	Bypass connection for the LO. A capacitor of 100pF to ground should be connected to this pin	
5	LO	Balanced LO input pin. This pin is internally DC-biased and should be DC-blocked if connected to a device with a DC level present. For single-ended input operation, one pin is used as an input and the other LO input is AC-coupled to ground. The balanced, as well single-ended, input impedance is 50Ω.	See pin 4.
6	GND	Same as pin 3.	
7	VCC	Supply voltage pin. External bypassing is required. External RF, LO, and IF bypassing is required. The trace length between the pin and the bypass capacitors should be minimized. The ground side of the bypass capacitors should connect immediately to ground plane.	
8	RF OUT	RF output pin. This pin is internally DC-blocked. The output impedance is 50Ω.	

RF2628

Application Schematic

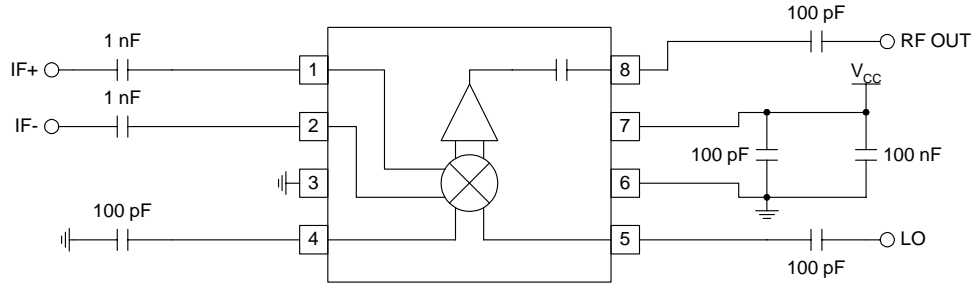

Evaluation Board Schematic

(Download [Bill of Materials](http://www.rfmd.com) from www.rfmd.com.)

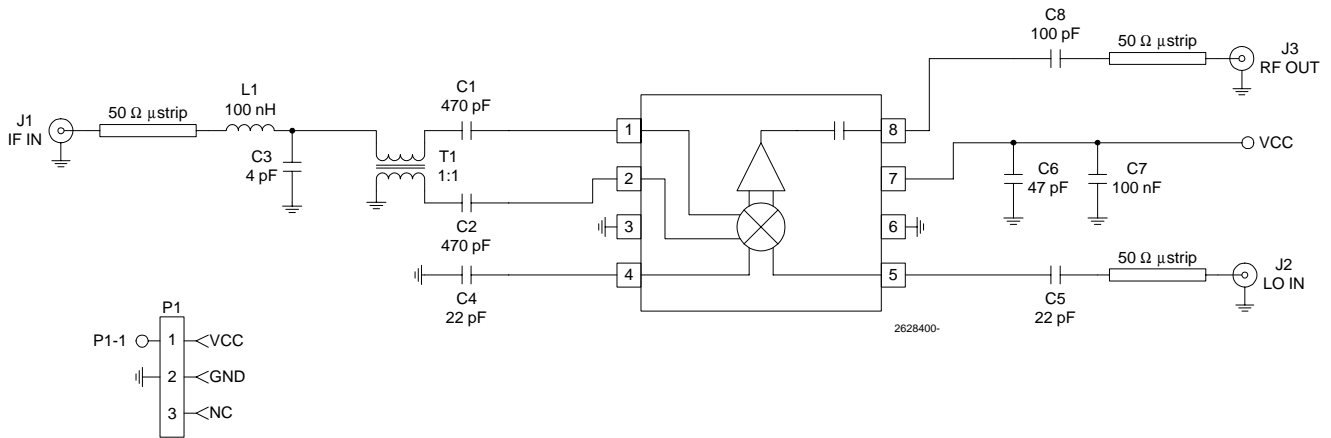

Evaluation Board Layout
Board Size 1.500" x 1.500"
Board Thickness 0.031", Board Material FR-4

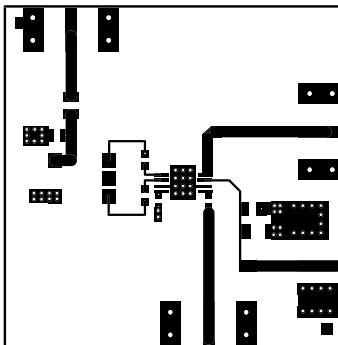
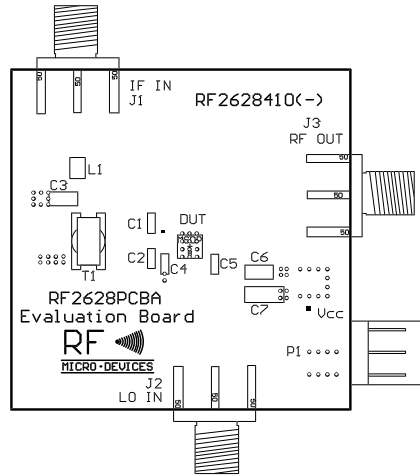

RF2628

6

MIXERS