

The RF Line

NPN Silicon Push-Pull RF Power Transistor

... designed primarily for wideband large-signal output and driver amplifier stages in the 30 to 500 MHz frequency range.

- Specified 28 Volt, 500 MHz Characteristics —
 - Output Power = 100 W
 - Typical Gain = 9.5 dB (Class AB); 8.5 dB (Class C)
 - Efficiency = 55% (Typ)
- Built-In Input Impedance Matching Networks for Broadband Operation
- Push-Pull Configuration Reduces Even Numbered Harmonics
- Gold Metallization System for High Reliability
- 100% Tested for Load Mismatch

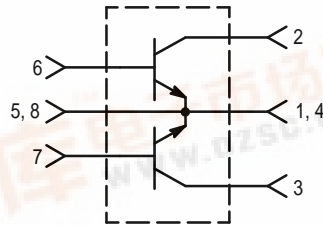

The MRF393 is two transistors in a single package with separate base and collector leads and emitters common. This arrangement provides the designer with a space saving device capable of operation in a push-pull configuration.

PUSH-PULL TRANSISTORS

MAXIMUM RATINGS

Rating	Symbol	Value	Unit
Collector-Emitter Voltage	V_{CEO}	30	Vdc
Collector-Base Voltage	V_{CBO}	60	Vdc
Emitter-Base Voltage	V_{EBO}	4.0	Vdc
Collector Current — Continuous	I_C	16	Adc
Total Device Dissipation @ $T_C = 25^\circ\text{C}$ (1) Derate above 25°C	P_D	270 1.54	Watts W/ $^\circ\text{C}$
Storage Temperature Range	T_{stg}	-65 to +150	$^\circ\text{C}$
Junction Temperature	T_J	200	$^\circ\text{C}$

THERMAL CHARACTERISTICS

Characteristic	Symbol	Max	Unit
Thermal Resistance, Junction to Case	$R_{\theta JC}$	0.65	$^\circ\text{C/W}$

NOTE:

- This device is designed for RF operation. The total device dissipation rating applies only when the device is operated as an RF push-pull amplifier.

MRF393

100 W, 30 to 500 MHz
CONTROLLED "Q"
BROADBAND PUSH-PULL
RF POWER TRANSISTOR
NPN SILICON

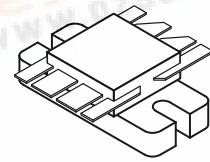

CASE 744A-01, STYLE 1

ELECTRICAL CHARACTERISTICS ($T_C = 25^\circ\text{C}$ unless otherwise noted.)

Characteristic	Symbol	Min	Typ	Max	Unit
OFF CHARACTERISTICS (1)					
Collector–Emitter Breakdown Voltage ($I_C = 50\text{ mAdc}$, $I_B = 0$)	$V_{(BR)CEO}$	30	—	—	Vdc
Collector–Emitter Breakdown Voltage ($I_C = 50\text{ mAdc}$, $V_{BE} = 0$)	$V_{(BR)CES}$	60	—	—	Vdc
Emitter–Base Breakdown Voltage ($I_E = 5.0\text{ mAdc}$, $I_C = 0$)	$V_{(BR)EBO}$	4.0	—	—	Vdc
Collector Cutoff Current ($V_{CB} = 30\text{ Vdc}$, $I_E = 0$)	I_{CBO}	—	—	5.0	mAdc

ON CHARACTERISTICS (1)

DC Current Gain ($I_C = 1.0\text{ Adc}$, $V_{CE} = 5.0\text{ Vdc}$)	h_{FE}	20	—	100	—
--	----------	----	---	-----	---

DYNAMIC CHARACTERISTICS (1)

Output Capacitance ($V_{CB} = 28\text{ Vdc}$, $I_E = 0$, $f = 1.0\text{ MHz}$)	C_{ob}	40	75	95	pF
--	----------	----	----	----	----

FUNCTIONAL TESTS (2) — See Figure 1

Common–Emitter Amplifier Power Gain ($V_{CC} = 28\text{ Vdc}$, $P_{out} = 100\text{ W}$, $f = 500\text{ MHz}$)	G_{pe}	7.5	8.5	—	dB
Collector Efficiency ($V_{CC} = 28\text{ Vdc}$, $P_{out} = 100\text{ W}$, $f = 500\text{ MHz}$)	η	50	55	—	%
Load Mismatch ($V_{CC} = 28\text{ Vdc}$, $P_{out} = 100\text{ W}$, $f = 500\text{ MHz}$, $VSWR = 30:1$, all phase angles)	ψ	No Degradation in Output Power			

NOTES:

- Each transistor chip measured separately.
- Both transistor chips operating in push–pull amplifier.

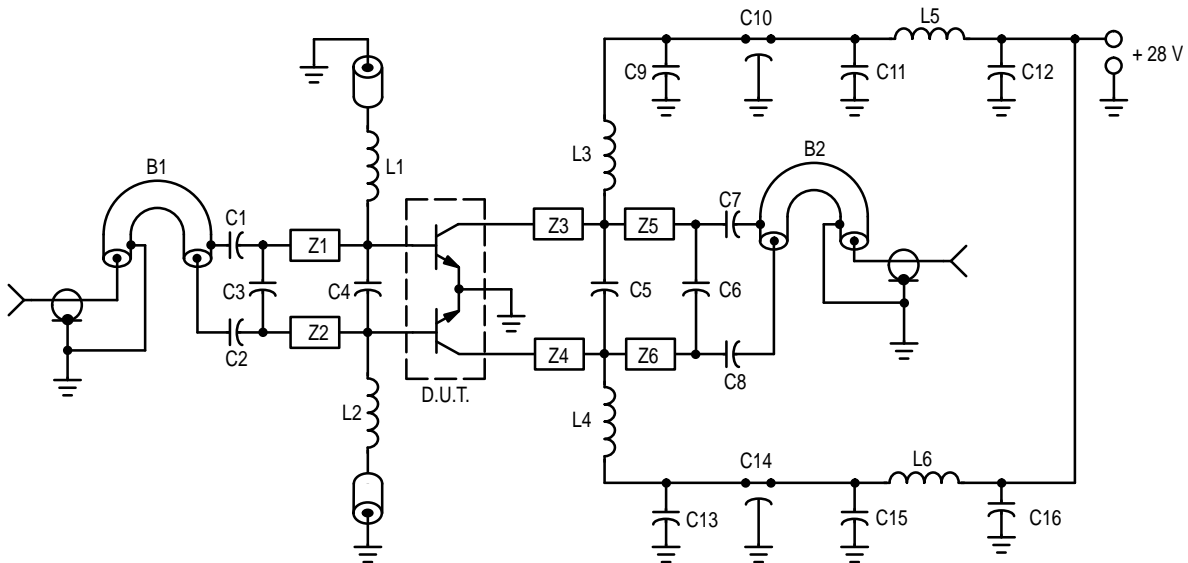

C1, C2, C7, C8 — 240 pF 100 mil Chip Cap
 C3 — 15 pF 100 mil Chip Cap
 C4 — 24 pF 100 mil Chip Cap
 C5 — 33 pF 100 mil Chip Cap
 C6 — 12 pF 100 mil Chip Cap
 C9, C13 — 1000 pF 100 mil Chip Cap
 C10, C14 — 680 pF Feedthru Cap
 C11, C15 — 0.1 μF Ceramic Disc Cap
 C12, C16 — 50 μF 50 V

L1, L2 — 0.15 μH Molded Choke with Ferrite Bead
 L3, L4 — 2–1/2 Turns #20 AWG 0.200" ID
 L5, L6 — 3–1/2 Turns #18 AWG 0.200" ID
 B1, B2 — Balun 50 Ω Semi Rigid Coax, 86 mil OD, 4" Long
 Z1, Z2 — 850 mil Long x 125 mil W. Microstrip
 Z3, Z4 — 200 mil Long x 125 mil W. Microstrip
 Z5, Z6 — 800 mil Long x 125 mil W. Microstrip
 Board Material — 0.0325" Teflon–Fiberglass, $\epsilon_r = 2.56$,
 1 oz. Copper Clad both sides.

Figure 1. 500 MHz Test Fixture

CLASS C

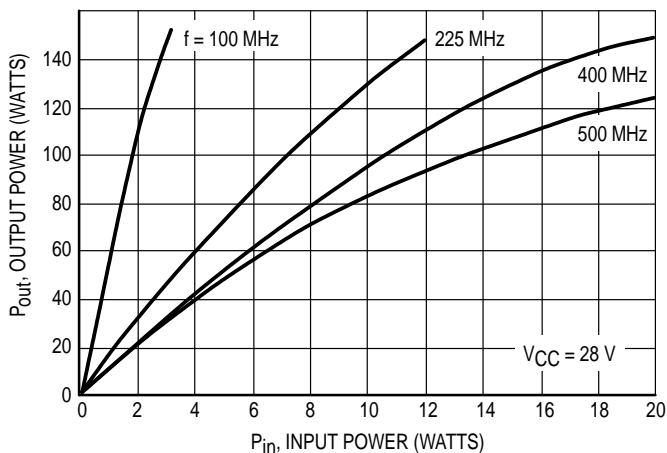

Figure 2. Output Power versus Input Power

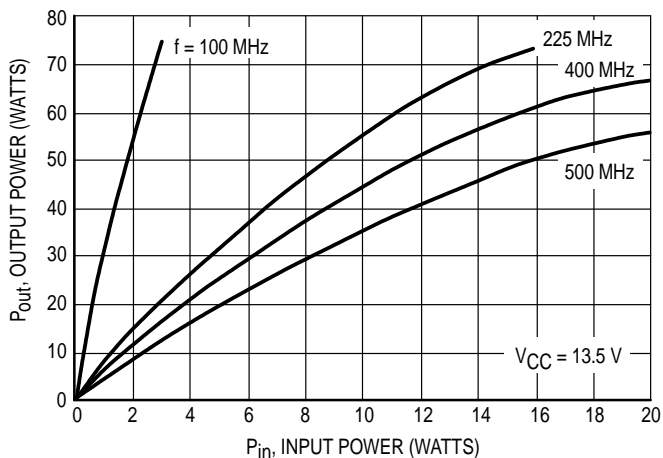

Figure 3. Output Power versus Input Power

CLASS C

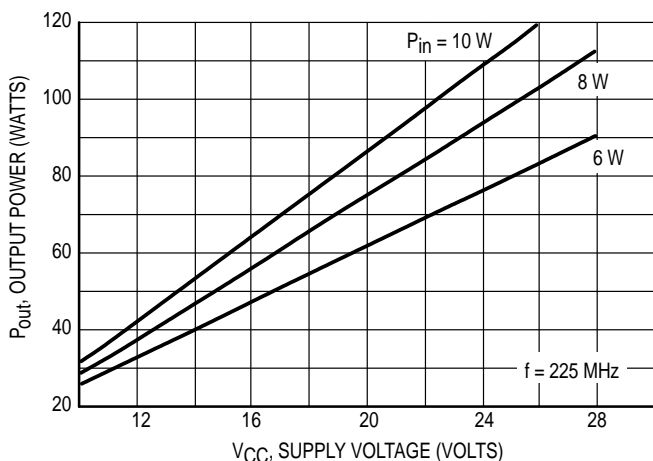

Figure 4. Output Power versus Supply Voltage

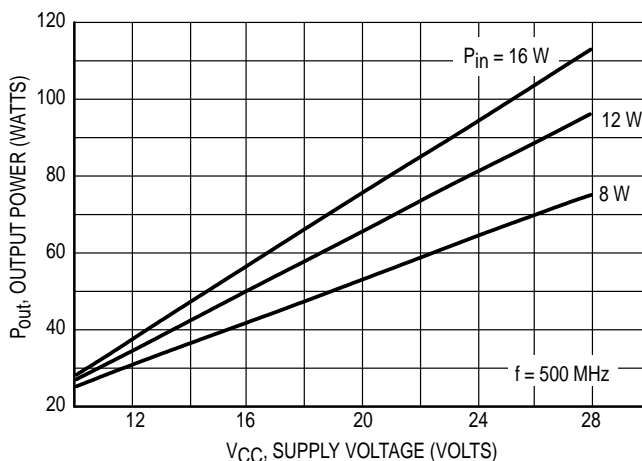
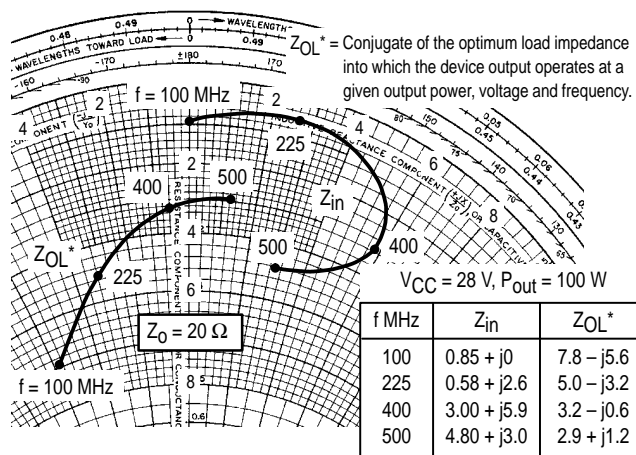

Figure 5. Output Power versus Supply Voltage



NOTE: Z_{in} & Z_{OL}* are given from base-to-base and collector-to-collector respectively.

Figure 6. Series Equivalent Input/Output Impedance

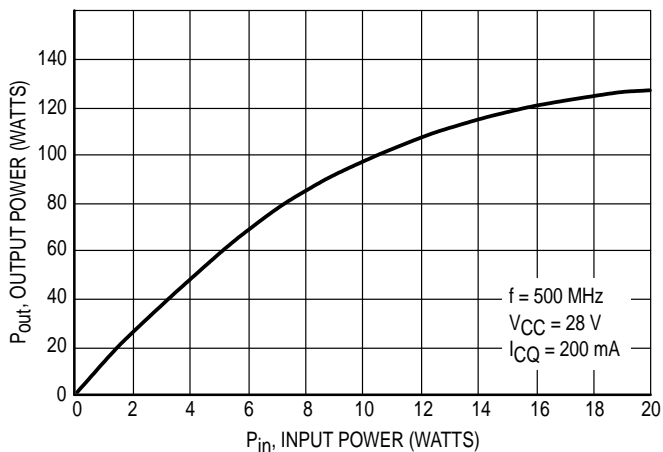
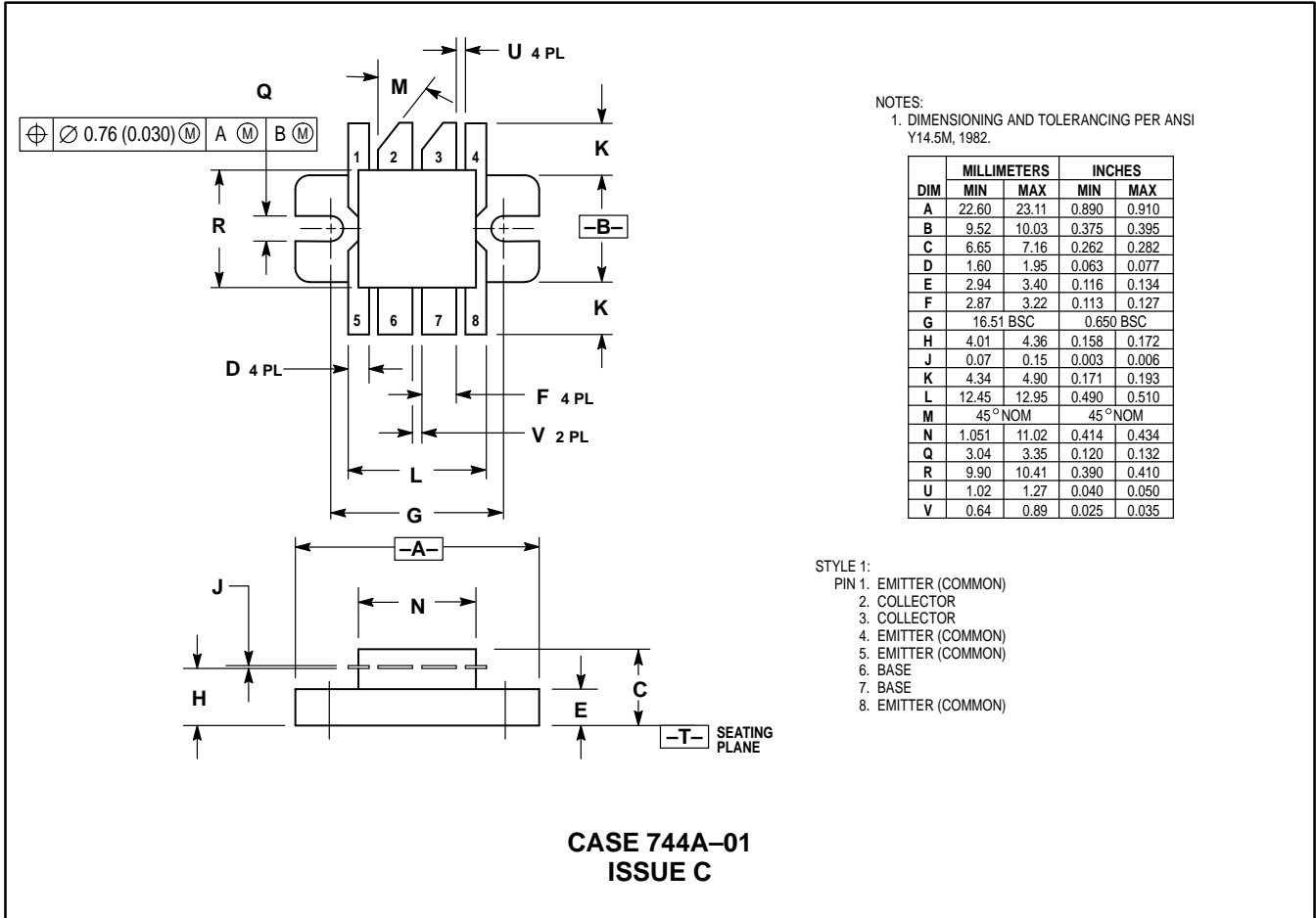

Figure 7. Class AB Output Power versus Input Power

PACKAGE DIMENSIONS



Specifications subject to change without notice.

- North America: Tel. (800) 366-2266, Fax (800) 618-8883
- Asia/Pacific: Tel.+81-44-844-8296, Fax +81-44-844-8298
- Europe: Tel. +44 (1344) 869 595, Fax+44 (1344) 300 020

Visit www.macom.com for additional data sheets and product information.