

The RF Line NPN Silicon RF Power Transistor

Designed primarily for high-voltage applications as a high-power linear amplifier from 2.0 to 30 MHz. Ideal for marine and base station equipment.

- Specified 50 Volt, 30 MHz Characteristics
 - Output Power = 250 W
 - Minimum Gain = 12 dB
 - Efficiency = 45%
- Intermodulation Distortion @ 250 W (PEP) —
 - IMD = -30 dB (Max)
- 100% Tested for Load Mismatch at all Phase Angles with 3:1 VSWR

MRF448

250 W, 30 MHz
RF POWER
TRANSISTOR
NPN SILICON

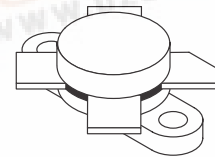

CASE 211-11, STYLE 1

MAXIMUM RATINGS

Rating	Symbol	Value	Unit
Collector-Emitter Voltage	V_{CEO}	50	Vdc
Collector-Base Voltage	V_{CBO}	100	Vdc
Emitter-Base Voltage	V_{EBO}	4.0	Vdc
Collector Current — Continuous	I_C	16	Adc
Withstand Current — 10 s	—	20	Adc
Total Device Dissipation @ $T_C = 25^\circ\text{C}$ (1) Derate above 25°C	P_D	290 1.67	Watts $\text{W}/^\circ\text{C}$
Storage Temperature Range	T_{stg}	-65 to +150	$^\circ\text{C}$

THERMAL CHARACTERISTICS

Characteristic	Symbol	Max	Unit
Thermal Resistance, Junction to Case	$R_{\theta JC}$	0.6	$^\circ\text{C}/\text{W}$

ELECTRICAL CHARACTERISTICS ($T_C = 25^\circ\text{C}$ unless otherwise noted.)

Characteristic	Symbol	Min	Typ	Max	Unit
----------------	--------	-----	-----	-----	------

OFF CHARACTERISTICS

Collector-Emitter Breakdown Voltage ($I_C = 200 \text{ mAdc}$, $I_B = 0$)	$V_{(BR)CEO}$	50	—	—	Vdc
Collector-Emitter Breakdown Voltage ($I_C = 100 \text{ mAdc}$, $V_{BE} = 0$)	$V_{(BR)CES}$	100	—	—	Vdc
Collector-Base Breakdown Voltage ($I_C = 100 \text{ mAdc}$, $I_E = 0$)	$V_{(BR)CBO}$	100	—	—	Vdc
Emitter-Base Breakdown Voltage ($I_E = 10 \text{ mAdc}$, $I_C = 0$)	$V_{(BR)EBO}$	4.0	—	—	Vdc

NOTE:

P_D is a measurement reflecting short term maximum condition. See SOAR curve for operating conditions.

(continued)

ELECTRICAL CHARACTERISTICS — continued ($T_C = 25^\circ\text{C}$ unless otherwise noted.)

Characteristic	Symbol	Min	Typ	Max	Unit
----------------	--------	-----	-----	-----	------

ON CHARACTERISTICS

DC Current Gain ($I_C = 5.0 \text{ Adc}$, $V_{CE} = 10 \text{ Vdc}$)	h_{FE}	10	30	—	—
--	----------	----	----	---	---

DYNAMIC CHARACTERISTICS

Output Capacitance ($V_{CB} = 50 \text{ Vdc}$, $I_E = 0$, $f = 1.0 \text{ MHz}$)	C_{ob}	—	350	450	μF
---	----------	---	-----	-----	---------------

FUNCTIONAL TESTS

Common-Emitter Amplifier Power Gain ($V_{CC} = 50 \text{ Vdc}$, $P_{out} = 250 \text{ W CW}$, $f = 30 \text{ MHz}$, $I_{CQ} = 250 \text{ mA}$)	G_{PE}	12	14	—	dB
Collector Efficiency ($V_{CC} = 50 \text{ Vdc}$, $P_{out} = 250 \text{ W}$, $f = 30 \text{ MHz}$, $I_{CQ} = 250 \text{ mA}$)	η	—	45 65	—	% (PEP) % (CW)
Intermodulation Distortion (2) ($V_{CE} = 50 \text{ Vdc}$, $P_{out} = 250 \text{ W (PEP)}$, $I_{CQ} = 250 \text{ mA}$, $f = 30 \text{ MHz}$)	IMD	—	-33	-30	dB
Electrical Ruggedness ($V_{CC} = 50 \text{ Vdc}$, $P_{out} = 250 \text{ W CW}$, $f = 30 \text{ MHz}$, VSWR 3:1 at all Phase Angles)	ψ	No Degradation in Output Power			

NOTE:

2. To Mil-Std-1311 Version A, Test Method 2204, Two Tone, Reference each Tone.

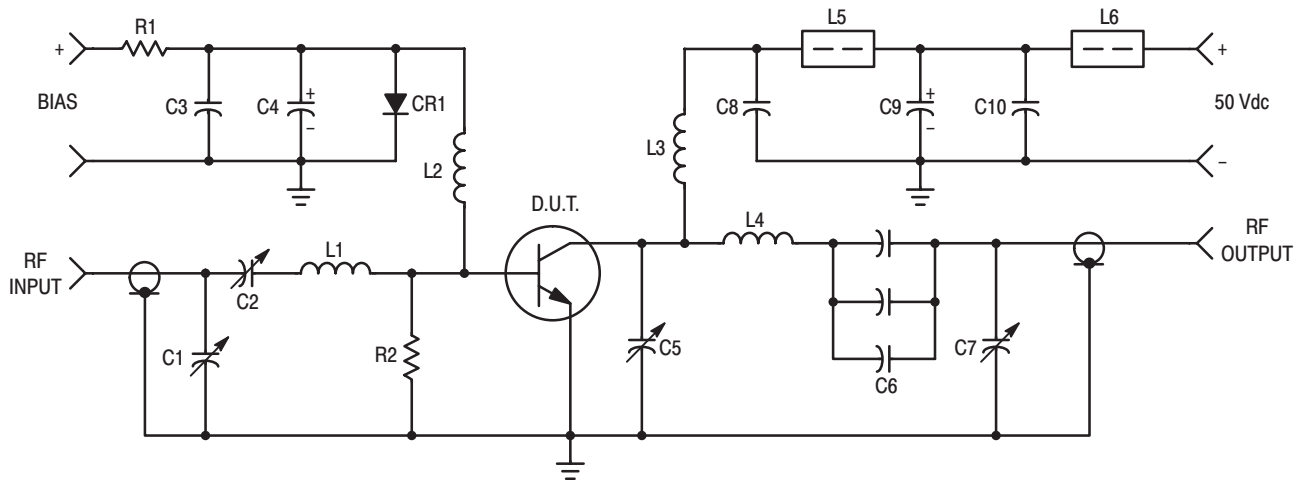

C1, C2, C5, C7 — 170–780 pF, Arco 469
 C3, C8, C9 — 0.1 μF , 100 V Erie
 C4 — 500 μF @ 6.0 V
 C6 — 360 pF, 3 x 120 pF 3.0 kV in parallel
 C10 — 10 μF , 100 V
 R1 — 10 Ω , 10 Watt
 R2 — 10 Ω , 1.0 Watt

CR1 — 1N4997 or equivalent
 L1 — 3 Turns, #16 Wire, 0.4" I.D., 0.3" Long
 L2 — 0.8 μH , Ohmite Z-235 or equivalent
 L3 — 12 Turns, #16 Enameled Wire Closewound 0.25" I.D.
 L4 — 4 Turns, 1/8" Copper Tubing, 0.6" I.D., 1.0" Long
 L5, L6 — 2.0 μH , Fair-Rite 2643021801 Ferrite bead each or equivalent

Figure 1. 30 MHz Test Circuit Schematic

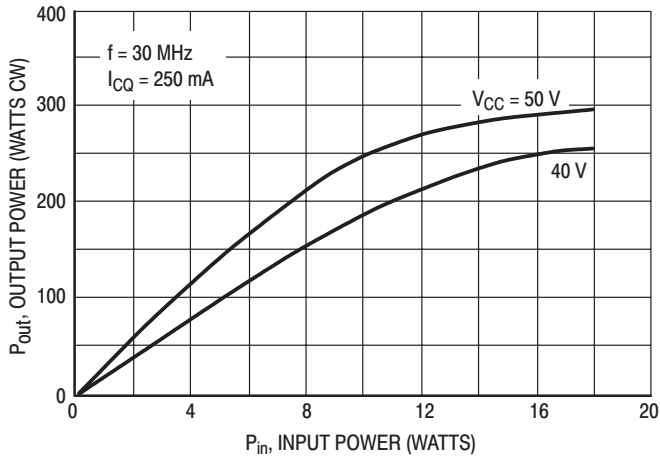

Figure 2. Output Power versus Input Power

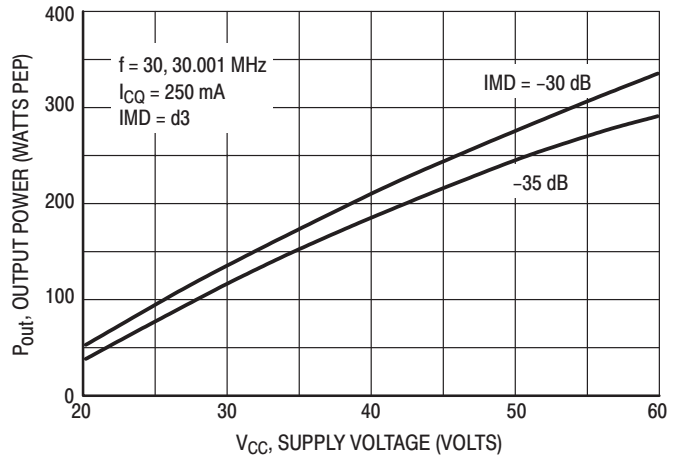

Figure 3. Output Power versus Supply Voltage

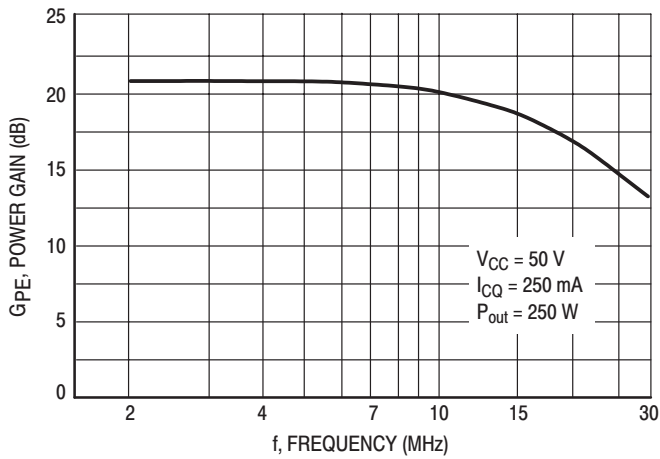

Figure 4. Power Gain versus Frequency

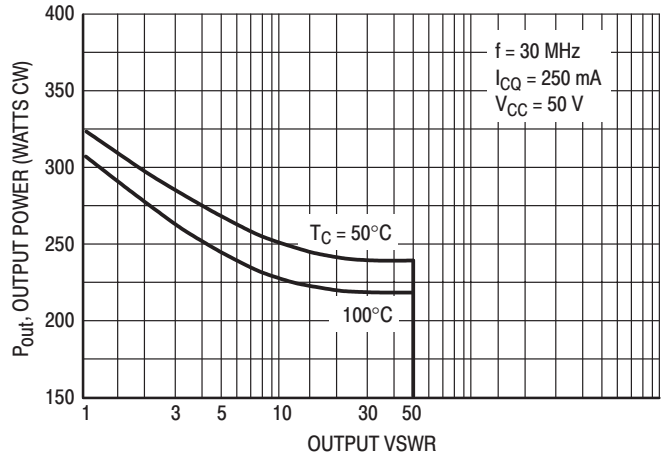

Figure 5. RF SOAR (Class AB) P_{out} versus Output VSWR

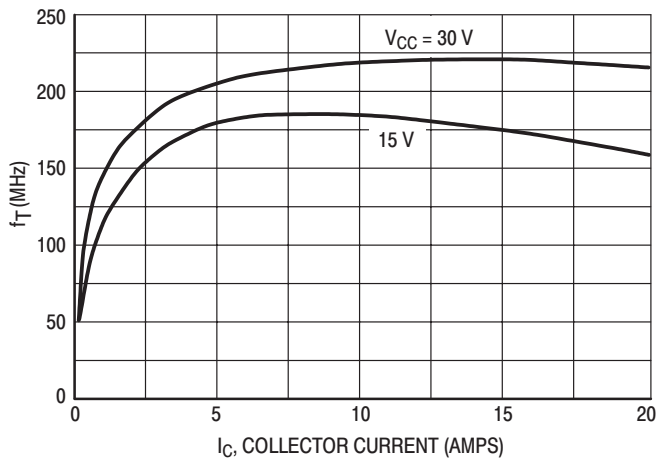

Figure 6. f_T versus Collector Current

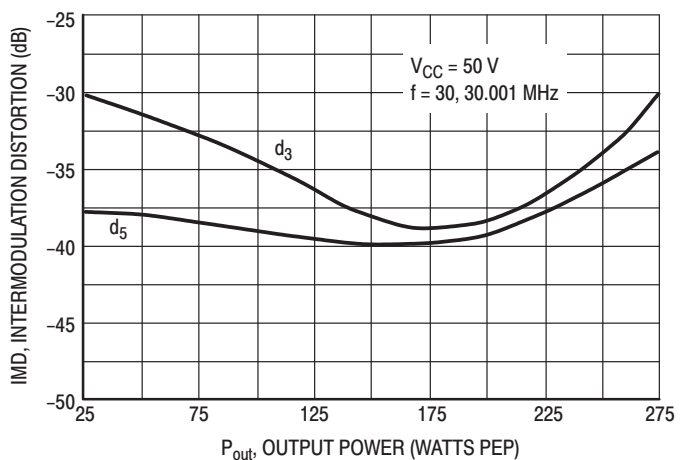

Figure 7. IMD versus P_{out}

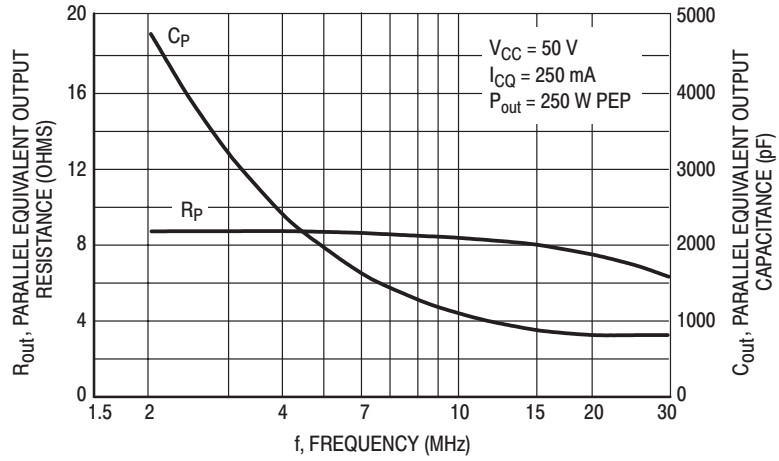
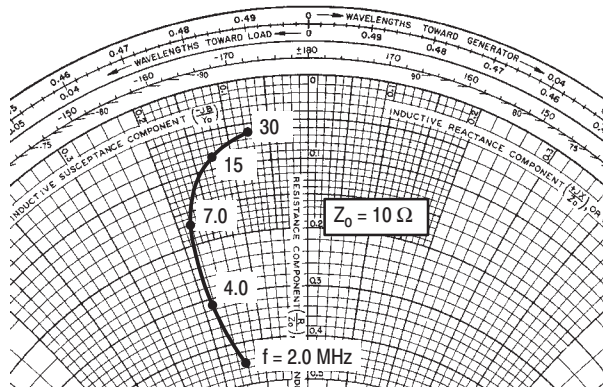

Figure 8. Output Resistance and Capacitance versus Frequency



$V_{CC} = 50 \text{ V}$
 $I_{CQ} = 150 \text{ mA}$
 $P_{out} = 250 \text{ W PEP}$

f MHz	Z_{in} Ohms
2.0	4.50 - j1.40
4.0	3.10 - j1.80
7.0	1.70 - j1.75
15	0.80 - j1.25
30	0.60 - j0.75

Figure 9. Series Equivalent Impedance

PACKAGE DIMENSIONS

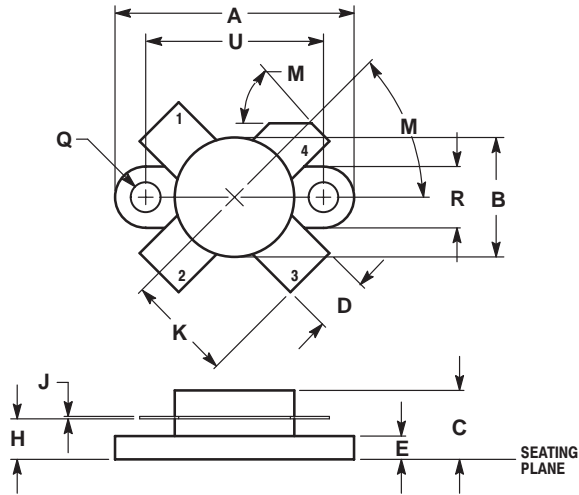

NOTES:

1. DIMENSIONING AND TOLERANCING PER ANSI Y14.5M, 1982.
2. CONTROLLING DIMENSION: INCH.

DIM	INCHES		MILLIMETERS	
	MIN	MAX	MIN	MAX
A	0.960	0.990	24.39	25.14
B	0.465	0.510	11.82	12.95
C	0.229	0.275	5.82	6.98
D	0.216	0.235	5.49	5.96
E	0.084	0.110	2.14	2.79
H	0.144	0.178	3.66	4.52
J	0.003	0.007	0.08	0.17
K	0.435	---	11.05	---
M	45°NOM		45°NOM	
Q	0.115	0.130	2.93	3.30
R	0.246	0.255	6.25	6.47
U	0.720	0.730	18.29	18.54

STYLE 1:

- PIN 1. EMITTER
 2. BASE
 3. EMITTER
 4. COLLECTOR

**CASE 211-11
ISSUE N**

Specifications subject to change without notice.

- **North America:** Tel. (800) 366-2266, Fax (800) 618-8883
- **Asia/Pacific:** Tel.+81-44-844-8296, Fax +81-44-844-8298
- **Europe:** Tel. +44 (1344) 869 595, Fax+44 (1344) 300 020

Visit www.macom.com for additional data sheets and product information.