

The RF Line NPN Silicon High-Frequency Transistor

MRF5811LT1

- Designed for high current, low power amplifiers up to 1.0 GHz.
- Low Noise (2.0 dB @ 500 MHz)
 - Low Intermodulation Distortion
 - High Gain
 - State-of-the-Art Technology
 - Fine Line Geometry
 - Arsenic Emitters
 - Gold Top Metallization
 - Nichrome Thin-Film Ballasting Resistors
 - Excellent Dynamic Range
 - Fully Characterized
 - High Current-Gain Bandwidth Product
 - Available in Tape and Reel by Adding T1 Suffix to Part Number.
T1 Suffix = 3,000 Units per 8 mm, 7 inch Reel.

I_C = 200 mA
LOW NOISE
HIGH-FREQUENCY
TRANSISTOR
NPN SILICON

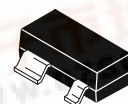

CASE 318A-05, STYLE 1

MAXIMUM RATINGS

Rating	Symbol	Value	Unit
Collector-Emitter Voltage	V _{CEO}	18	Vdc
Collector-Base Voltage	V _{CBO}	36	Vdc
Emitter-Base Voltage	V _{EBO}	2.5	Vdc
Collector Current — Continuous	I _C	200	mAdc
Thermal Resistance θ_{JC} (1)	R θ_{JC}	106	°C/W
Total Device Dissipation @ T _C = 75°C Derate above T _C = 75°C	P _D	0.71 9.4	Watts mW/°C
Storage Junction Temperature Range	T _{stg}	- 55 to +150	°C
Maximum Junction Temperature	T _{Jmax}	150	°C

DEVICE MARKING

MRF5811L = 20

NOTES:

1. Case temperature measured on collector lead immediately adjacent to body of package.

ELECTRICAL CHARACTERISTICS ($T_C = 25^\circ\text{C}$ unless otherwise noted)

Characteristic	Symbol	Min	Typ	Max	Unit
----------------	--------	-----	-----	-----	------

OFF CHARACTERISTICS

Collector–Emitter Breakdown Voltage ($I_C = 5.0\text{ mAdc}$, $I_B = 0$)	$V_{(BR)CEO}$	18	—	—	Vdc
Collector–Base Breakdown Voltage ($I_C = 1.0\text{ mAdc}$, $I_E = 0$)	$V_{(BR)CBO}$	36	—	—	Vdc
Emitter–Base Breakdown Voltage ($I_E = 0.1\text{ mAdc}$, $I_C = 0$)	$V_{(BR)EBO}$	2.5	—	—	Vdc
Emitter Cutoff Current ($V_{EB} = 2.0\text{ Vdc}$, $V_{BE} = 0$)	I_{EBO}	—	—	100	$\mu\text{A dc}$
Collector Cutoff Current ($V_{CB} = 15\text{ Vdc}$, $I_E = 0$)	I_{CBO}	—	—	100	$\mu\text{A dc}$

ON CHARACTERISTICS

DC Current Gain (1) ($I_C = 50\text{ mAdc}$, $V_{CE} = 5.0\text{ Vdc}$)	h_{FE}	50	—	200	—
---	----------	----	---	-----	---

DYNAMIC CHARACTERISTICS

Collector–Base Capacitance ($V_{CB} = 10\text{ Vdc}$, $I_E = 0$, $f = 1.0\text{ MHz}$)	C_{ob}	—	2.0	—	pF
Collector–Base Capacitance ($V_{CB} = 10\text{ Vdc}$, $I_E = 0$, $f = 1.0\text{ MHz}$)	C_{cb}	—	1.2	2.0	pF
Current–Gain Bandwidth Product (2) ($I_C = 75\text{ mAdc}$, $V_{CE} = 10\text{ Vdc}$, $f = 1.0\text{ GHz}$)	f_T	—	5.0	—	GHz

FUNCTIONAL TESTS

Noise Figure (Minimum), Figure 3 ($I_C = 50\text{ mAdc}$, $V_{CE} = 10\text{ Vdc}$, $f = 500\text{ MHz}$)	N_{Fmin}	—	2.0	3.0	dB
Noise Figure (50 Ohm Insertion) ($I_C = 50\text{ mAdc}$, $V_{CE} = 10\text{ Vdc}$, $f = 500\text{ MHz}$)	$N_{F50\Omega}$	—	2.5	—	dB
Power Gain at Optimum Noise Figure, Figure 3 ($I_C = 50\text{ mAdc}$, $V_{CE} = 10\text{ Vdc}$, $f = 500\text{ MHz}$)	G_{NF}	—	18.4	—	dB
Insertion Gain ($I_C = 50\text{ mAdc}$, $V_{CE} = 6.0\text{ Vdc}$, $f = 500\text{ MHz}$)	$ S_{21} ^2$	—	14.2	—	dB
Maximum Unilateral Gain (2) ($I_C = 50\text{ mAdc}$, $V_{CE} = 6.0\text{ Vdc}$, $f = 500\text{ MHz}$)	G_{Umax}	—	18	—	dB

NOTES:

- 300 μs pulse on Tektronix 576 or equivalent.

$$2. G_{Umax} = \frac{|S_{21}|^2}{(1-|S_{11}|^2)(1-|S_{22}|^2)}$$

TYPICAL CHARACTERISTICS

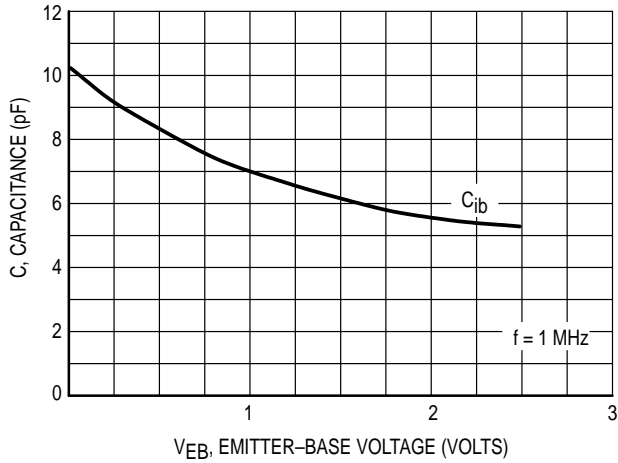

Figure 1. C_{ib} Input Capacitance versus Voltage

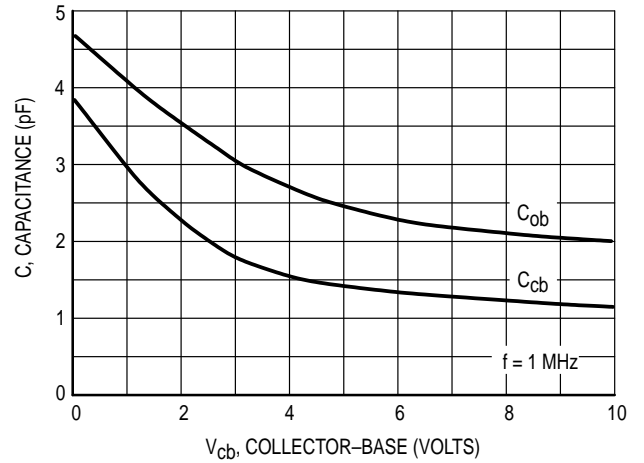

Figure 2. C_{cb} , C_{ob} Collector-Base Capacitance versus Voltage

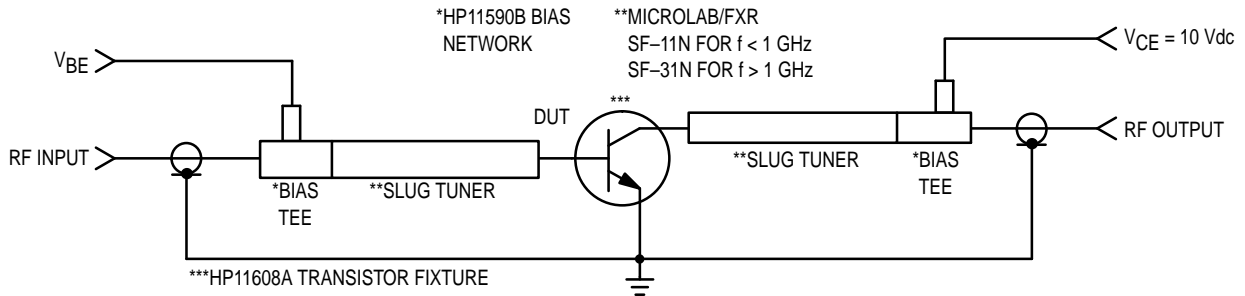

Figure 3. MRF5811L Functional Circuit Schematic

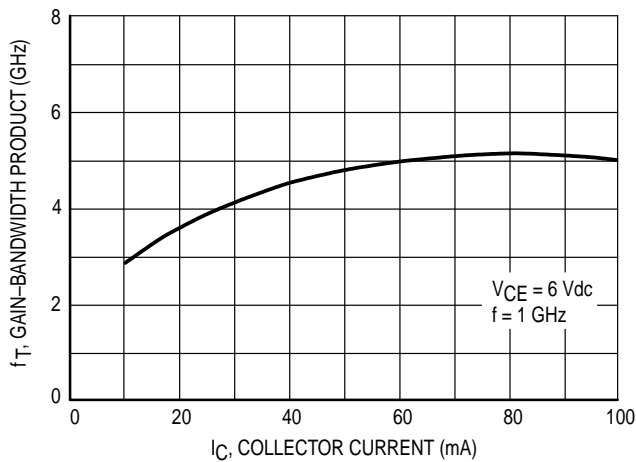

Figure 4. Gain-Bandwidth Product versus Collector Current

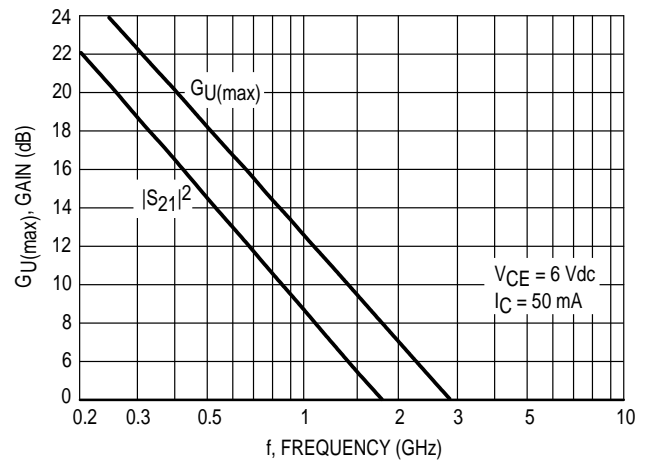

Figure 5. $G_{U(max)}$ Maximum Unilateral Gain, $|S_{21}|^2$ versus Frequency

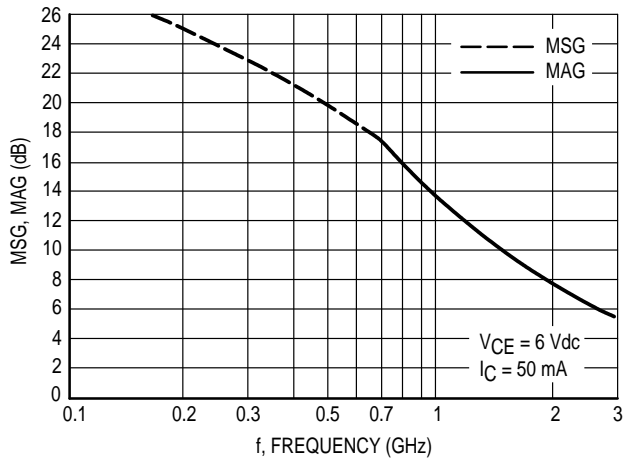

Figure 6. MSG — Maximum Stable Gain, MAG — Maximum Available Gain versus Frequency

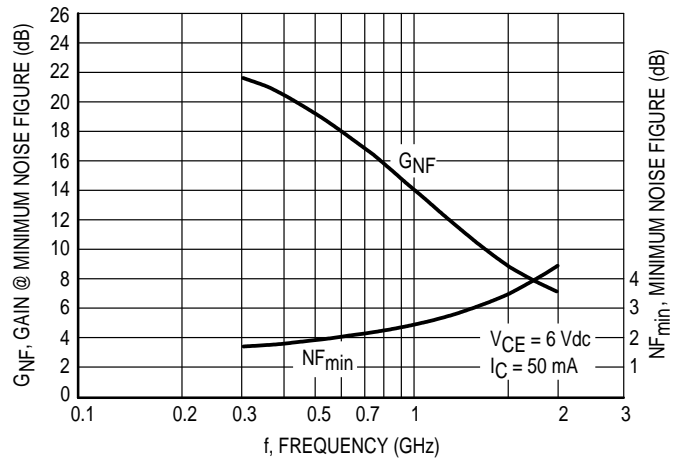

Figure 7. Minimum Noise Figure and Gain @ Minimum Noise Figure versus Frequency

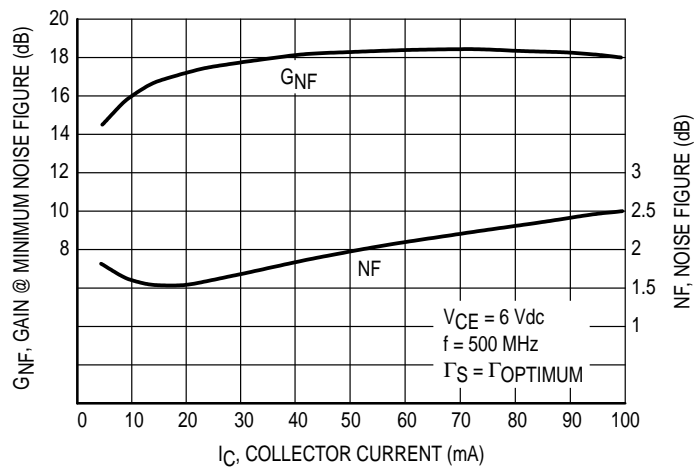

Figure 8. Noise Figure and Gain @ Minimum Noise Figure versus Collector Current

V_{CE} (Vdc)	I_C (mA)	f (MHz)	NFmin (dB)	Gam Opt	< Gam Opt	Rn
6.0	10	500	1.64	0.49	164	3.5
		1000	2.81	0.68	-173	3.5
	50	500	2.0	0.51	177	3.9
		1000	2.85	0.61	-168	4.7

Table 1. Common Emitter Noise Parameters

V _{CE} (Volts)	I _C (mA)	f (GHz)	S ₁₁		S ₂₁		S ₁₂		S ₂₂		
			S ₁₁	∠φ	S ₂₁	∠φ	S ₁₂	∠φ	S ₂₂	∠φ	
3.0	25	0.10	0.734	-132	17.54	115	0.045	37	0.544	-89	
		0.20	0.765	-157	9.66	99	0.051	30	0.395	-120	
		0.30	0.771	-168	6.59	90	0.056	32	0.354	-135	
		0.40	0.773	-174	4.98	84	0.060	34	0.340	-143	
		0.50	0.768	-180	4.01	81	0.065	38	0.319	-150	
		0.60	0.768	176	3.36	76	0.070	41	0.319	-153	
		0.70	0.769	173	2.89	73	0.076	43	0.321	-155	
		0.80	0.771	170	2.55	69	0.081	44	0.325	-157	
		0.90	0.770	167	2.27	65	0.088	46	0.329	-158	
		1.00	0.771	165	2.06	62	0.094	47	0.335	-159	
		1.50	0.773	152	1.41	47	0.127	49	0.367	-163	
		2.00	0.777	140	1.08	33	0.162	48	0.408	-167	
		2.50	0.786	129	0.87	22	0.194	45	0.461	-171	
		3.00	0.793	118	0.75	12	0.229	40	0.498	-177	
		3.50	0.803	108	0.65	4	0.262	35	0.530	177	
		4.00	0.812	100	0.58	-2	0.294	30	0.563	169	
	4.50	0.811	91	0.53	-7	0.328	24	0.587	162		
	5.00	0.816	83	0.50	-11	0.355	18	0.616	154		
	50	50	0.10	0.732	-141	19.19	112	0.039	36	0.542	-105
			0.20	0.764	-163	10.33	97	0.045	34	0.44	-136
			0.30	0.771	-172	7.01	90	0.050	37	0.416	-149
			0.40	0.772	-177	5.29	84	0.056	40	0.408	-156
			0.50	0.768	178	4.26	81	0.062	44	0.392	-162
			0.60	0.768	174	3.57	77	0.069	47	0.392	-165
			0.70	0.769	171	3.08	74	0.076	49	0.393	-167
			0.80	0.770	168	2.71	70	0.083	50	0.395	-169
			0.90	0.769	166	2.42	67	0.090	51	0.396	-170
			1.00	0.769	163	2.19	64	0.098	51	0.399	-172
			1.50	0.769	151	1.51	50	0.135	51	0.414	-176
			2.00	0.771	139	1.17	37	0.171	48	0.434	-180
			2.50	0.778	128	0.96	26	0.204	44	0.467	178
			3.00	0.783	118	0.83	16	0.237	39	0.487	173
			3.50	0.792	108	0.73	7	0.268	33	0.506	168
			4.00	0.802	100	0.66	0	0.297	28	0.53	162
	4.50	0.800	91	0.60	-6	0.328	22	0.546	156		
	5.00	0.808	83	0.56	-12	0.353	16	0.572	149		
75	75	0.10	0.738	-145	19.35	110	0.036	35	0.54	-112	
		0.20	0.769	-165	10.31	96	0.042	35	0.458	-142	
		0.30	0.774	-173	6.98	89	0.048	39	0.44	-153	
		0.40	0.776	-178	5.26	84	0.054	43	0.434	-160	
		0.50	0.772	177	4.24	81	0.061	47	0.42	-166	
		0.60	0.772	173	3.55	77	0.068	49	0.42	-169	
		0.70	0.773	170	3.06	74	0.076	51	0.421	-171	
		0.80	0.773	168	2.69	71	0.084	52	0.422	-172	
		0.90	0.772	165	2.41	67	0.091	53	0.423	-174	
		1.00	0.772	162	2.18	65	0.099	53	0.426	-175	
		1.50	0.771	150	1.50	50	0.138	52	0.436	-180	
		2.00	0.772	139	1.17	38	0.175	48	0.451	176	
		2.50	0.778	128	0.96	27	0.208	44	0.478	174	
		3.00	0.783	117	0.83	17	0.241	38	0.493	169	
		3.50	0.790	108	0.74	8	0.271	33	0.507	165	
		4.00	0.800	99	0.67	1	0.299	27	0.526	158	
4.50	0.798	91	0.62	-5	0.329	21	0.538	153			
5.00	0.806	83	0.57	-11	0.353	15	0.561	147			

Table 2. Common Emitter S-Parameters

V _{CE} (Volts)	I _C (mA)	f (GHz)	S ₁₁		S ₂₁		S ₁₂		S ₂₂		
			S ₁₁	∠φ	S ₂₁	∠φ	S ₁₂	∠φ	S ₂₂	∠φ	
3.0	100	0.10	0.747	-149	18.83	109	0.035	35	0.531	-117	
		0.20	0.775	-167	9.95	95	0.041	35	0.463	-145	
		0.30	0.781	-175	6.72	88	0.047	40	0.448	-156	
		0.40	0.782	-179	5.07	83	0.053	44	0.444	-162	
		0.50	0.779	176	4.08	81	0.061	48	0.431	-168	
		0.60	0.778	173	3.42	77	0.068	50	0.431	-170	
		0.70	0.779	170	2.95	74	0.076	52	0.432	-172	
		0.80	0.779	167	2.60	70	0.084	53	0.434	-174	
		0.90	0.778	164	2.32	67	0.092	53	0.434	-175	
		1.00	0.778	162	2.10	64	0.100	54	0.436	-177	
		1.50	0.776	150	1.45	50	0.139	52	0.445	179	
		2.00	0.777	138	1.13	38	0.177	48	0.46	175	
		2.50	0.782	127	0.93	27	0.209	44	0.485	173	
		3.00	0.786	117	0.81	17	0.243	38	0.498	168	
		3.50	0.794	107	0.72	9	0.273	32	0.51	163	
		4.00	0.802	99	0.65	1	0.301	27	0.528	157	
		4.50	0.800	91	0.60	-5	0.330	21	0.539	152	
5.00	0.807	83	0.56	-11	0.354	15	0.56	145			
6.0	25	0.10	0.715	-122	19.96	119	0.039	40	0.562	-72	
		0.20	0.742	-151	11.31	101	0.046	33	0.364	-98	
		0.30	0.748	-164	7.76	92	0.050	33	0.298	-112	
		0.40	0.750	-171	5.89	86	0.054	36	0.271	-120	
		0.50	0.743	-177	4.73	82	0.058	39	0.24	-127	
		0.60	0.744	179	3.97	78	0.063	42	0.237	-131	
		0.70	0.746	175	3.42	74	0.068	44	0.239	-134	
		0.80	0.748	172	3.00	70	0.074	46	0.243	-135	
		0.90	0.747	169	2.68	66	0.079	47	0.248	-137	
		1.00	0.748	166	2.42	63	0.085	49	0.255	-139	
		1.50	0.753	153	1.64	47	0.115	52	0.3	-144	
		2.00	0.760	141	1.25	33	0.148	51	0.352	-150	
		2.50	0.772	130	1.00	21	0.180	49	0.417	-155	
		3.00	0.783	119	0.84	11	0.215	44	0.464	-163	
		3.50	0.795	109	0.72	2	0.249	40	0.505	-170	
	4.00	0.807	101	0.63	-5	0.283	34	0.545	-179		
	4.50	0.808	92	0.56	-10	0.319	28	0.576	173		
	5.00	0.815	84	0.51	-14	0.349	22	0.609	164		
		50	0.10	0.706	-131	22.47	116	0.034	40	0.527	-86
			0.20	0.734	-157	12.38	99	0.041	36	0.37	-117
			0.30	0.740	-168	8.44	91	0.046	38	0.325	-132
			0.40	0.742	-174	6.38	86	0.051	42	0.308	-140
	0.50		0.736	-179	5.13	82	0.057	46	0.283	-147	
	0.60		0.737	177	4.30	78	0.063	48	0.281	-151	
	0.70		0.738	173	3.70	74	0.069	50	0.282	-154	
	0.80	0.740	170	3.26	71	0.075	51	0.285	-155		
	0.90	0.739	168	2.90	68	0.082	52	0.287	-157		
	1.00	0.740	165	2.63	65	0.089	53	0.291	-158		
	1.50	0.742	152	1.79	50	0.123	53	0.315	-162		
	2.00	0.748	141	1.37	36	0.158	50	0.348	-165		
	2.50	0.758	129	1.11	25	0.189	47	0.395	-168		
	3.00	0.768	119	0.94	14	0.222	42	0.427	-173		
	3.50	0.780	109	0.81	5	0.253	37	0.458	-178		
	4.00	0.793	101	0.72	-3	0.283	32	0.491	175		
	4.50	0.795	92	0.65	-9	0.316	26	0.518	169		
	5.00	0.805	84	0.58	-15	0.343	20	0.552	161		

Table 2. Common Emitter S-Parameters (continued)

V _{CE} (Volts)	I _C (mA)	f (GHz)	S ₁₁		S ₂₁		S ₁₂		S ₂₂		
			S ₁₁	∠φ	S ₂₁	∠φ	S ₁₂	∠φ	S ₂₂	∠φ	
6.0	75	0.10	0.710	-135	22.99	114	0.033	39	0.505	-93	
		0.20	0.735	-159	12.49	98	0.039	37	0.367	-123	
		0.30	0.741	-169	8.49	90	0.044	40	0.33	-137	
		0.40	0.742	-175	6.42	85	0.050	44	0.317	-145	
		0.50	0.737	180	5.16	82	0.056	48	0.295	-153	
		0.60	0.737	176	4.32	78	0.062	50	0.294	-156	
		0.70	0.739	173	3.72	74	0.069	52	0.295	-158	
		0.80	0.740	170	3.27	71	0.076	53	0.297	-160	
		0.90	0.739	167	2.92	68	0.083	54	0.298	-161	
		1.00	0.740	164	2.64	65	0.090	54	0.302	-162	
		1.50	0.742	152	1.80	50	0.125	53	0.322	-166	
		2.00	0.747	140	1.38	37	0.160	50	0.349	-169	
		2.50	0.757	129	1.12	25	0.191	47	0.392	-171	
		3.00	0.766	119	0.95	15	0.224	42	0.42	-176	
		3.50	0.778	109	0.82	5	0.254	36	0.448	180	
		4.00	0.791	100	0.73	-3	0.284	31	0.479	173	
		4.50	0.793	92	0.66	-9	0.315	26	0.504	167	
	5.00	0.803	84	0.60	-15	0.342	20	0.536	160		
		100	0.10	0.718	-138	22.70	112	0.032	38	0.481	-96
			0.20	0.740	-161	12.22	97	0.038	37	0.354	-126
			0.30	0.745	-170	8.28	90	0.043	41	0.321	-140
			0.40	0.746	-176	6.25	84	0.049	45	0.309	-147
			0.50	0.741	179	5.03	81	0.055	49	0.29	-154
			0.60	0.741	175	4.21	77	0.062	51	0.289	-157
			0.70	0.743	172	3.62	74	0.069	53	0.29	-159
			0.80	0.744	169	3.19	70	0.076	54	0.293	-161
			0.90	0.743	166	2.84	67	0.083	54	0.294	-162
			1.00	0.744	164	2.57	64	0.090	55	0.298	-163
			1.50	0.745	151	1.75	49	0.126	54	0.318	-166
			2.00	0.750	140	1.35	36	0.160	51	0.347	-169
			2.50	0.760	129	1.09	25	0.192	47	0.39	-171
			3.00	0.769	118	0.93	14	0.224	42	0.418	-175
			3.50	0.781	109	0.80	5	0.255	37	0.447	180
			4.00	0.793	100	0.71	-3	0.284	31	0.478	173
	4.50		0.794	91	0.64	-9	0.316	26	0.502	167	
	5.00	0.804	84	0.58	-15	0.342	20	0.534	160		

Table 2. Common Emitter S-Parameters (continued)

PACKAGE DIMENSIONS

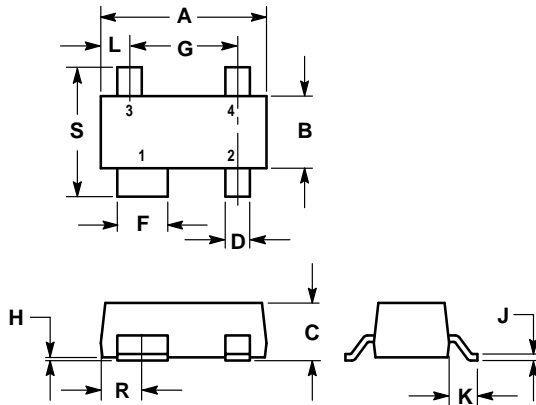

- NOTES:
 3. DIMENSIONING AND TOLERANCING PER ANSI Y14.5M, 1982.
 4. CONTROLLING DIMENSION: MILLIMETER.

DIM	MILLIMETERS		INCHES	
	MIN	MAX	MIN	MAX
A	2.80	3.04	0.110	0.120
B	1.20	1.39	0.047	0.055
C	0.84	1.14	0.033	0.045
D	0.39	0.50	0.015	0.020
F	0.79	0.93	0.031	0.037
G	1.78	2.03	0.070	0.080
H	0.013	0.10	0.0005	0.004
J	0.08	0.15	0.003	0.006
K	0.46	0.60	0.018	0.024
L	0.445	0.60	0.0175	0.024
R	0.72	0.83	0.028	0.033
S	2.11	2.48	0.083	0.098

- STYLE 1:
 PIN 1. COLLECTOR
 2. EMITTER
 3. EMITTER
 4. BASE

CASE 318A-05 ISSUE J

Motorola reserves the right to make changes without further notice to any products herein. Motorola makes no warranty, representation or guarantee regarding the suitability of its products for any particular purpose, nor does Motorola assume any liability arising out of the application or use of any product or circuit, and specifically disclaims any and all liability, including without limitation consequential or incidental damages. "Typical" parameters can and do vary in different applications. All operating parameters, including "Typicals" must be validated for each customer application by customer's technical experts. Motorola does not convey any license under its patent rights nor the rights of others. Motorola products are not designed, intended, or authorized for use as components in systems intended for surgical implant into the body, or other applications intended to support or sustain life, or for any other application in which the failure of the Motorola product could create a situation where personal injury or death may occur. Should Buyer purchase or use Motorola products for any such unintended or unauthorized application, Buyer shall indemnify and hold Motorola and its officers, employees, subsidiaries, affiliates, and distributors harmless against all claims, costs, damages, and expenses, and reasonable attorney fees arising out of, directly or indirectly, any claim of personal injury or death associated with such unintended or unauthorized use, even if such claim alleges that Motorola was negligent regarding the design or manufacture of the part. Motorola and are registered trademarks of Motorola, Inc. Motorola, Inc. is an Equal Opportunity/Affirmative Action Employer.

How to reach us:

USA / EUROPE: Motorola Literature Distribution;
 P.O. Box 20912; Phoenix, Arizona 85036. 1-800-441-2447

JAPAN: Nippon Motorola Ltd.; Tatsumi-SPD-JLDC, Toshikatsu Otsuki,
 6F Seibu-Butsuryu-Center, 3-14-2 Tatsumi Koto-Ku, Tokyo 135, Japan. 03-3521-8315

MFAX: RMFAX0@email.sps.mot.com - TOUCHTONE (602) 244-6609
INTERNET: <http://Design-NET.com>

HONG KONG: Motorola Semiconductors H.K. Ltd.; 8B Tai Ping Industrial Park,
 51 Ting Kok Road, Tai Po, N.T., Hong Kong. 852-26629298