

# International IR Rectifier

PD - 94038A

## HEXFET® POWER MOSFET SURFACE MOUNT (SMD-0.5)

## IRF5NJ9540 100V, P-CHANNEL

### Product Summary

Part Number	BVDSS	RDS(on)	Id
IRF5NJ9540	-100V	0.117Ω	-18A



Fifth Generation HEXFET® power MOSFETs from International Rectifier utilize advanced processing techniques to achieve the lowest possible on-resistance per silicon unit area. This benefit, combined with the fast switching speed and ruggedized device design that HEXFET power MOSFETs are well known for, provides the designer with an extremely efficient device for use in a wide variety of applications.

These devices are well-suited for applications such as switching power supplies, motor controls, inverters, choppers, audio amplifiers and high-energy pulse circuits.

### Features:

- Low RDS(on)
- Avalanche Energy Ratings
- Dynamic dv/dt Rating
- Simple Drive Requirements
- Ease of Paralleling
- Hermetically Sealed
- Surface Mount
- Light Weight

### Absolute Maximum Ratings

	Parameter		Units
Id @ VGS = -10V, TC = 25°C	Continuous Drain Current	-18	A
Id @ VGS = -10V, TC = 100°C	Continuous Drain Current	-11	
IDM	Pulsed Drain Current ①	-72	
Pd @ TC = 25°C	Max. Power Dissipation	75	W
	Linear Derating Factor	0.6	W/°C
VGS	Gate-to-Source Voltage	±20	V
EAS	Single Pulse Avalanche Energy ②	260	mJ
IAR	Avalanche Current ①	-11	A
EAR	Repetitive Avalanche Energy ①	7.5	mJ
dv/dt	Peak Diode Recovery dv/dt ③	4.1	V/ns
TJ	Operating Junction	-55 to 150	°C
TSTG	Storage Temperature Range		
	Package Mounting Surface Temperature	300 (for 5 s)	
	Weight	1.0 (Typical)	g

For footnotes refer to the last page

www.irf.com

1

7/13/01



**Electrical Characteristics @ T<sub>j</sub> = 25°C (Unless Otherwise Specified)**

	Parameter	Min	Typ	Max	Units	Test Conditions
B <sub>V</sub> DSS	Drain-to-Source Breakdown Voltage	-100	—	—	V	V <sub>GS</sub> = 0V, I <sub>D</sub> = -250μA
ΔB <sub>V</sub> DSS/ΔT <sub>J</sub>	Temperature Coefficient of Breakdown Voltage	—	-0.104	—	V/°C	Reference to 25°C, I <sub>D</sub> = -1.0mA
R <sub>DS(on)</sub>	Static Drain-to-Source On-State Resistance	—	—	0.117	Ω	V <sub>GS</sub> = 10V, I <sub>D</sub> = -11A ④
V <sub>GS(th)</sub>	Gate Threshold Voltage	-2.0	—	-4.0	V	V <sub>DS</sub> = V <sub>GS</sub> , I <sub>D</sub> = -250μA
g <sub>fs</sub>	Forward Transconductance	5.0	—	—	S (r)	V <sub>DS</sub> = -50V, I <sub>DS</sub> = -11A ④
I <sub>DSS</sub>	Zero Gate Voltage Drain Current	—	—	-25	μA	V <sub>DS</sub> = -100V, V <sub>GS</sub> = 0V
		—	—	-250		V <sub>DS</sub> = -80V, V <sub>GS</sub> = 0V, T <sub>J</sub> = 125°C
I <sub>GSS</sub>	Gate-to-Source Leakage Forward	—	—	-100	nA	V <sub>GS</sub> = -20V
I <sub>GSS</sub>	Gate-to-Source Leakage Reverse	—	—	100		V <sub>GS</sub> = 20V
Q <sub>g</sub>	Total Gate Charge	—	—	109	nC	V <sub>GS</sub> = -10V, I <sub>D</sub> = -11A
Q <sub>gs</sub>	Gate-to-Source Charge	—	—	19		V <sub>DS</sub> = -80V
Q <sub>gd</sub>	Gate-to-Drain ('Miller') Charge	—	—	53		
t <sub>d(on)</sub>	Turn-On Delay Time	—	—	29	ns	V <sub>DD</sub> = -50V, I <sub>D</sub> = -11A, V <sub>GS</sub> = -10V, R <sub>G</sub> = 5.1Ω
t <sub>r</sub>	Rise Time	—	—	135		
t <sub>d(off)</sub>	Turn-Off Delay Time	—	—	87		
t <sub>f</sub>	Fall Time	—	—	84		
LS + LD	Total Inductance	—	4.0	—	nH	Measured from the center of drain pad to center of source pad
C <sub>iss</sub>	Input Capacitance	—	1340	—	pF	V <sub>GS</sub> = 0V, V <sub>DS</sub> = -25V f = 1.0MHz
C <sub>oss</sub>	Output Capacitance	—	428	—		
C <sub>rss</sub>	Reverse Transfer Capacitance	—	246	—		

**Source-Drain Diode Ratings and Characteristics**

	Parameter	Min	Typ	Max	Units	Test Conditions
I <sub>S</sub>	Continuous Source Current (Body Diode)	—	—	-18	A	T <sub>j</sub> = 25°C, I <sub>S</sub> = -11A, V <sub>GS</sub> = 0V ④
I <sub>SM</sub>	Pulse Source Current (Body Diode) ①	—	—	-72		
V <sub>SD</sub>	Diode Forward Voltage	—	—	-1.6	V	T <sub>j</sub> = 25°C, I <sub>F</sub> = -11A, di/dt ≤ -100A/μs
t <sub>rr</sub>	Reverse Recovery Time	—	—	220	ns	V <sub>DD</sub> ≤ -50V ④
Q <sub>RR</sub>	Reverse Recovery Charge	—	—	1200	nC	
t <sub>on</sub>	Forward Turn-On Time	Intrinsic turn-on time is negligible. Turn-on speed is substantially controlled by LS + LD.				

**Thermal Resistance**

	Parameter	Min	Typ	Max	Units	Test Conditions
R <sub>thJC</sub>	Junction-to-Case	—	—	1.67	°C/W	

Note: Corresponding Spice and Saber models are available on the G&S Website.

For footnotes refer to the last page

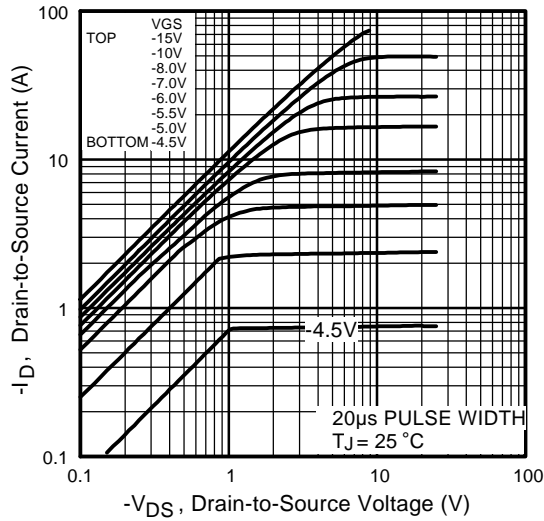

**Fig 1.** Typical Output Characteristics

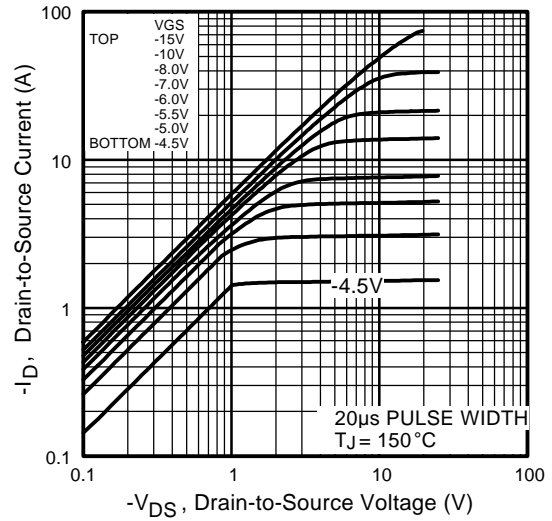

**Fig 2.** Typical Output Characteristics

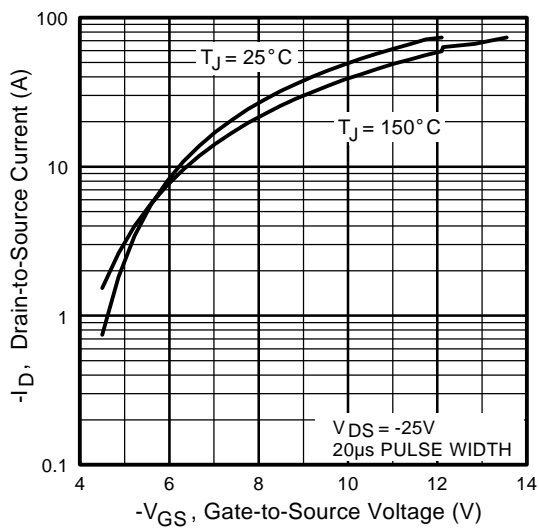

**Fig 3.** Typical Transfer Characteristics

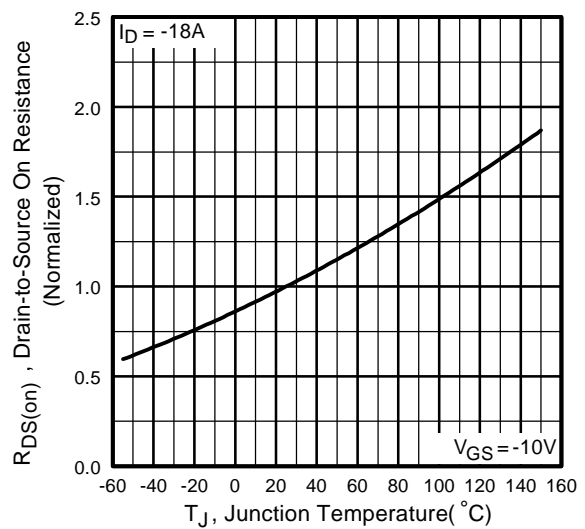

**Fig 4.** Normalized On-Resistance Vs. Temperature

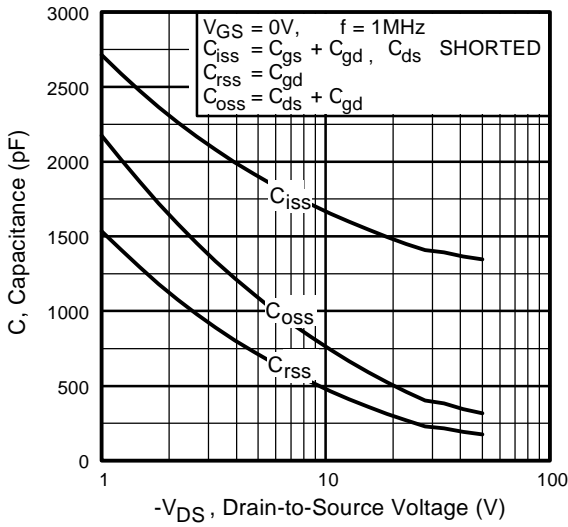

**Fig 5.** Typical Capacitance Vs. Drain-to-Source Voltage

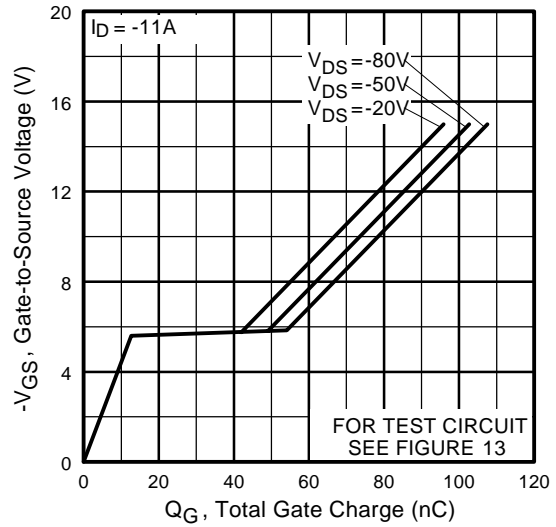

**Fig 6.** Typical Gate Charge Vs. Gate-to-Source Voltage

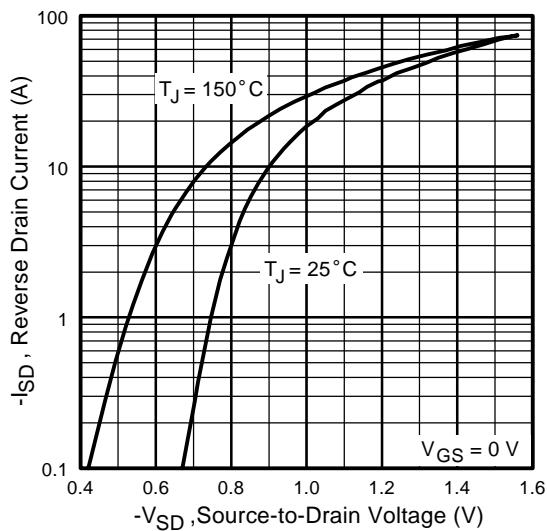

**Fig 7.** Typical Source-Drain Diode Forward Voltage

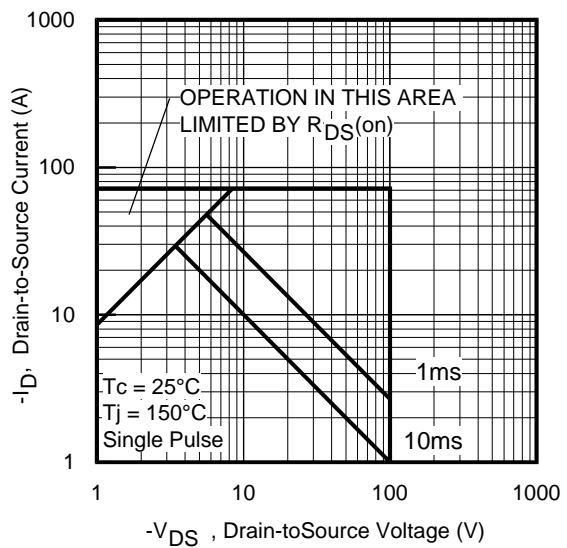

**Fig 8.** Maximum Safe Operating Area

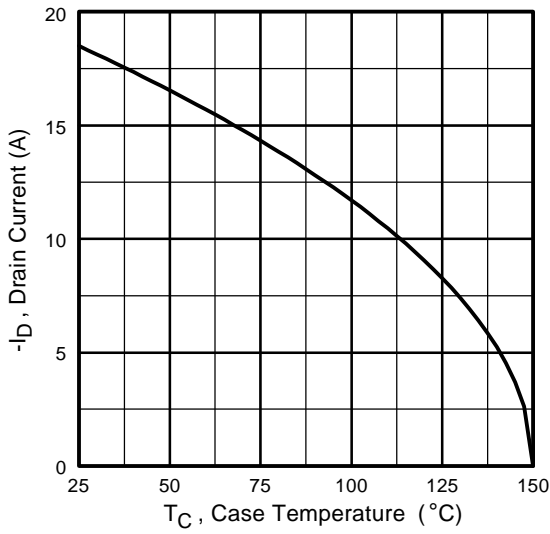

**Fig 9.** Maximum Drain Current Vs. Case Temperature

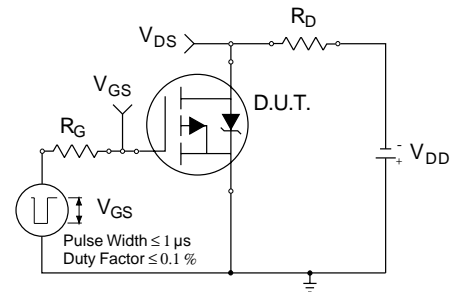

**Fig 10a.** Switching Time Test Circuit

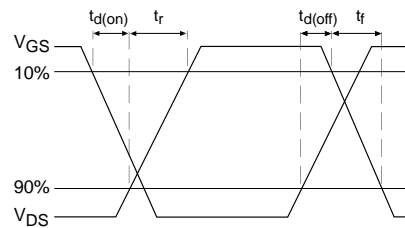

**Fig 10b.** Switching Time Waveforms

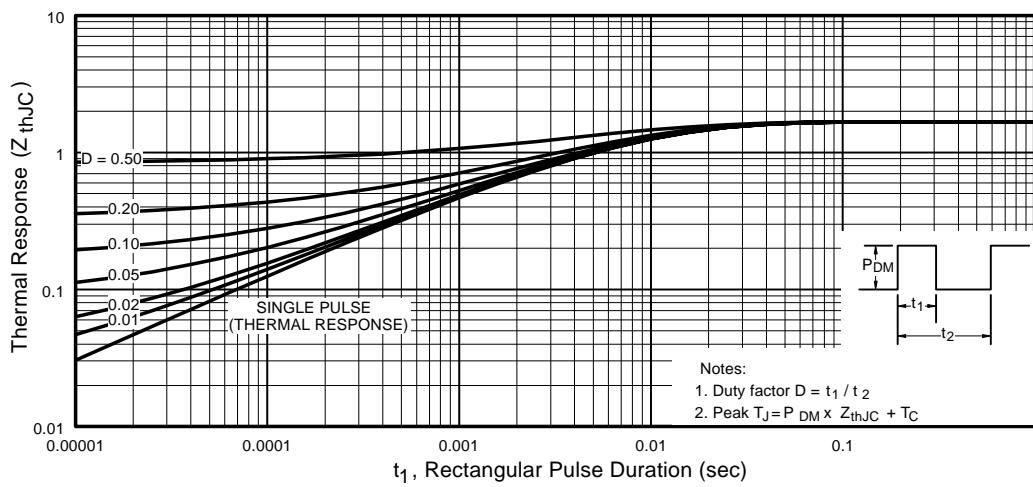

**Fig 11.** Maximum Effective Transient Thermal Impedance, Junction-to-Case

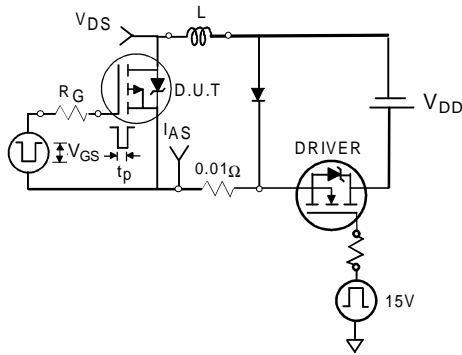

**Fig 12a.** Unclamped Inductive Test Circuit

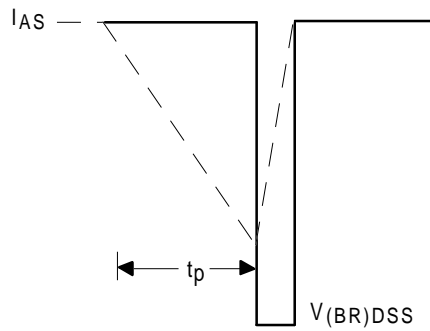

**Fig 12b.** Unclamped Inductive Waveforms

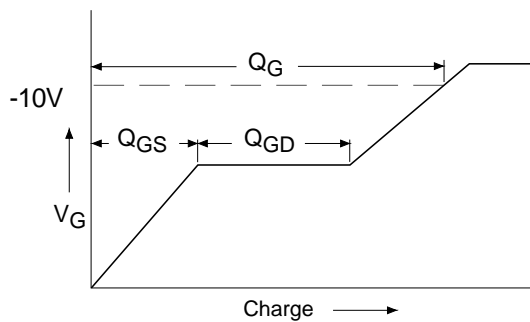

**Fig 13a.** Basic Gate Charge Waveform

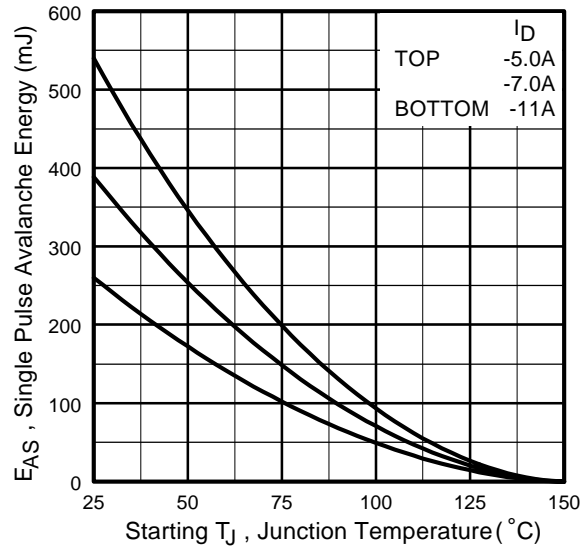

**Fig 12c.** Maximum Avalanche Energy Vs. Drain Current

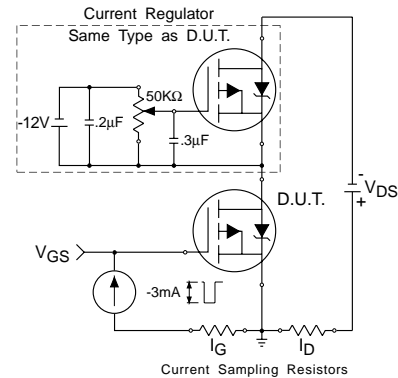
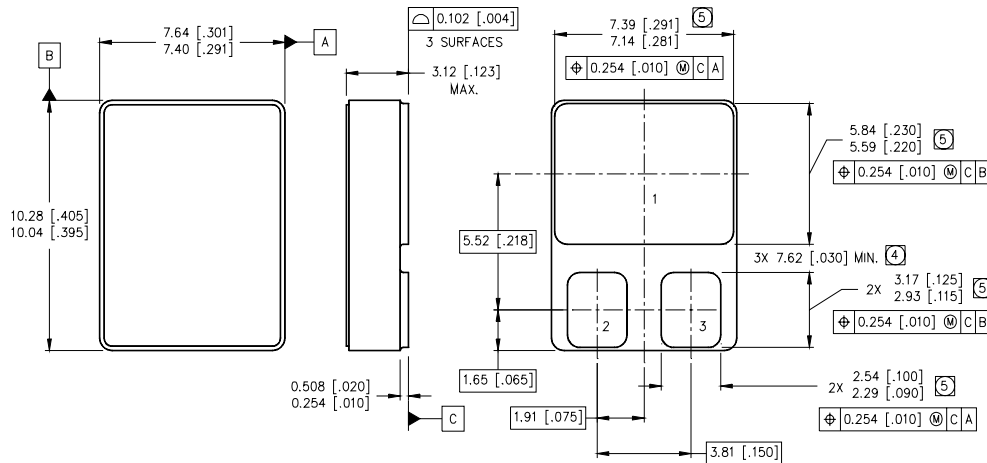

**Fig 13b.** Gate Charge Test Circuit

**Footnotes:**

- ① Repetitive Rating; Pulse width limited by maximum junction temperature.
- ② VDD = -25 V, Starting T<sub>J</sub> = 25°C, L= 4.3mH  
Peak I<sub>AS</sub> = -11A, V<sub>GS</sub> = -10 V, R<sub>G</sub>= 25Ω
- ③ I<sub>SD</sub> ≤ -11A, di/dt ≤ -360 A/μs,  
V<sub>DD</sub> ≤ -100V, T<sub>J</sub> ≤ 150°C
- ④ Pulse width ≤ 300 μs; Duty Cycle ≤ 2%

**Case Outline and Dimensions — SMD-0.5**



**NOTES:**

1. DIMENSIONING & TOLERANCING PER ASME Y14.5M-1994.
2. CONTROLLING DIMENSION: INCH.
3. DIMENSIONS ARE SHOWN IN MILLIMETERS [INCHES].
- ④ DIMENSION INCLUDES METALLIZATION FLASH.
- ⑤ DIMENSION DOES NOT INCLUDE METALLIZATION FLASH.

**PAD ASSIGNMENTS**

- 1 = DRAIN
- 2 = GATE
- 3 = SOURCE