

International Rectifier

PRELIMINARY

IRF7413A

HEXFET® Power MOSFET

- Generation V Technology
- Ultra Low On-Resistance
- N-Channel Mosfet
- Surface Mount
- Available in Tape & Reel
- Dynamic dv/dt Rating
- Fast Switching

Description

Fifth Generation HEXFETs from International Rectifier utilize advanced processing techniques to achieve extremely low on-resistance per silicon area. This benefit, combined with the fast switching speed and ruggedized device design that HEXFET Power MOSFETs are well known for, provides the designer with an extremely efficient and reliable device for use in a wide variety of applications.

The SO-8 has been modified through a customized leadframe for enhanced thermal characteristics and multiple-die capability making it ideal in a variety of power applications. With these improvements, multiple devices can be used in an application with dramatically reduced board space. The package is designed for vapor phase, infra red, or wave soldering techniques. Power dissipation of greater than 0.8W is possible in a typical PCB mount application.

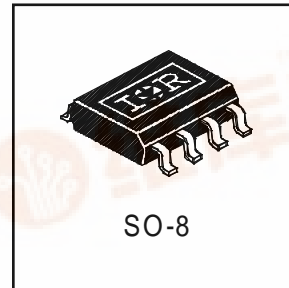
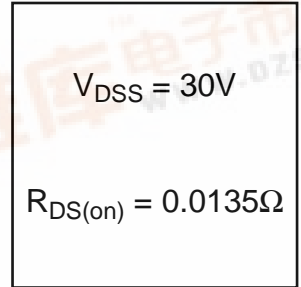
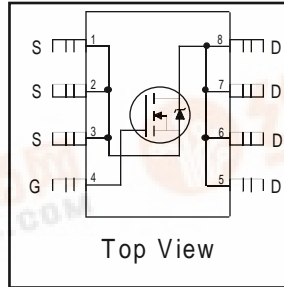

Absolute Maximum Ratings

	Parameter	Max.	Units
$I_D @ T_A = 25^\circ C$	Continuous Drain Current, $V_{GS} @ 10V$	12	A
$I_D @ T_A = 70^\circ C$	Continuous Drain Current, $V_{GS} @ 10V$	8.4	
I_{DM}	Pulsed Drain Current ①	58	
$P_D @ T_A = 25^\circ C$	Power Dissipation	2.5	W
	Linear Derating Factor	0.02	mW/°C
V_{GS}	Gate-to-Source Voltage	± 20	V
E_{AS}	Single Pulse Avalanche Energy②	260	mJ
dv/dt	Peak Diode Recovery dv/dt ③	5.0	V/ns
T_J, T_{STG}	Junction and Storage Temperature Range	-55 to + 150	°C

Thermal Resistance Ratings

	Parameter	Typ.	Max.	Units
$R_{\theta JA}$	Maximum Junction-to-Ambient④	—	50	°C/W



IRF7413A

International
IR Rectifier

Electrical Characteristics @ $T_J = 25^\circ\text{C}$ (unless otherwise specified)

	Parameter	Min.	Typ.	Max.	Units	Conditions
$V_{(BR)DSS}$	Drain-to-Source Breakdown Voltage	30	—	—	V	$V_{GS} = 0V, I_D = 250\mu A$
$\Delta V_{(BR)DSS}/\Delta T_J$	Breakdown Voltage Temp. Coefficient	—	0.034	—	V/°C	Reference to $25^\circ\text{C}, I_D = 1\text{mA}$ ⑤
$R_{DS(on)}$	Static Drain-to-Source On-Resistance	—	—	0.0135	Ω	$V_{GS} = 10V, I_D = 6.6A$ ④
		—	—	0.020		$V_{GS} = 4.5V, I_D = 3.3A$ ④
$V_{GS(th)}$	Gate Threshold Voltage	1.0	—	—	V	$V_{DS} = V_{GS}, I_D = 250\mu A$
g_{fs}	Forward Transconductance	10	—	—	S	$V_{DS} = 10V, I_D = 3.7A$ ⑤
I_{DSS}	Drain-to-Source Leakage Current	—	—	1.0	μA	$V_{DS} = 24V, V_{GS} = 0V$
		—	—	25		$V_{DS} = 24V, V_{GS} = 0V, T_J = 125^\circ\text{C}$
I_{GSS}	Gate-to-Source Forward Leakage	—	—	-100	nA	$V_{GS} = -20V$
	Gate-to-Source Reverse Leakage	—	—	100		$V_{GS} = 20V$
Q_g	Total Gate Charge	—	52	79	nC	$I_D = 7.3A$
Q_{gs}	Gate-to-Source Charge	—	6.1	9.2		$V_{DS} = 24V$
Q_{gd}	Gate-to-Drain ("Miller") Charge	—	16	23		$V_{GS} = 10V$, See Fig. 6 and 9 ④⑤
$t_{d(on)}$	Turn-On Delay Time	—	8.6	—	ns	$V_{DD} = 15V$
t_r	Rise Time	—	50	—		$I_D = 7.3A$
$t_{d(off)}$	Turn-Off Delay Time	—	52	—		$R_G = 6.2\Omega$
t_f	Fall Time	—	46	—		$R_D = 2.0\Omega$, See Fig. 10 ④⑤
C_{iss}	Input Capacitance	—	1800	—	pF	$V_{GS} = 0V$
C_{oss}	Output Capacitance	—	680	—		$V_{DS} = 25V$
C_{rss}	Reverse Transfer Capacitance	—	240	—		$f = 1.0\text{MHz}$, See Fig. 5 ⑤

Source-Drain Ratings and Characteristics

	Parameter	Min.	Typ.	Max.	Units	Conditions
I_S	Continuous Source Current (Body Diode)	—	—	3.1	A	MOSFET symbol showing the integral reverse p-n junction diode.
I_{SM}	Pulsed Source Current (Body Diode) ①	—	—	58		
V_{SD}	Diode Forward Voltage	—	—	1.0	V	$T_J = 25^\circ\text{C}, I_S = 6.6A, V_{GS} = 0V$ ③
t_{rr}	Reverse Recovery Time	—	74	110	ns	$T_J = 25^\circ\text{C}, I_F = 7.3A$
Q_{rr}	Reverse Recovery Charge	—	200	300	nC	$di/dt = 100A/\mu s$ ③⑤

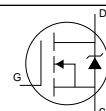

Notes:

① Repetitive rating; pulse width limited by max. junction temperature. (See fig. 11)

② Starting $T_J = 25^\circ\text{C}$, $L = 9.8\text{mH}$
 $R_G = 25\Omega, I_{AS} = 7.3A$. (See Figure 12)

③ $I_{SD} \leq 7.3A, di/dt \leq 100A/\mu s, V_{DD} \leq V_{(BR)DSS}, T_J \leq 150^\circ\text{C}$

④ Pulse width $\leq 300\mu s$; duty cycle $\leq 2\%$.

⑤ Use IRF7413 data and test conditions

⑥ Surface mounted on FR-4 board, $t \leq 10\text{sec}$.

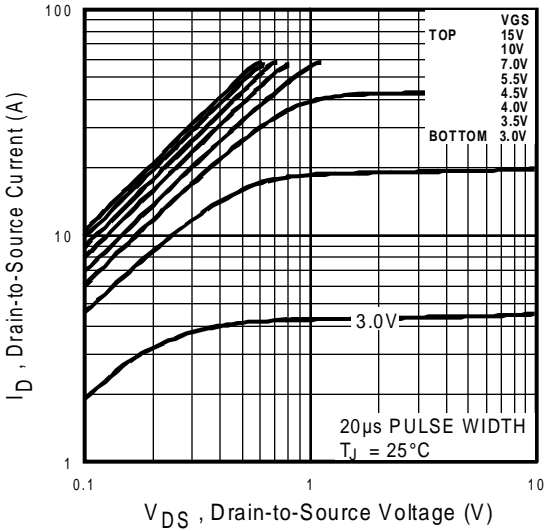

Fig 1. Typical Output Characteristics

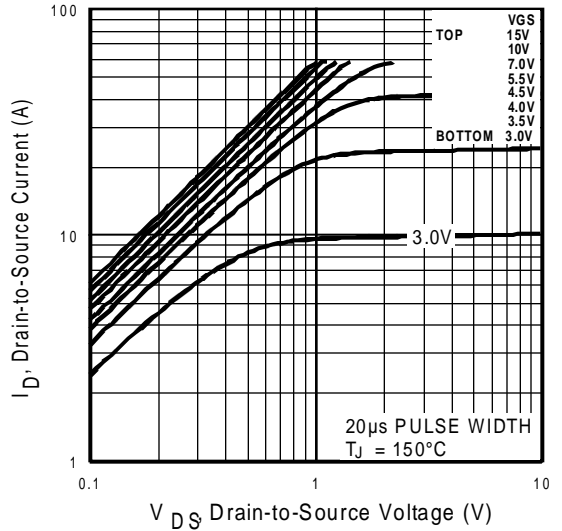

Fig 2. Typical Output Characteristics

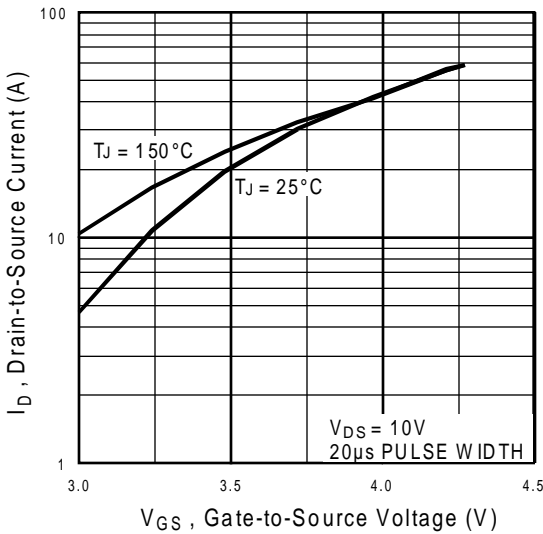

Fig 3. Typical Transfer Characteristics

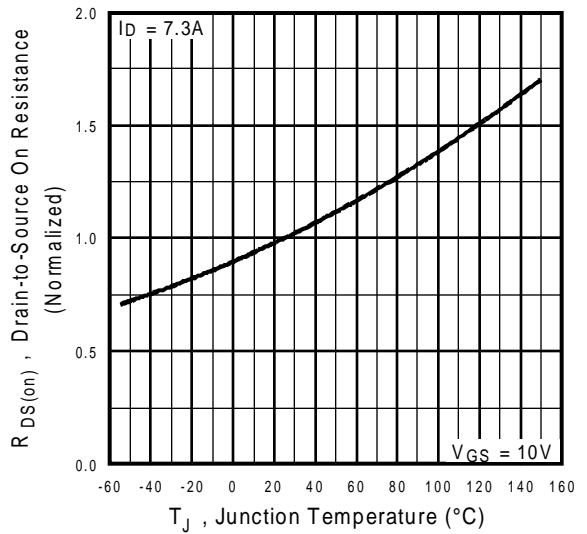

Fig 4. Normalized On-Resistance Vs. Temperature

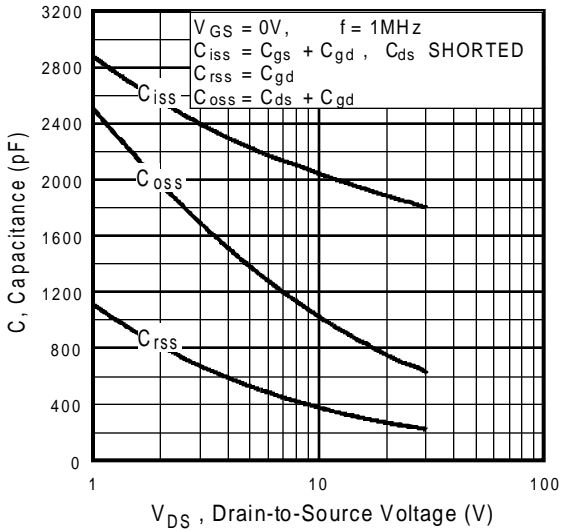

Fig 5. Typical Capacitance Vs. Drain-to-Source Voltage

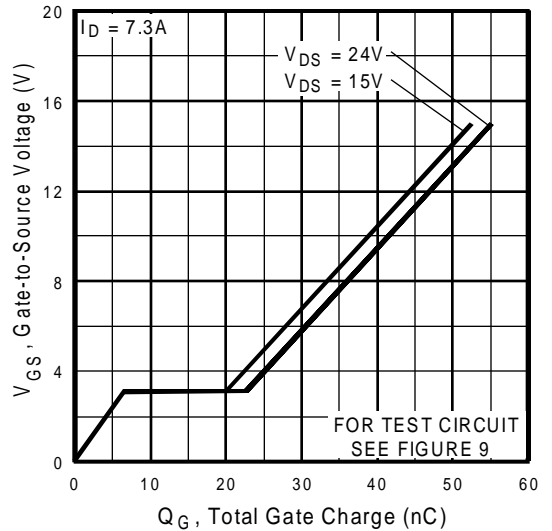

Fig 6. Typical Gate Charge Vs. Gate-to-Source Voltage

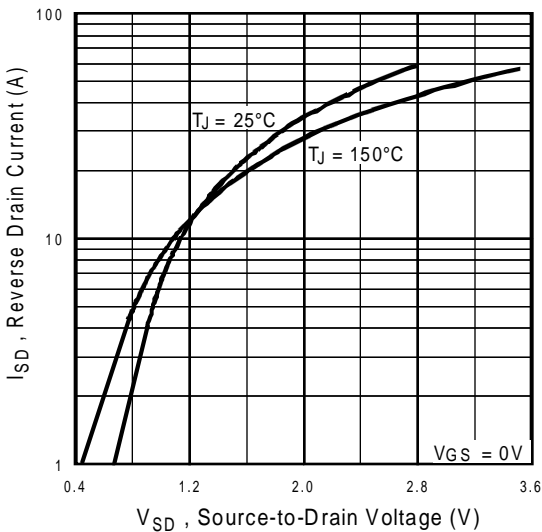

Fig 7. Typical Source-Drain Diode Forward Voltage

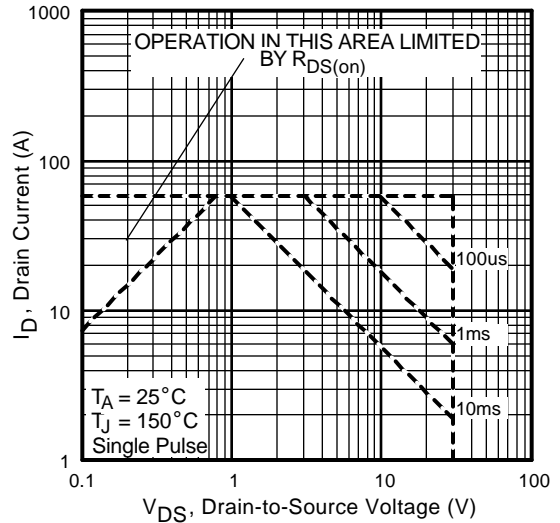

Fig 8. Maximum Safe Operating Area

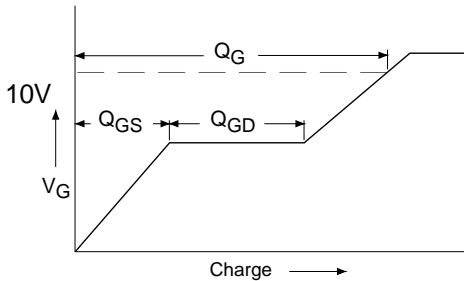

Fig 9a. Basic Gate Charge Waveform

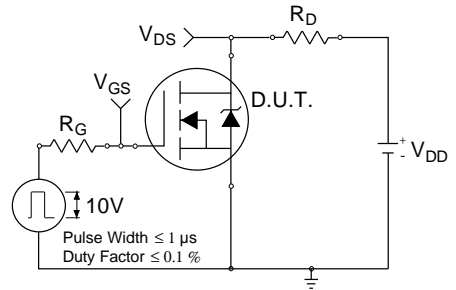

Fig 10a. Switching Time Test Circuit

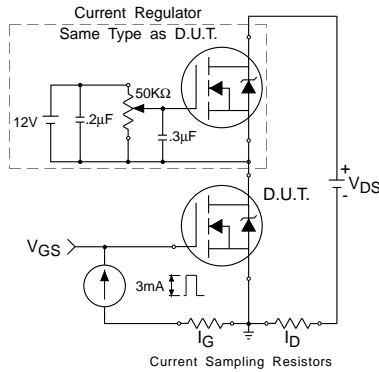

Fig 9b. Gate Charge Test Circuit

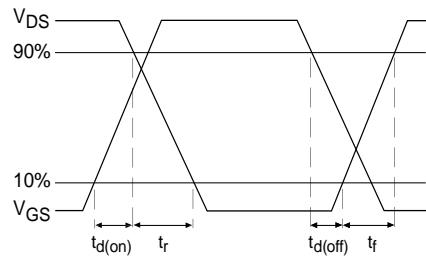

Fig 10b. Switching Time Waveforms

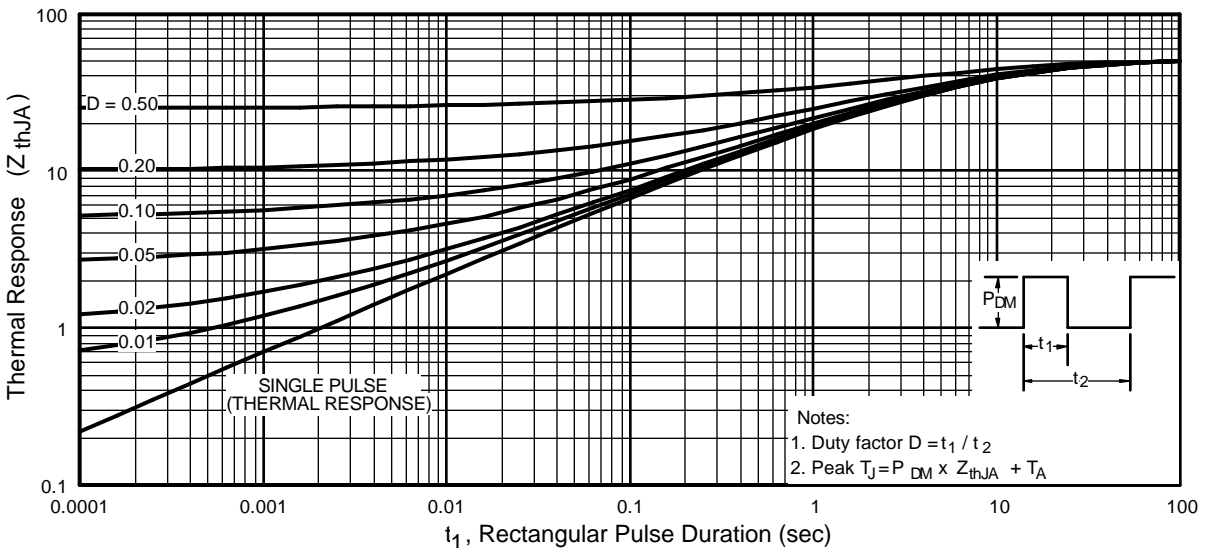

Fig 11. Maximum Effective Transient Thermal Impedance, Junction-to-Ambient

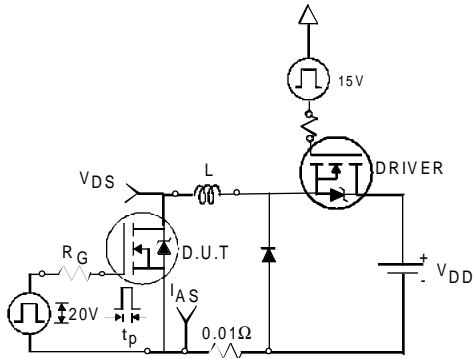

Fig 12a. Unclamped Inductive Test Circuit

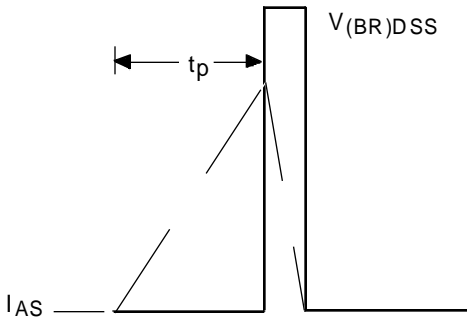

Fig 12b. Unclamped Inductive Waveforms

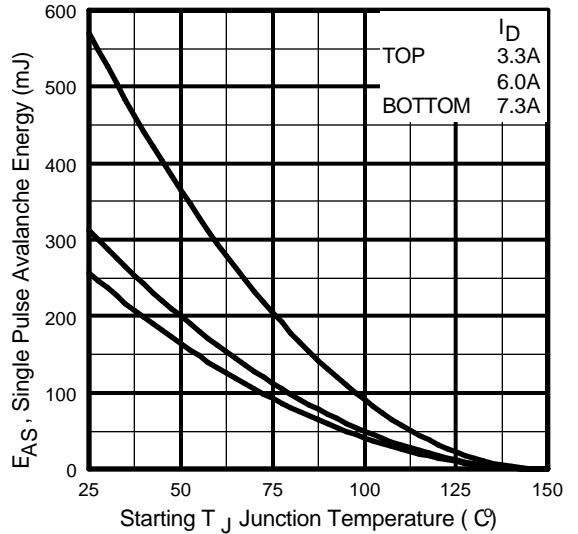
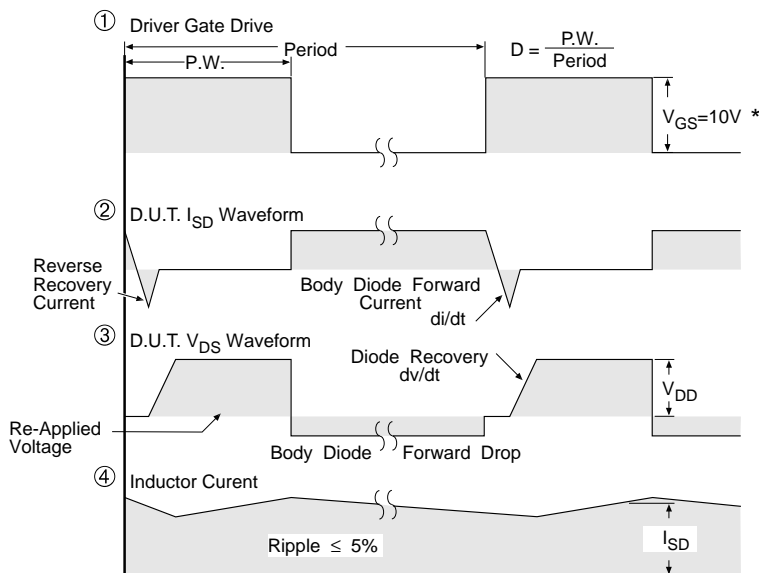
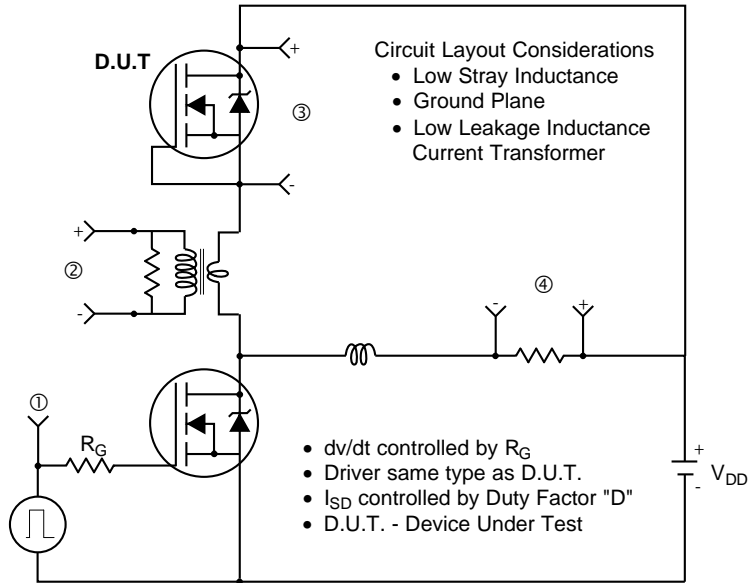

Fig 12c. Maximum Avalanche Energy Vs. Drain Current

Peak Diode Recovery dv/dt Test Circuit



* $V_{GS} = 5V$ for Logic Level Devices

Fig 13. For N-Channel HEXFETS

IRF7413A

Package Outline

SO8 Outline

Dimensions are shown in millimeters (inches)

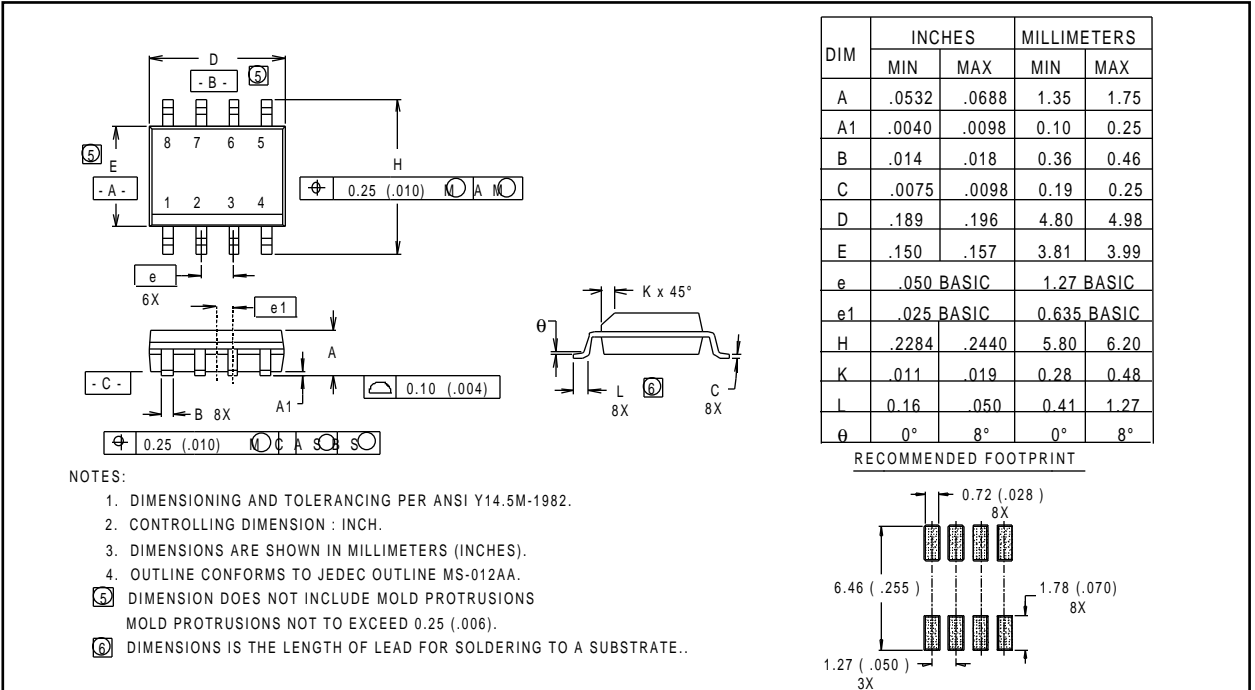

Part Marking Information

SO8

EXAMPLE : THIS IS AN IRF7101

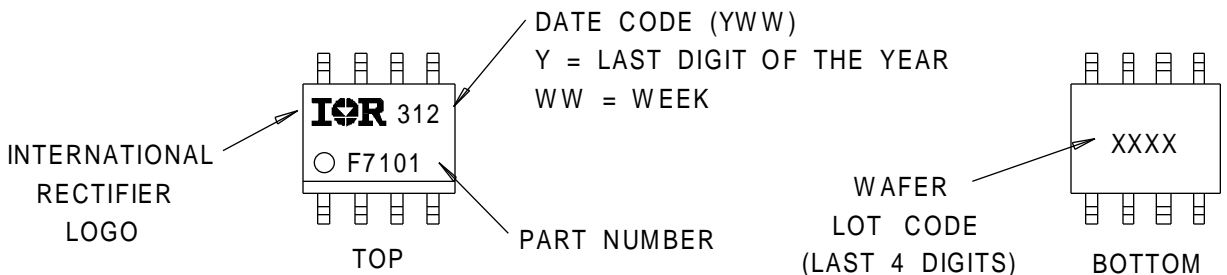

Tape & Reel Information

S08

Dimensions are shown in millimeters (inches)

