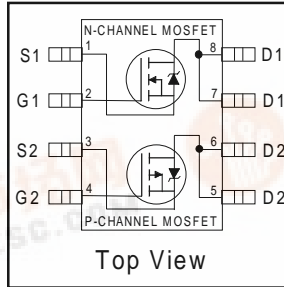


# International Rectifier

# IRF7507

## HEXFET® Power MOSFET

- Generation V Technology
- Ultra Low On-Resistance
- Dual N and P Channel MOSFET
- Very Small SOIC Package
- Low Profile (<1.1mm)
- Available in Tape & Reel
- Fast Switching

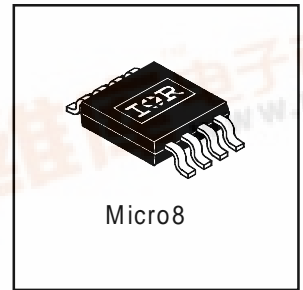


|              | N-Ch           | P-Ch          |
|--------------|----------------|---------------|
| $V_{DS}$     | 20V            | -20V          |
| $R_{DS(on)}$ | 0.135 $\Omega$ | 0.27 $\Omega$ |

### Description

Fifth Generation HEXFETs from International Rectifier utilize advanced processing techniques to achieve extremely low on-resistance per silicon area. This benefit, combined with the fast switching speed and ruggedized device design that HEXFET Power MOSFETs are well known for, provides the designer with an extremely efficient and reliable device for use in a wide variety of applications.

The new Micro8 package, with half the footprint area of the standard SO-8, provides the smallest footprint available in an SOIC outline. This makes the Micro8 an ideal device for applications where printed circuit board space is at a premium. The low profile (<1.1mm) of the Micro8 will allow it to fit easily into extremely thin application environments such as portable electronics and PCMCIA cards.



### Absolute Maximum Ratings

|                          | Parameter   | Max.                  |           | Units |
|--------------------------|---|-----------------------|-----------|-------|
|                          |   | N-Channel             | P-Channel |       |
| $V_{DS}$                 | Drain-Source Voltage                                | 20                    | -20       | V     |
| $I_D @ T_A = 25^\circ C$ | Continuous Drain Current, $V_{GS}$                  | 2.4                   | -1.7      | A     |
| $I_D @ T_A = 70^\circ C$ | Continuous Drain Current, $V_{GS}$                  | 1.9                   | -1.4      |       |
| $I_{DM}$                 | Pulsed Drain Current①                               | 19                    | -14       |       |
| $P_D @ T_A = 25^\circ C$ | Maximum Power Dissipation④                          | 1.25                  |           | W     |
| $P_D @ T_A = 70^\circ C$ | Maximum Power Dissipation④                          | 0.8                   |           | W     |
|                          | Linear Derating Factor                              | 10                    |           | mW/°C |
| $V_{GS}$                 | Gate-to-Source Voltage                              | $\pm 12$              |           | V     |
| $V_{GSM}$                | Gate-to-Source Voltage Single Pulse $t_p < 10\mu S$ | 16                    |           | V     |
| $dv/dt$                  | Peak Diode Recovery $dv/dt$ ②                       | 5.0                   | -5.0      | V/ns  |
| $T_J, T_{STG}$           | Junction and Storage Temperature Range              | -55 to + 150          |           | °C    |
|                          | Soldering Temperature, for 10 seconds               | 240 (1.6mm from case) |           |       |

### Thermal Resistance

|                 | Parameter                     | Max. | Units |
|-----------------|-------------------------------|------|-------|
| $R_{\theta JA}$ | Maximum Junction-to-Ambient ④ | 100  | °C/W  |



## Electrical Characteristics @ T<sub>J</sub> = 25°C (unless otherwise specified)

| Parameter                              | Description                          |      | Min. | Typ.   | Max. | Units | Conditions   |
|--|--------------------------------------|------|------|--------|------|-------|--|
|  |                                      |      |      |        |      |       |  |
| V <sub>(BR)DSS</sub>                   | Drain-to-Source Breakdown Voltage    | N-Ch | 20   | —      | —    | V     | V <sub>GS</sub> = 0V, I <sub>D</sub> = 250μA   |
|  |                                      | P-Ch | -20  | —      | —    |       | V <sub>GS</sub> = 0V, I <sub>D</sub> = -250μA  |
| ΔV <sub>(BR)DSS</sub> /ΔT <sub>J</sub> | Breakdown Voltage Temp. Coefficient  | N-Ch | —    | 0.041  | —    | V/°C  | Reference to 25°C, I <sub>D</sub> = 1mA  |
|  |                                      | P-Ch | —    | -0.012 | —    |       | Reference to 25°C, I <sub>D</sub> = -1mA   |
| R <sub>DS(on)</sub>                    | Static Drain-to-Source On-Resistance | N-Ch | —    | 0.085  | 0.14 | Ω     | V <sub>GS</sub> = 4.5V, I <sub>D</sub> = 1.7A ③  |
|  |                                      |      | —    | 0.120  | 0.20 |       | V <sub>GS</sub> = 2.7V, I <sub>D</sub> = 0.85A ③   |
|  |                                      | P-Ch | —    | 0.17   | 0.27 |       | V <sub>GS</sub> = -4.5V, I <sub>D</sub> = -1.2A ③  |
|  |                                      |      | —    | 0.28   | 0.40 |       | V <sub>GS</sub> = -2.7V, I <sub>D</sub> = -0.6A ③  |
| V <sub>GS(th)</sub>                    | Gate Threshold Voltage               | N-Ch | 0.7  | —      | —    | V     | V <sub>DS</sub> = V <sub>GS</sub> , I <sub>D</sub> = 250μA   |
|  |                                      | P-Ch | -0.7 | —      | —    |       | V <sub>DS</sub> = V <sub>GS</sub> , I <sub>D</sub> = -250μA  |
| g <sub>fs</sub>                        | Forward Transconductance             | N-Ch | 2.6  | —      | —    | S     | V <sub>DS</sub> = 10V, I <sub>D</sub> = 0.85A ③  |
|  |                                      | P-Ch | 1.3  | —      | —    |       | V <sub>DS</sub> = -10V, I <sub>D</sub> = -0.6A ③   |
| I <sub>DSS</sub>                       | Drain-to-Source Leakage Current      | N-Ch | —    | —      | 1.0  | μA    | V <sub>DS</sub> = 16V, V <sub>GS</sub> = 0V  |
|  |                                      | P-Ch | —    | —      | -1.0 |       | V <sub>DS</sub> = -16V, V <sub>GS</sub> = 0V   |
|  |                                      | N-Ch | —    | —      | 25   |       | V <sub>DS</sub> = 16V, V <sub>GS</sub> = 0V, T <sub>J</sub> = 125°C  |
|  |                                      | P-Ch | —    | —      | -25  |       | V <sub>DS</sub> = -16V, V <sub>GS</sub> = 0V, T <sub>J</sub> = 125°C   |
| I <sub>GSS</sub>                       | Gate-to-Source Forward Leakage       | N-P  | —    | —      | ±100 | μA    | V <sub>GS</sub> = ±12V   |
| Q <sub>g</sub>                         | Total Gate Charge                    | N-Ch | —    | 5.3    | 8.0  | nC    | N-Channel<br>I <sub>D</sub> = 1.7A, V <sub>DS</sub> = 16V, V <sub>GS</sub> = 4.5V ④                            |
|  |                                      | P-Ch | —    | 5.4    | 8.2  |       |  |
| Q <sub>gs</sub>                        | Gate-to-Source Charge                | N-Ch | —    | 0.84   | 1.3  | nC    | P-Channel<br>I <sub>D</sub> = -1.2A, V <sub>DS</sub> = -16V, V <sub>GS</sub> = -4.5V ④                         |
|  |                                      | P-Ch | —    | 0.96   | 1.4  |       |  |
| Q <sub>gd</sub>                        | Gate-to-Drain ("Miller") Charge      | N-Ch | —    | 2.2    | 3.3  | nC    | P-Channel<br>I <sub>D</sub> = -1.2A, V <sub>DS</sub> = -16V, V <sub>GS</sub> = -4.5V ④                         |
|  |                                      | P-Ch | —    | 2.4    | 3.6  |       |  |
| t <sub>d(on)</sub>                     | Turn-On Delay Time                   | N-Ch | —    | 5.7    | —    | ns    | N-Channel<br>V <sub>DD</sub> = 10V, I <sub>D</sub> = 1.7A, R <sub>G</sub> = 6.0Ω,<br>R <sub>D</sub> = 5.7Ω ④   |
| P-Ch                                   | —                                    | 9.1  | —    |        |      |       |  |
| t <sub>r</sub>                         | Rise Time                            | N-Ch | —    | 24     | —    | ns    | P-Channel<br>V <sub>DD</sub> = -10V, I <sub>D</sub> = -1.2A, R <sub>G</sub> = 6.0Ω,<br>R <sub>D</sub> = 8.3Ω ④ |
| P-Ch                                   | —                                    | 35   | —    |        |      |       |  |
| t <sub>d(off)</sub>                    | Turn-Off Delay Time                  | N-Ch | —    | 15     | —    | ns    | P-Channel<br>V <sub>DD</sub> = -10V, I <sub>D</sub> = -1.2A, R <sub>G</sub> = 6.0Ω,<br>R <sub>D</sub> = 8.3Ω ④ |
| P-Ch                                   | —                                    | 38   | —    |        |      |       |  |
| t <sub>f</sub>                         | Fall Time                            | N-Ch | —    | 16     | —    | ns    | P-Channel<br>V <sub>DD</sub> = -10V, I <sub>D</sub> = -1.2A, R <sub>G</sub> = 6.0Ω,<br>R <sub>D</sub> = 8.3Ω ④ |
| P-Ch                                   | —                                    | 43   | —    |        |      |       |  |
| C <sub>iss</sub>                       | Input Capacitance                    | N-Ch | —    | 260    | —    | pF    | N-Channel<br>V <sub>GS</sub> = 0V, V <sub>DS</sub> = 15V, f = 1.0MHz ③   |
|  |                                      | P-Ch | —    | 240    | —    |       |  |
| C <sub>oss</sub>                       | Output Capacitance                   | N-Ch | —    | 130    | —    | pF    | P-Channel<br>V <sub>GS</sub> = 0V, V <sub>DS</sub> = -15V, f = 1.0MHz ③  |
|  |                                      | P-Ch | —    | 130    | —    |       |  |
| C <sub>rss</sub>                       | Reverse Transfer Capacitance         | N-Ch | —    | 61     | —    | pF    | P-Channel<br>V <sub>GS</sub> = 0V, V <sub>DS</sub> = -15V, f = 1.0MHz ③  |
|  |                                      | P-Ch | —    | 64     | —    |       |  |

## Source-Drain Ratings and Characteristics

| Parameter       | Description                            |      | Min. | Typ. | Max.  | Units | Conditions   |
|-----------------|--|------|------|------|-------|-------|--|
|                 |  |      |      |      |       |       |  |
| I <sub>S</sub>  | Continuous Source Current (Body Diode) | N-Ch | —    | —    | 1.25  | A     |  |
|                 |  | P-Ch | —    | —    | -1.25 |       |  |
| I <sub>SM</sub> | Pulsed Source Current (Body Diode) ①   | N-Ch | —    | —    | 19    | A     |  |
|                 |  | P-Ch | —    | —    | -14   |       |  |
| V <sub>SD</sub> | Diode Forward Voltage                  | N-Ch | —    | —    | 1.2   | V     | T <sub>J</sub> = 25°C, I <sub>S</sub> = 1.7A, V <sub>GS</sub> = 0V ③           |
|                 |  | P-Ch | —    | —    | -1.2  |       | T <sub>J</sub> = 25°C, I <sub>S</sub> = -1.2A, V <sub>GS</sub> = 0V ③          |
| t <sub>rr</sub> | Reverse Recovery Time                  | N-Ch | —    | 39   | 59    | ns    | N-Channel<br>T <sub>J</sub> = 25°C, I <sub>F</sub> = 1.7A, di/dt = 100A/μs     |
|                 |  | P-Ch | —    | 52   | 78    |       |  |
| Q <sub>rr</sub> | Reverse Recovery Charge                | N-Ch | —    | 37   | 56    | nC    | P-Channel<br>T <sub>J</sub> = 25°C, I <sub>F</sub> = -1.2A, di/dt = -100A/μs ③ |
|                 |  | P-Ch | —    | 63   | 95    |       |  |

### Notes:

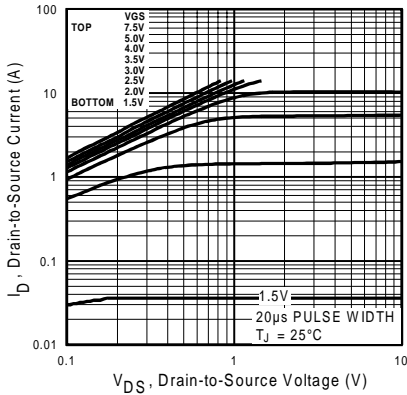
① Repetitive rating; pulse width limited by max. junction temperature. ( See fig. 21 )

② N-Channel I<sub>SD</sub> ≤ 1.7A, di/dt ≤ 66A/μs, V<sub>DD</sub> ≤ V<sub>(BR)DSS</sub>, T<sub>J</sub> ≤ 150°C  
P-Channel I<sub>SD</sub> ≤ -1.2A, di/dt ≤ 100A/μs, V<sub>DD</sub> ≤ V<sub>(BR)DSS</sub>, T<sub>J</sub> ≤ 150°C

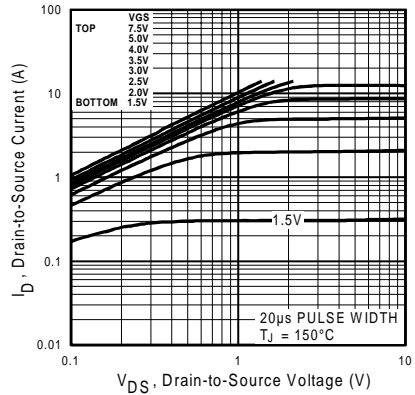
③ Pulse width ≤ 300μs; duty cycle ≤ 2%.

④ Surface mounted on FR-4 board, t ≤ 10sec.

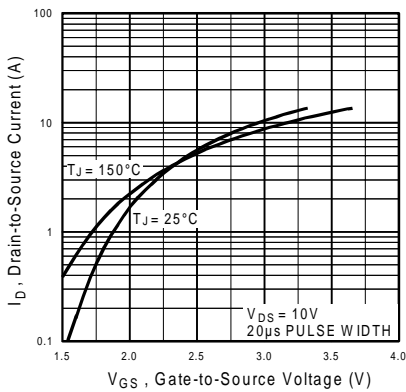
N - Channel



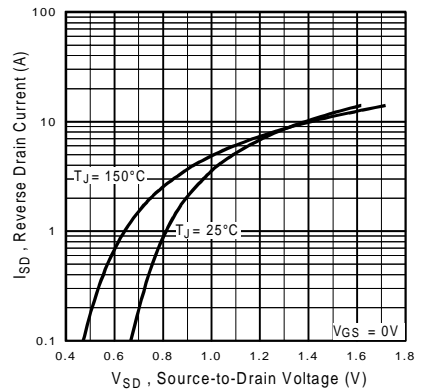
**Fig 1.** Typical Output Characteristics



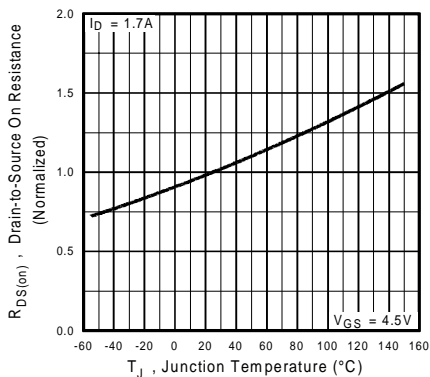
**Fig 2.** Typical Output Characteristics



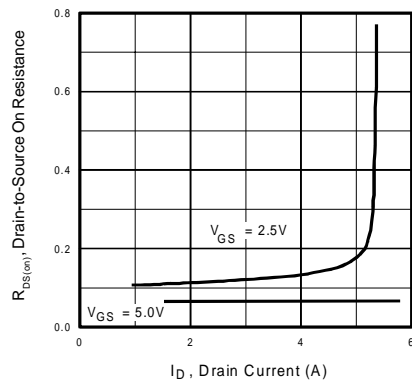
**Fig 3.** Typical Transfer Characteristics



**Fig 4.** Typical Source-Drain Diode Forward Voltage



**Fig 5.** Normalized On-Resistance Vs. Temperature

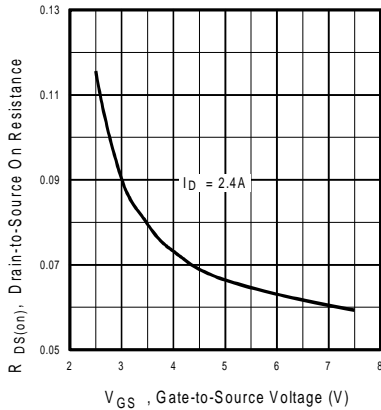


**Fig 6.** Typical On-Resistance Vs. Drain Current

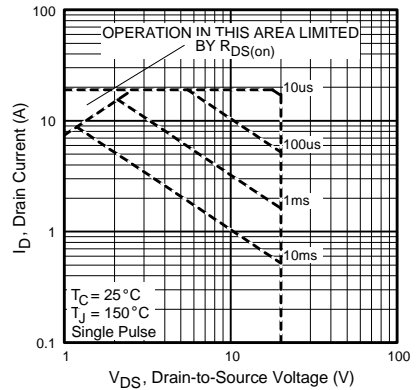
# IRF7507

International  
**IR** Rectifier

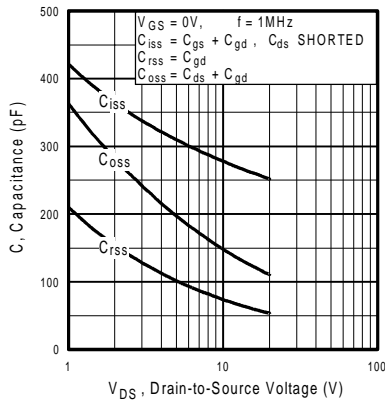
N - Channel



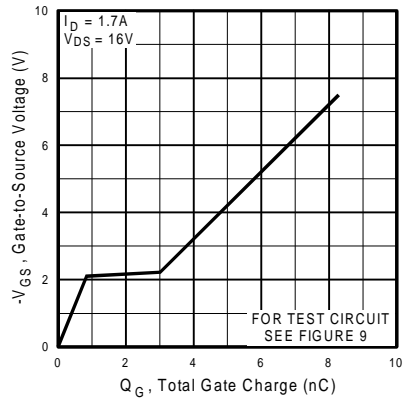
**Fig 7.** Typical On-Resistance Vs. Gate Voltage



**Fig 8.** Maximum Safe Operating Area

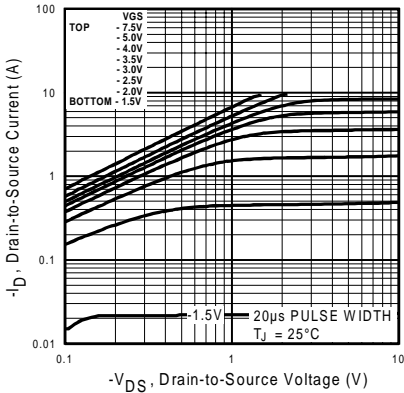


**Fig 9.** Typical Capacitance Vs. Drain-to-Source Voltage

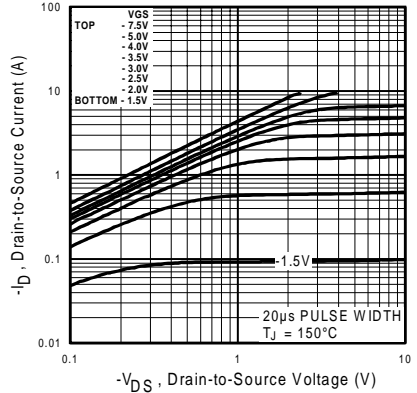


**Fig 10.** Typical Gate Charge Vs. Gate-to-Source Voltage

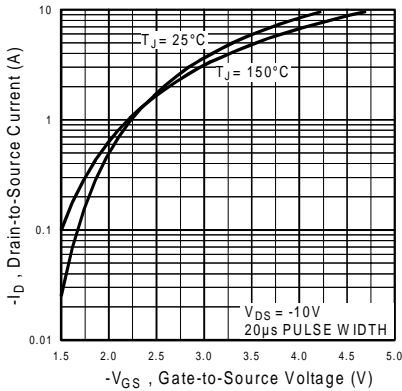
P - Channel



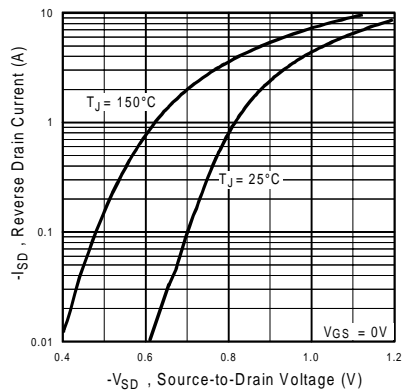
**Fig 11.** Typical Output Characteristics



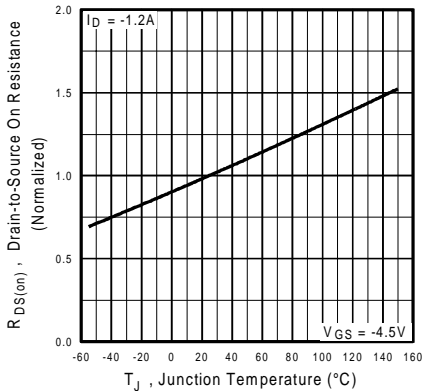
**Fig 12.** Typical Output Characteristics



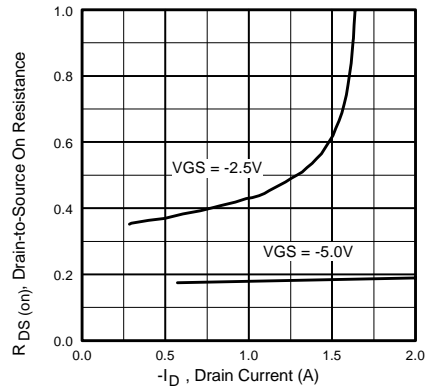
**Fig 13.** Typical Transfer Characteristics



**Fig 14.** Typical Source-Drain Diode Forward Voltage



**Fig 15.** Normalized On-Resistance Vs. Temperature

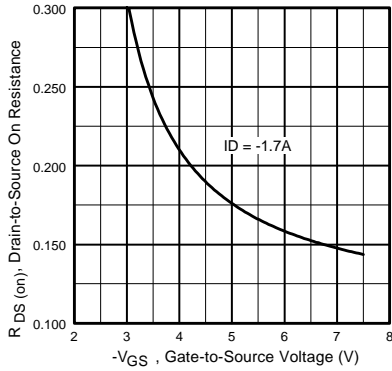


**Fig 16.** Typical On-Resistance Vs. Drain Current

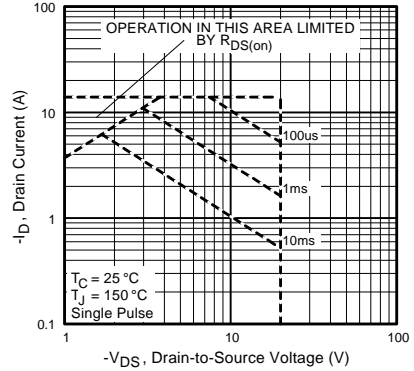
# IRF7507

International  
**IOR** Rectifier

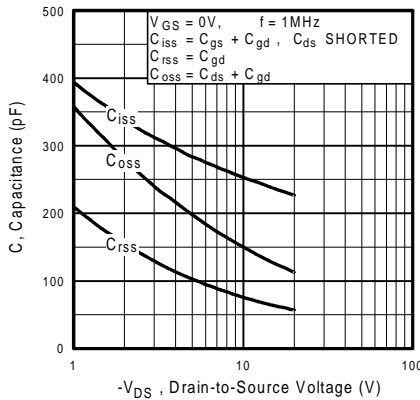
P - Channel



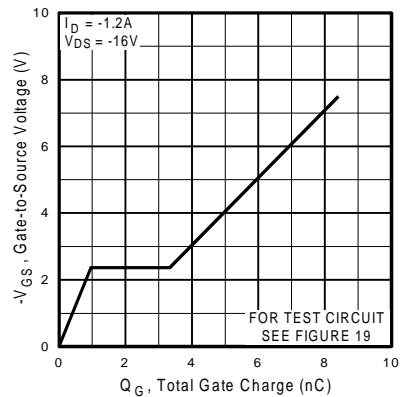
**Fig 17. Typical On-Resistance Vs. Gate Voltage**



**Fig 18. Maximum Safe Operating Area**

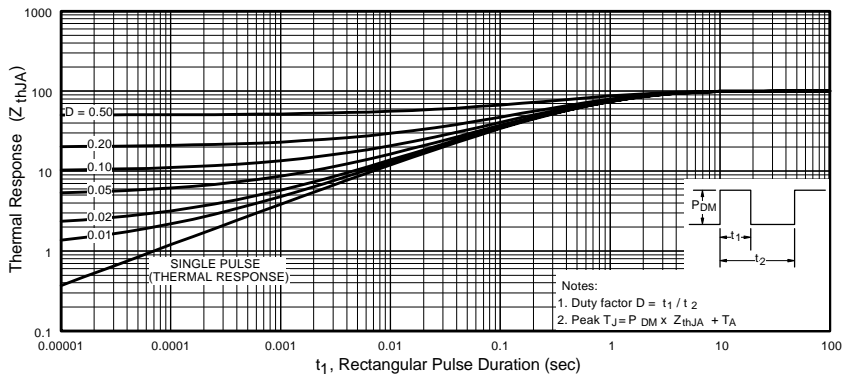


**Fig 19. Typical Capacitance Vs. Drain-to-Source Voltage**



**Fig 20. Typical Gate Charge Vs. Gate-to-Source Voltage**

N-P - Channel

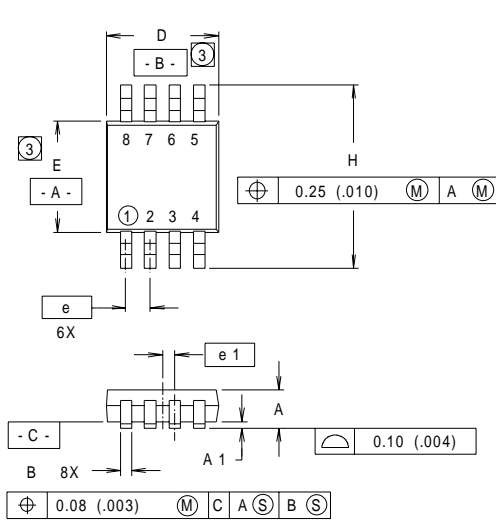


**Fig 21. Maximum Effective Transient Thermal Impedance, Junction-to-Ambient**

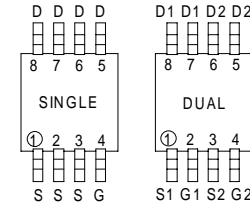
## Package Outline

### Micro8 Outline

Dimensions are shown in millimeters (inches)

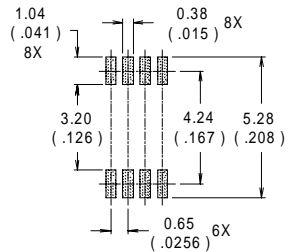


### LEAD ASSIGNMENTS



| DIM | INCHES      |      | MILLIMETERS |      |
|-----|-------------|------|-------------|------|
|     | MIN         | MAX  | MIN         | MAX  |
| A   | .036        | .044 | 0.91        | 1.11 |
| A1  | .004        | .008 | 0.10        | 0.20 |
| B   | .010        | .014 | 0.25        | 0.36 |
| C   | .005        | .007 | 0.13        | 0.18 |
| D   | .116        | .120 | 2.95        | 3.05 |
| e   | .0256 BASIC |      | 0.65 BASIC  |      |
| e1  | .0128 BASIC |      | 0.33 BASIC  |      |
| E   | .116        | .120 | 2.95        | 3.05 |
| H   | .188        | .198 | 4.78        | 5.03 |
| L   | .016        | .026 | 0.41        | 0.66 |
| θ   | 0°          | 6°   | 0°          | 6°   |

### RECOMMENDED FOOTPRINT



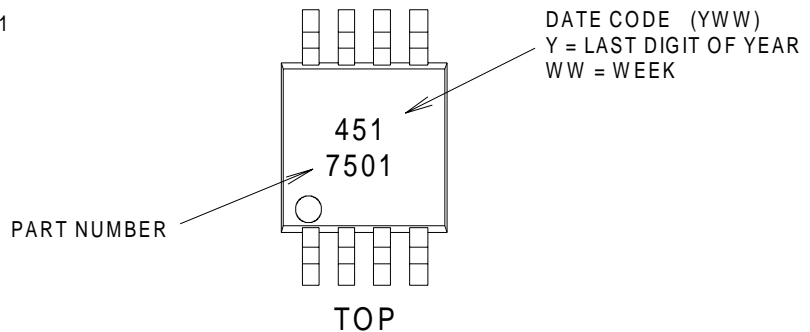
### NOTES:

- 1 DIMENSIONING AND TOLERANCING PER ANSI Y14.5M-1982.
- 2 CONTROLLING DIMENSION : INCH.
- 3 DIMENSIONS DO NOT INCLUDE MOLD FLASH.

## Part Marking Information

### Micro8

EXAMPLE : THIS IS AN IRF7501



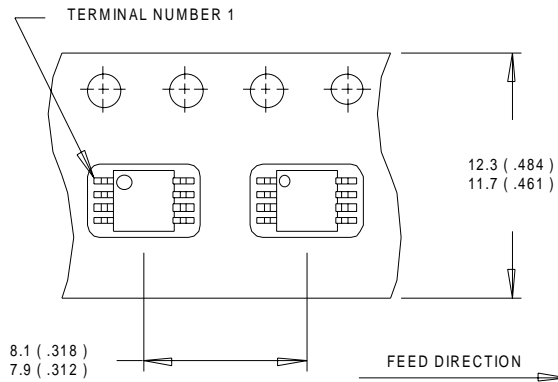
# IRF7507

International  
**IOR** Rectifier

## Tape & Reel Information

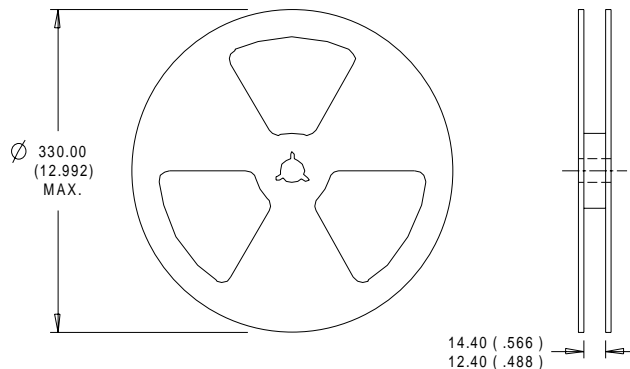
### Micro8

Dimensions are shown in millimeters (inches)



#### NOTES:

1. OUTLINE CONFORMS TO EIA-481 & EIA-541.
2. CONTROLLING DIMENSION : MILLIMETER.



#### NOTES:

1. CONTROLLING DIMENSION : MILLIMETER.
2. OUTLINE CONFORMS TO EIA-481 & EIA-541.

International  
**IOR** Rectifier

**WORLD HEADQUARTERS:** 233 Kansas St., El Segundo, California 90245, Tel: (310) 322 3331

**IR GREAT BRITAIN:** Hurst Green, Oxted, Surrey RH8 9BB, UK Tel: ++ 44 1883 732020

**IR CANADA:** 15 Lincoln Court, Brampton, Ontario L6T3Z2, Tel: (905) 453 2200

**IR GERMANY:** Saalburgstrasse 157, 61350 Bad Homburg Tel: ++ 49 6172 96590

**IR ITALY:** Via Liguria 49, 10071 Borgaro, Torino Tel: ++ 39 11 451 0111

**IR FAR EAST:** K&H Bldg., 2F, 30-4 Nishi-Ikebukuro 3-Chome, Toshima-Ku, Tokyo Japan 171 Tel: 81 3 3983 0086

**IR SOUTHEAST ASIA:** 1 Kim Seng Promenade, Great World City West Tower, 13-11, Singapore 237994 Tel: ++ 65 838 4630

**IR TAIWAN:** 16 Fl. Suite D. 207, Sec. 2, Tun Haw South Road, Taipei, 10673, Taiwan Tel: 886-2-2377-9936

<http://www.irf.com/> Data and specifications subject to change without notice. 12/98