

International IR Rectifier

PD -94064

IRF7726

HEXFET® Power MOSFET

- Ultra Low On-Resistance
- P-Channel MOSFET
- Very Small SOIC Package
- Low Profile (< 1.2mm)
- Available in Tape & Reel

V_{DS}	$R_{DS(on)}$ max	I_D
-30V	0.026@ $V_{GS} = -10V$	-7.0A
	0.040@ $V_{GS} = -4.5V$	-6.0A

Description

HEXFET® Power MOSFETs from International Rectifier utilize advanced processing techniques to achieve extremely low on-resistance per silicon area. This benefit, combined with the ruggedized device design, that International Rectifier is well known for, provides the designer with an extremely efficient and reliable device for battery and load management.

The new Micro8 package, with half the footprint area of the standard SO-8, provides the smallest footprint available in an SOIC outline. This makes the Micro8 an ideal device for applications where printed circuit board space is at a premium. The low profile (<1.2mm) of the Micro8 will allow it to fit easily into extremely thin application environments such as portable electronics and PCMCIA cards.

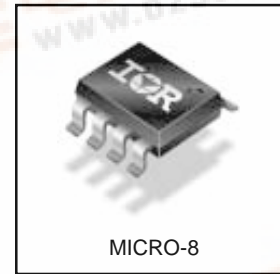
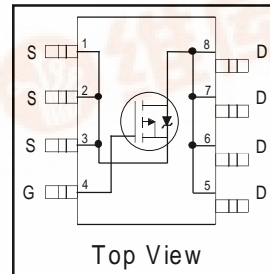

Absolute Maximum Ratings

	Parameter	Max.	Units
V_{DS}	Drain-Source Voltage	-30	V
I_D @ $T_A = 25^\circ C$	Continuous Drain Current, V_{GS} @ -10V	-7.0	A
I_D @ $T_A = 70^\circ C$	Continuous Drain Current, V_{GS} @ -10V	-5.7	
I_{DM}	Pulsed Drain Current ^①	-28	
P_D @ $T_A = 25^\circ C$	Maximum Power Dissipation ^③	1.79	W
P_D @ $T_A = 70^\circ C$	Maximum Power Dissipation ^③	1.14	W
	Linear Derating Factor	0.01	W/°C
V_{GS}	Gate-to-Source Voltage	± 20	V
T_J, T_{STG}	Junction and Storage Temperature Range	-55 to +150	°C

Thermal Resistance

	Parameter	Max.	Units
$R_{\theta JA}$	Maximum Junction-to-Ambient ^③	70	°C/W



Electrical Characteristics @ $T_J = 25^\circ\text{C}$ (unless otherwise specified)

	Parameter	Min.	Typ.	Max.	Units	Conditions
$V_{(BR)DSS}$	Drain-to-Source Breakdown Voltage	-30	—	—	V	$V_{GS} = 0V, I_D = -250\mu A$
$\Delta V_{(BR)DSS}/\Delta T_J$	Breakdown Voltage Temp. Coefficient	—	0.016	—	V/°C	Reference to $25^\circ\text{C}, I_D = -1\text{mA}$
$R_{DS(on)}$	Static Drain-to-Source On-Resistance	—	—	0.026	Ω	$V_{GS} = -10V, I_D = -7.0A$ ②
		—	—	0.040		$V_{GS} = -4.5V, I_D = -6.0A$ ②
$V_{GS(th)}$	Gate Threshold Voltage	-1.0	—	-2.5	V	$V_{DS} = V_{GS}, I_D = -250\mu A$
g_{fs}	Forward Transconductance	10	—	—	S	$V_{DS} = -10V, I_D = -7.0A$
I_{DSS}	Drain-to-Source Leakage Current	—	—	-15	μA	$V_{DS} = -24V, V_{GS} = 0V$
		—	—	-25		$V_{DS} = -24V, V_{GS} = 0V, T_J = 70^\circ\text{C}$
I_{GSS}	Gate-to-Source Forward Leakage	—	—	-100	nA	$V_{GS} = -20V$
	Gate-to-Source Reverse Leakage	—	—	100		$V_{GS} = 20V$
Q_g	Total Gate Charge	—	46	69	nC	$I_D = -7.0A$
Q_{gs}	Gate-to-Source Charge	—	8.0	—		$V_{DS} = -15V$
Q_{gd}	Gate-to-Drain ("Miller") Charge	—	8.1	—		$V_{GS} = -10V$
$t_{d(on)}$	Turn-On Delay Time	—	15	23	ns	$V_{DD} = -15V, V_{GS} = -10V$
t_r	Rise Time	—	25	38		$I_D = -1.0A$
$t_{d(off)}$	Turn-Off Delay Time	—	227	341		$R_G = 6.0\Omega$
t_f	Fall Time	—	107	161		$R_D = 15\Omega$ ②
C_{iss}	Input Capacitance	—	2204	—	pF	$V_{GS} = 0V$
C_{oss}	Output Capacitance	—	341	—		$V_{DS} = -25V$
C_{rss}	Reverse Transfer Capacitance	—	220	—		$f = 1.0\text{MHz}$

Source-Drain Ratings and Characteristics

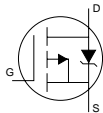
	Parameter	Min.	Typ.	Max.	Units	Conditions
I_S	Continuous Source Current (Body Diode)	—	—	-1.8	A	MOSFET symbol showing the integral reverse p-n junction diode. 
I_{SM}	Pulsed Source Current (Body Diode) ①	—	—	-28		
V_{SD}	Diode Forward Voltage	—	—	-1.2	V	$T_J = 25^\circ\text{C}, I_S = -1.8A, V_{GS} = 0V$ ②
t_{rr}	Reverse Recovery Time	—	35	53	ns	$T_J = 25^\circ\text{C}, I_F = -1.8A$
Q_{rr}	Reverse Recovery Charge	—	32	48	μC	$di/dt = -100A/\mu s$ ②

Notes:

① Repetitive rating; pulse width limited by max. junction temperature.

② Pulse width $\leq 400\mu s$; duty cycle $\leq 2\%$.

③ When mounted on 1 inch square copper board, $t < 10$ sec.

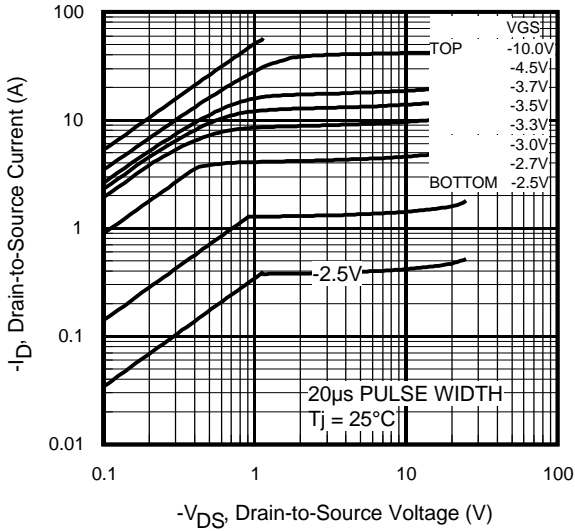

Fig 1. Typical Output Characteristics

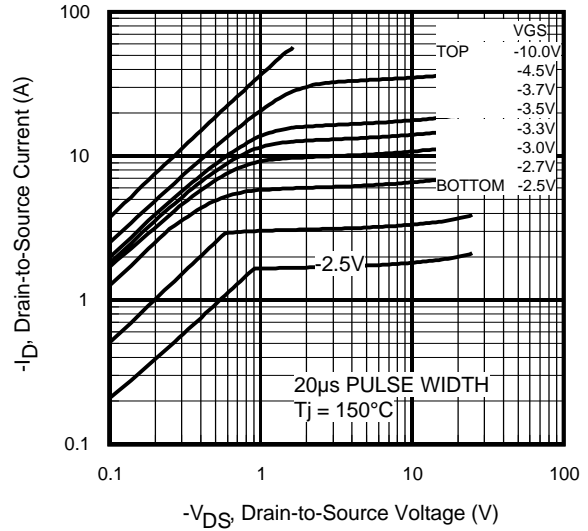

Fig 2. Typical Output Characteristics

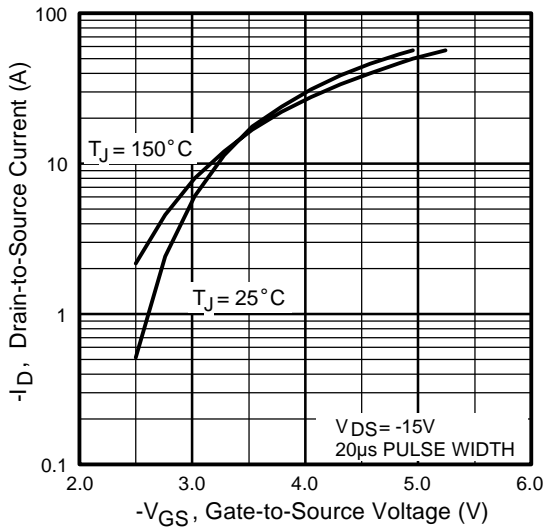

Fig 3. Typical Transfer Characteristics

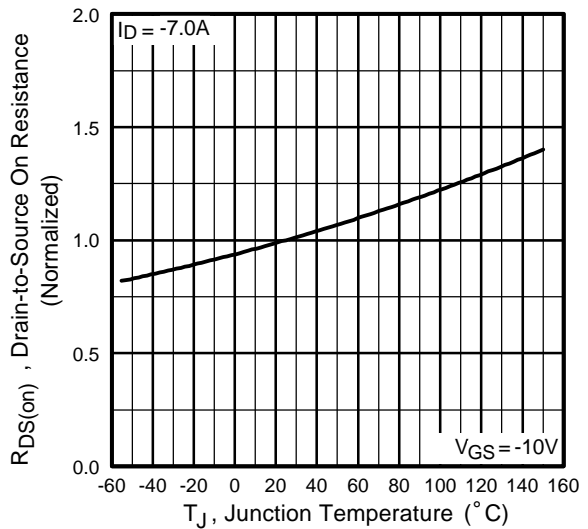

Fig 4. Normalized On-Resistance Vs. Temperature

IRF7726

International
IR Rectifier

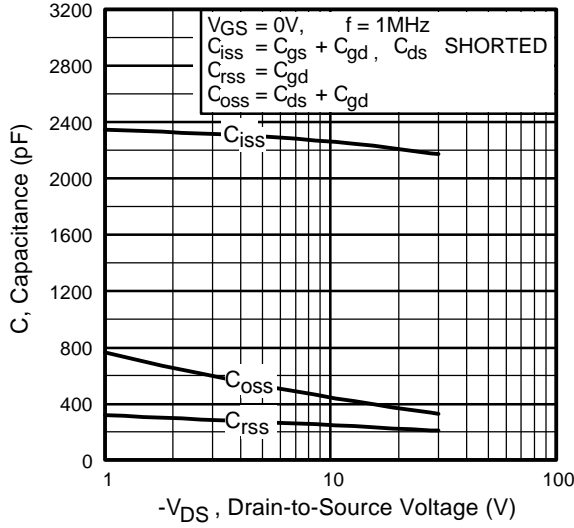

Fig 5. Typical Capacitance Vs. Drain-to-Source Voltage

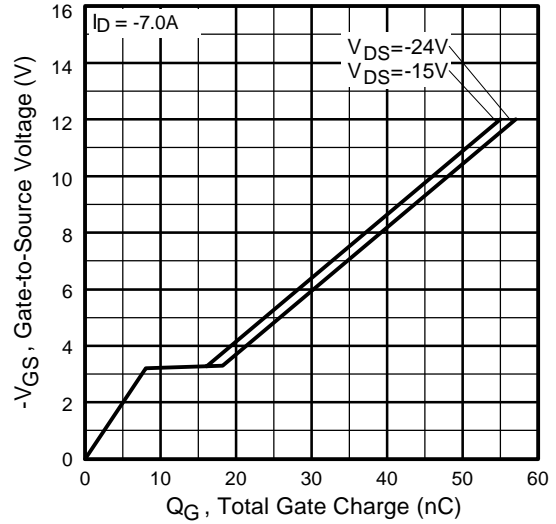

Fig 6. Typical Gate Charge Vs. Gate-to-Source Voltage

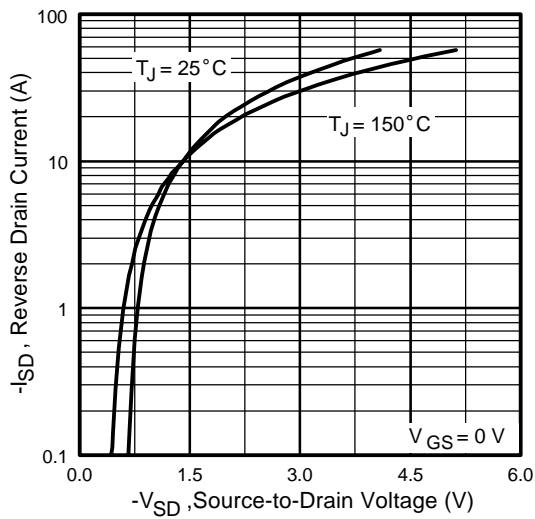

Fig 7. Typical Source-Drain Diode Forward Voltage

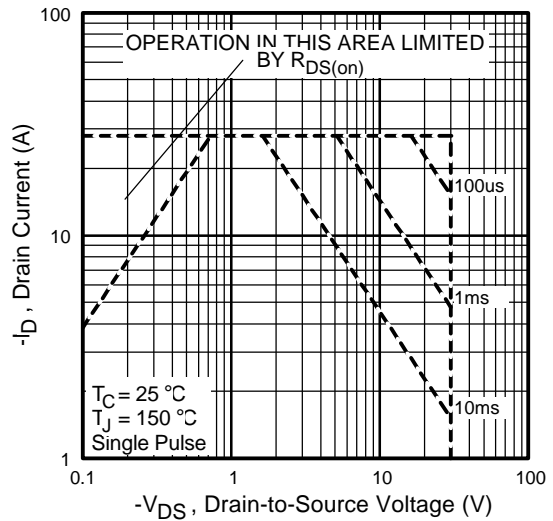

Fig 8. Maximum Safe Operating Area

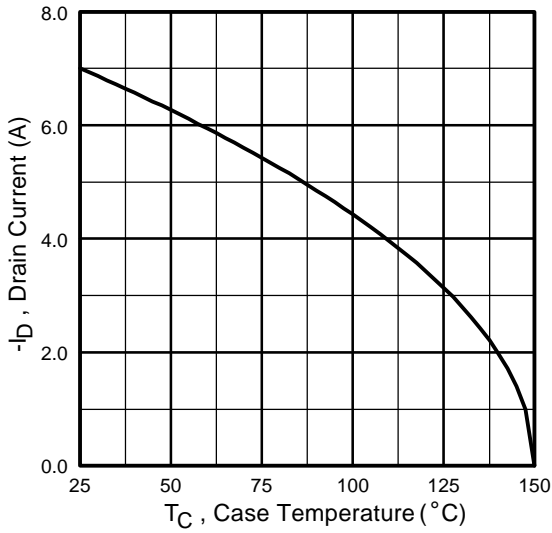

Fig 9. Maximum Drain Current Vs. Case Temperature

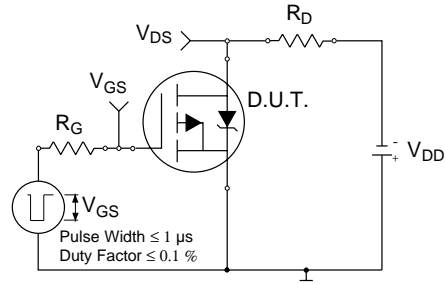

Fig 10a. Switching Time Test Circuit

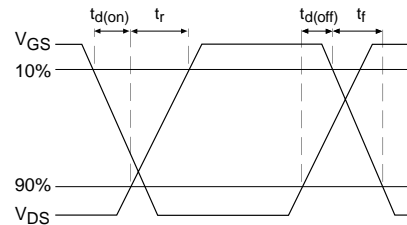

Fig 10b. Switching Time Waveforms

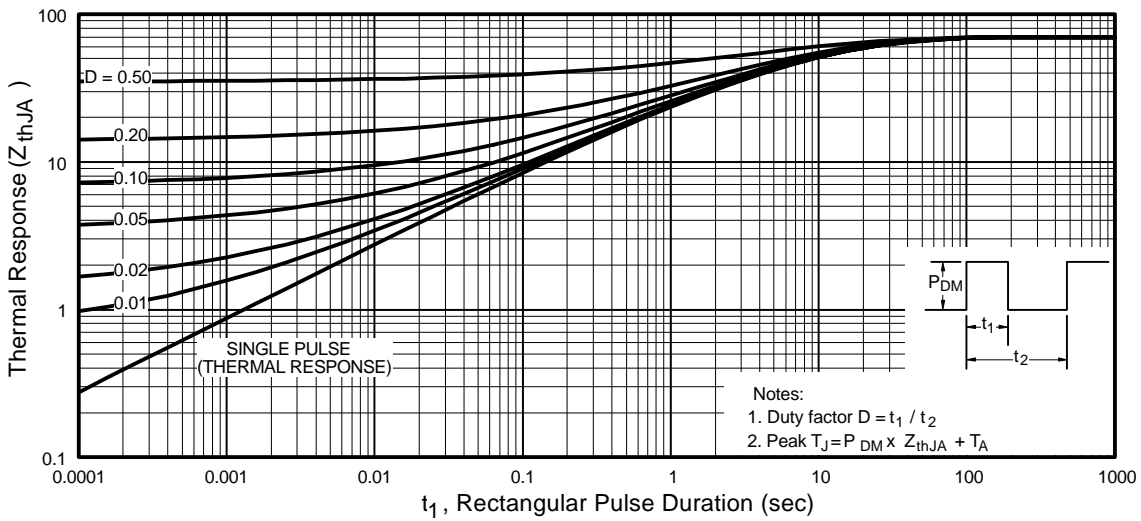

Fig 11. Maximum Effective Transient Thermal Impedance, Junction-to-Ambient

IRF7726

International
IR Rectifier

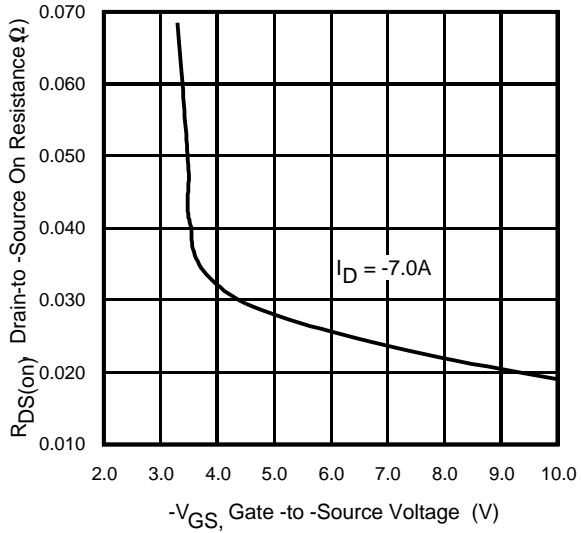

Fig 12. Typical On-Resistance Vs. Gate Voltage

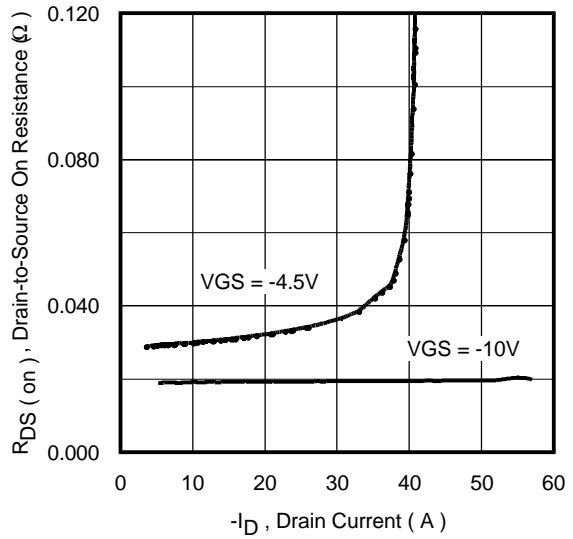

Fig 13. Typical On-Resistance Vs. Drain Current

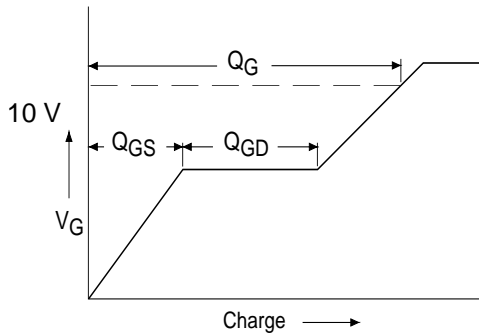

Fig 14a. Basic Gate Charge Waveform

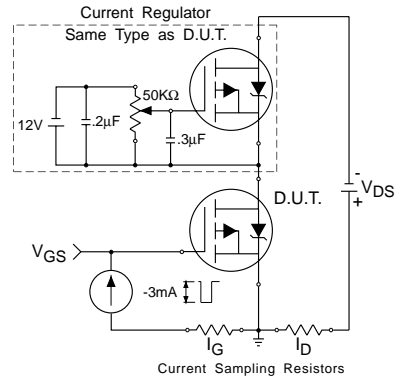

Fig 14b. Gate Charge Test Circuit

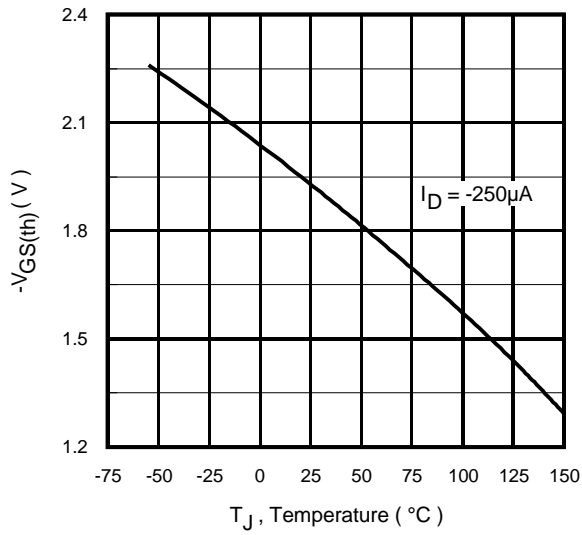

Fig 15. Typical $V_{GS(th)}$ Vs. Junction Temperature

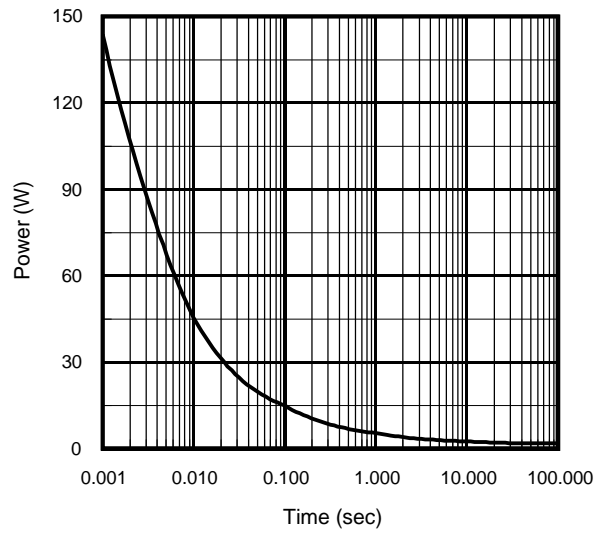

Fig 16. Typical Power Vs. Time

IRF7726

Package Outline

Micro-8 Outline

Dimensions are shown in millimeters (inches)

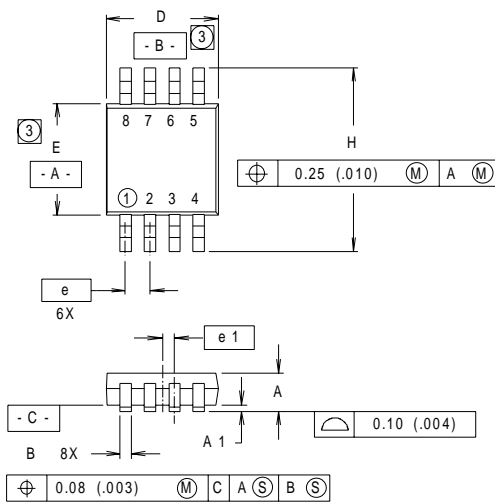

LEAD ASSIGNMENTS

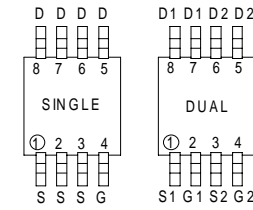

DIM	INCHES		MILLIMETERS	
	MIN	MAX	MIN	MAX
A	.036	.044	0.91	1.11
A1	.004	.008	0.10	0.20
B	.010	.014	0.25	0.36
C	.005	.007	0.13	0.18
D	.116	.120	2.95	3.05
e	.0256 BASIC		0.65 BASIC	
e1	.0128 BASIC		0.33 BASIC	
E	.116	.120	2.95	3.05
H	.188	.198	4.78	5.03
L	.016	.026	0.41	0.66
θ	0°	6°	0°	6°

RECOMMENDED FOOTPRINT

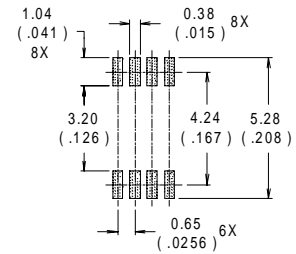

NOTES:

- 1 DIMENSIONING AND TOLERANCING PER ANSI Y14.5M-1982.
- 2 CONTROLLING DIMENSION : INCH.
- 3 DIMENSIONS DO NOT INCLUDE MOLD FLASH.

Part Marking Information

Micro-8

EXAMPLE : THIS IS AN IRF7501

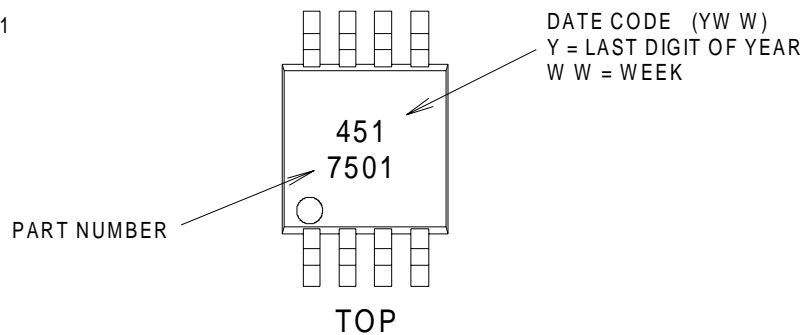

Tape & Reel Information

Micro-8

Dimensions are shown in millimeters (inches)

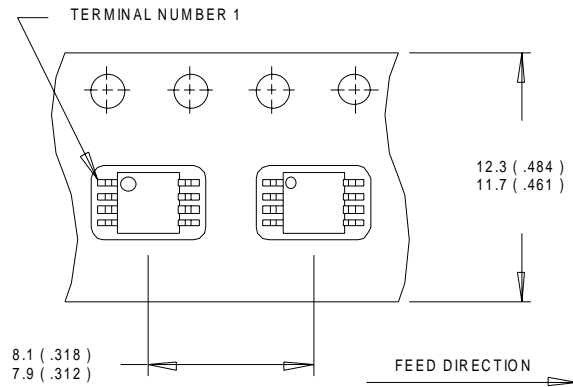

NOTES:

1. OUTLINE CONFORMS TO EIA-481 & EIA-541.
2. CONTROLLING DIMENSION : MILLIMETER.

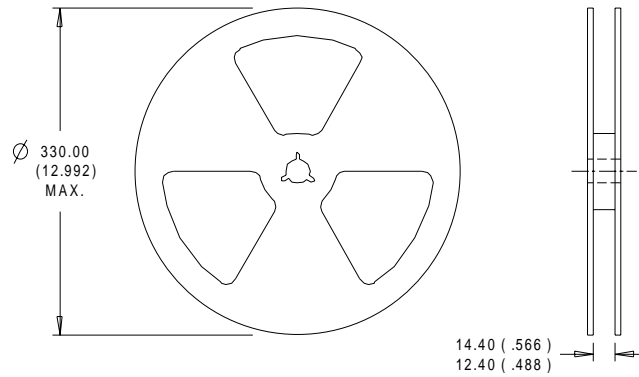

NOTES :

1. CONTROLLING DIMENSION : MILLIMETER.
2. OUTLINE CONFORMS TO EIA-481 & EIA-541.

Data and specifications subject to change without notice.
This product has been designed and qualified for the commercial market.
Qualification Standards can be found on IR's Web site.