

International IOR Rectifier

HFA80NC40C

HEXFRED™

Ultrafast, Soft Recovery Diode

Features

- Reduced RFI and EMI
- Reduced Snubbing
- Extensive Characterization of Recovery Parameters

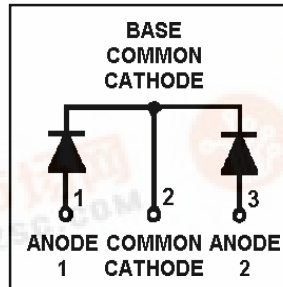

$V_R = 400V$
$V_F(\text{typ.})^{\text{③}} = 1V$
$I_F(\text{AV}) = 80A$
$Q_{rr}(\text{typ.}) = 200nC$
$I_{RRM}(\text{typ.}) = 6A$
$t_{rr}(\text{typ.}) = 30ns$
$di_{(rec)}/dt(\text{typ.})^{\text{③}} = 190A/\mu s$

Description

HEXFRED™ diodes are optimized to reduce losses and EMI/RFI in high frequency power conditioning systems. An extensive characterization of the recovery behavior for different values of current, temperature and di/dt simplifies the calculations of losses in the operating conditions. The softness of the recovery eliminates the need for a snubber in most applications. These devices are ideally suited for power converters, motors drives and other applications where switching losses are significant portion of the total losses.

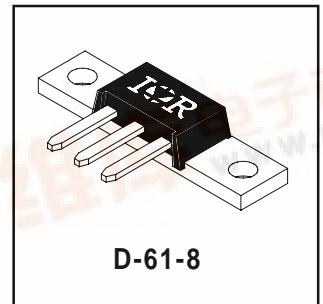

Absolute Maximum Ratings (per Leg)

	Parameter	Max.	Units
V_R	Cathode-to-Anode Voltage	400	V
$I_F @ T_C = 25^\circ C$	Continuous Forward Current	85	A
$I_F @ T_C = 100^\circ C$	Continuous Forward Current	42	
I_{FSM}	Single Pulse Forward Current ①	300	
E_{AS}	Non-Repetitive Avalanche Energy ②	1.4	mJ
$P_D @ T_C = 25^\circ C$	Maximum Power Dissipation	150	W
$P_D @ T_C = 100^\circ C$	Maximum Power Dissipation	59	
T_J	Operating Junction and	-55 to +150	°C
T_{STG}	Storage Temperature Range		

Thermal - Mechanical Characteristics

	Parameter	Min.	Typ.	Max.	Units
R_{thJC}	Junction-to-Case, Single Leg Conducting	—	—	0.85	°C/W K/W
	Junction-to-Case, Both Legs Conducting	—	—	0.42	
R_{thCS}	Case-to-Sink, Flat , Greased Surface	—	0.30	—	
Wt	Weight	—	7.8 (0.28)	—	g (oz)
	Mounting Torque	35 (4.0)	—	50 (5.7)	lbf•in (N•m)

Note: ① Limited by junction temperature
② $L = 100\mu H$, duty cycle limited by max T_J



HFA80NC40C

PD-2.473 rev. B 01/99

International
IOR Rectifier

Electrical Characteristics (per Leg) @ $T_J = 25^\circ\text{C}$ (unless otherwise specified)

Parameter	Min.	Typ.	Max.	Units	Test Conditions
V_{BR}	400	—	—	V	$I_R = 100\mu\text{A}$
V_{FM}	—	1.1	1.3	V	$I_F = 40\text{A}$ $I_F = 80\text{A}$ See Fig. 1 $I_F = 40\text{A}, T_J = 125^\circ\text{C}$
		1.3	1.5		
		1.0	1.2		
I_{RM}	—	0.50	3.0	μA	$V_R = V_R$ Rated $T_J = 125^\circ\text{C}, V_R = 320\text{V}$ See Fig. 2
		0.75	4.0		
C_T	—	90	125	pF	$V_R = 200\text{V}$ See Fig. 3
L_S	—	5.5	—	nH	Lead to lead 5mm from package body

Dynamic Recovery Characteristics (per Leg) @ $T_J = 25^\circ\text{C}$ (unless otherwise specified)

Parameter	Min.	Typ.	Max.	Units	Test Conditions
t_{rr}	—	30	—	ns	$I_F = 1.0\text{A}, di/dt = 200\text{A}/\mu\text{s}, V_R = 30\text{V}$ $T_J = 25^\circ\text{C}$ See Fig. 4 $T_J = 125^\circ\text{C}$ 5
t_{rr1}	—	67	100		
t_{rr2}	—	110	170		
I_{RRM1}	—	6.0	11	A	$T_J = 25^\circ\text{C}$ See Fig. 5 $T_J = 125^\circ\text{C}$ 6
		I_{RRM2}	—		
Q_{rr1}	—	200	540	nC	$T_J = 25^\circ\text{C}$ See Fig. 6 $T_J = 125^\circ\text{C}$ 7
Q_{rr2}	—	500	1300		
$di_{(rec)M}/dt1$	—	240	—	A/ μs	$T_J = 25^\circ\text{C}$ See Fig. 7 $T_J = 125^\circ\text{C}$ 8
$di_{(rec)M}/dt2$	—	190	—		

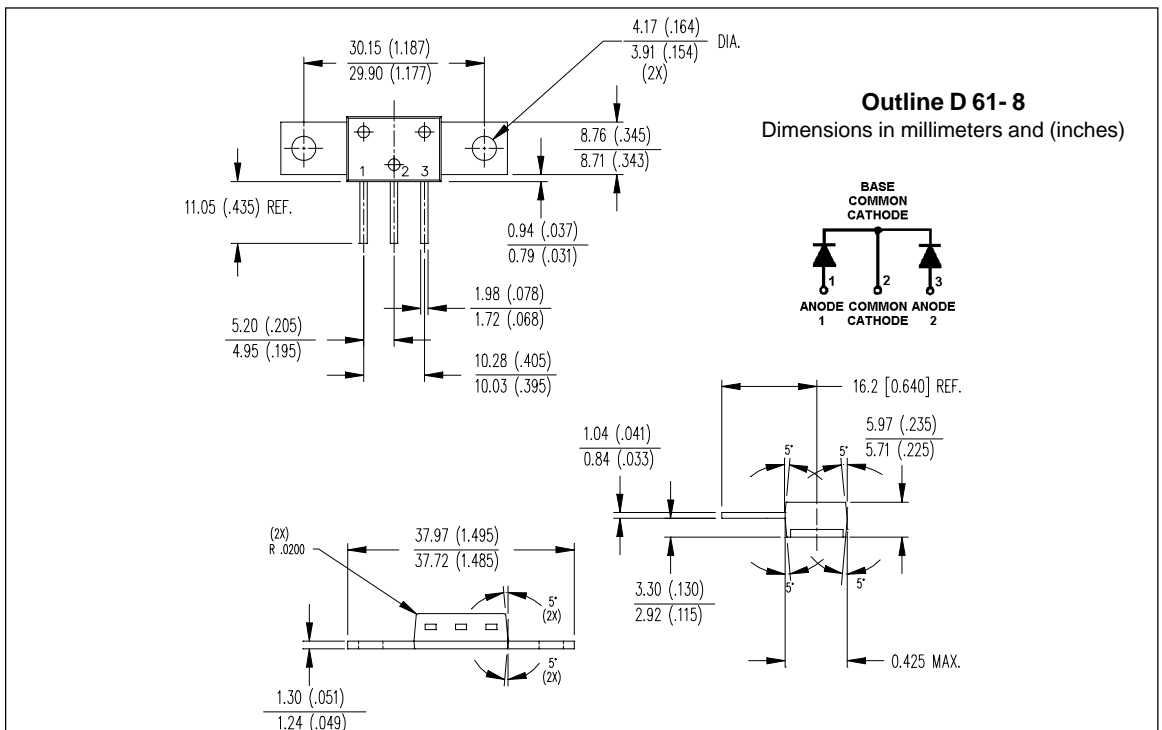

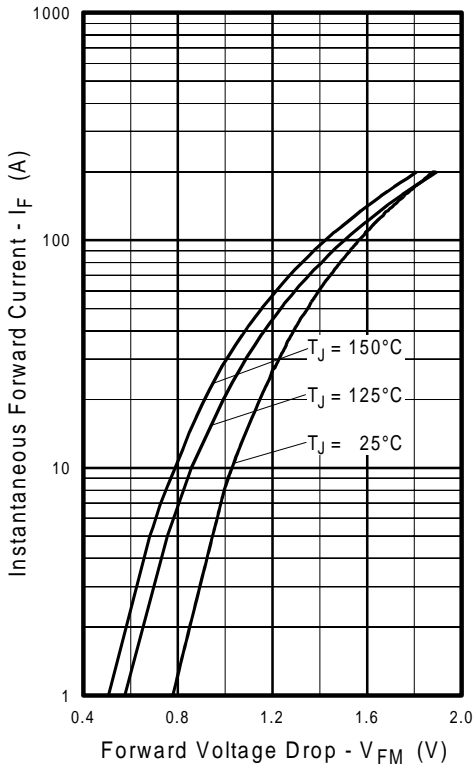

Fig. 1 - Maximum Forward Voltage Drop vs. Instantaneous Forward Current, (per Leg)

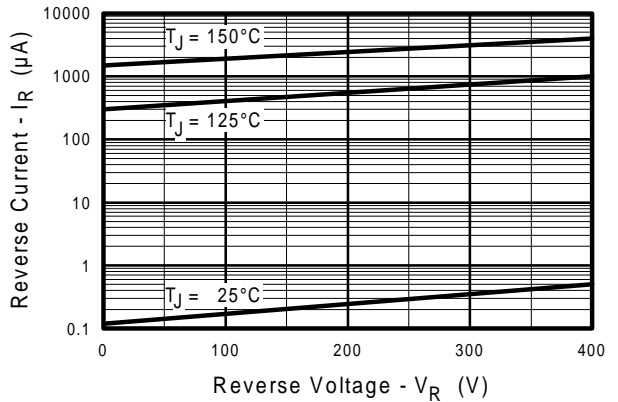

Fig. 2 - Typical Reverse Current vs. Reverse Voltage, (per Leg)

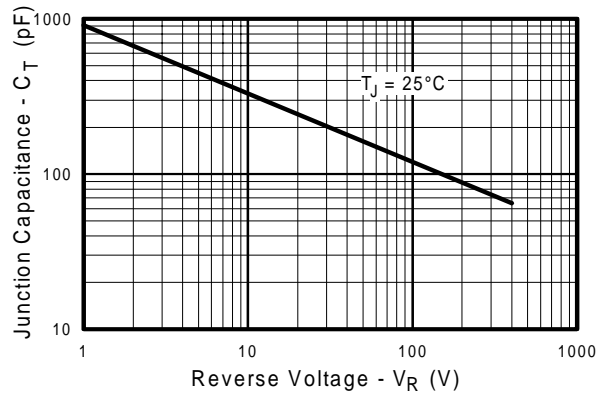

Fig. 3 - Typical Junction Capacitance vs. Reverse Voltage, (per Leg)

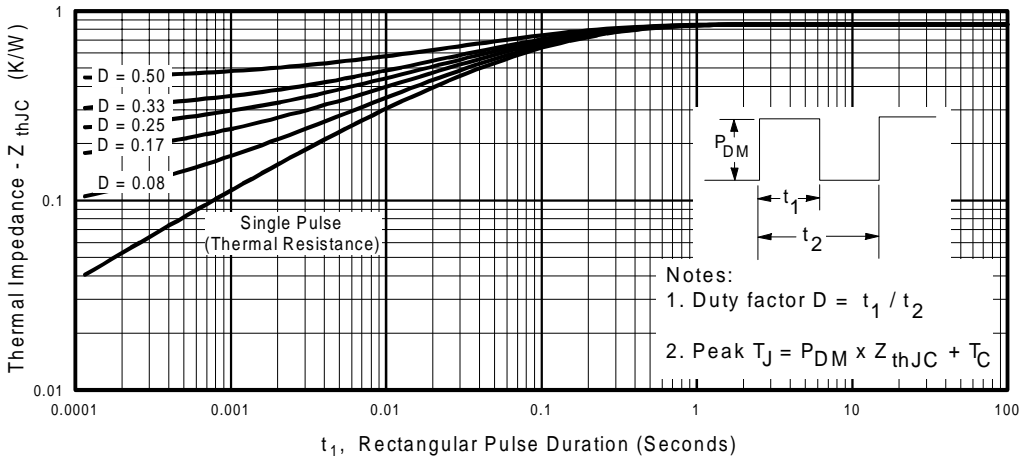

Fig. 4 - Maximum Thermal Impedance Z_{thJC} Characteristics, (per Leg)

HFA80NC40C

PD-2.473 rev. B 01/99

International
IOR Rectifier

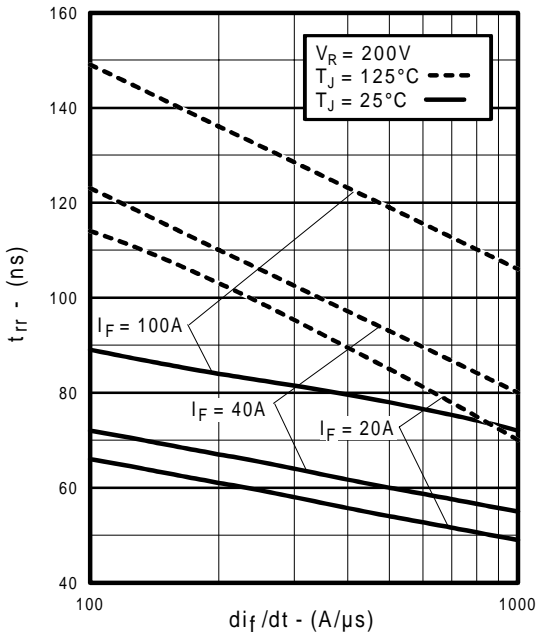

Fig. 5 - Typical Reverse Recovery vs. di_f/dt , (per Leg)

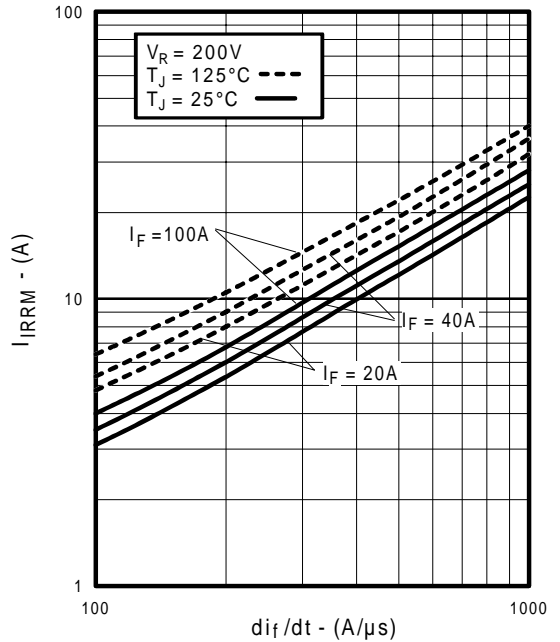

Fig. 6 - Typical Recovery Current vs. di_f/dt , (per Leg)

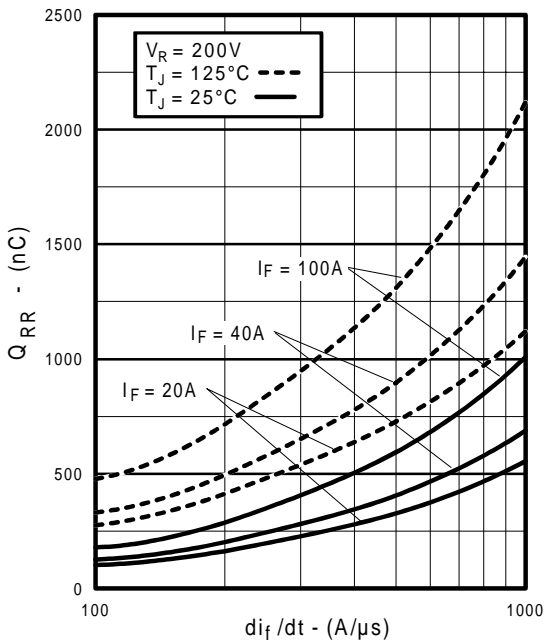

Fig. 7 - Typical Stored Charge vs. di_f/dt , (per Leg)

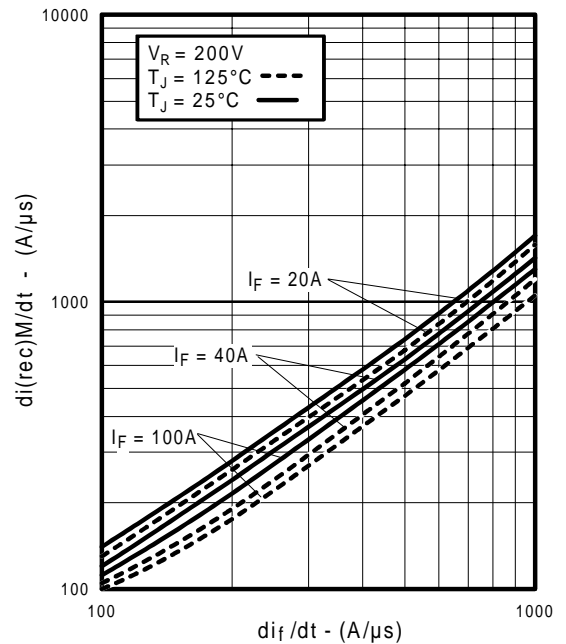

Fig. 8 - Typical $di(rec)M/dt$ vs. di_f/dt , (per Leg)

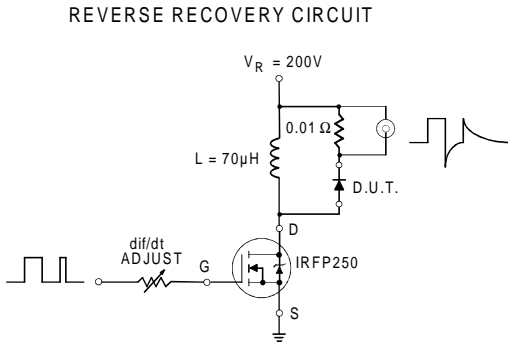
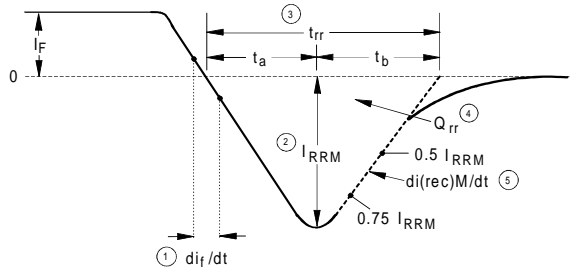

Fig. 9 - Reverse Recovery Parameter Test Circuit



1. di_f/dt - Rate of change of current through zero crossing
2. I_{RRM} - Peak reverse recovery current
3. t_{rr} - Reverse recovery time measured from zero crossing point of negative going I_F to point where a line passing through $0.75 I_{RRM}$ and $0.5 I_{RRM}$ extrapolated to zero current
4. Q_{rr} - Area under curve defined by t_{rr} and I_{RRM}
5. $di_{(rec)M}/dt$ - Peak rate of change of current during t_b portion of t_{rr}

$$Q_{rr} = \frac{t_{rr} \times I_{RRM}}{2}$$

Fig. 10 - Reverse Recovery Waveform and Definitions

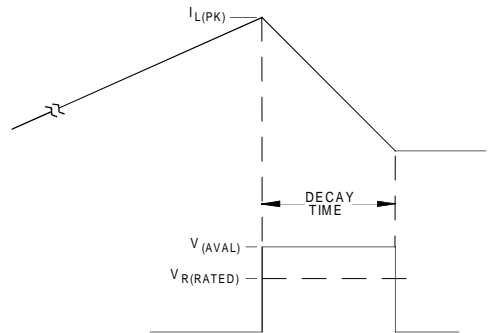
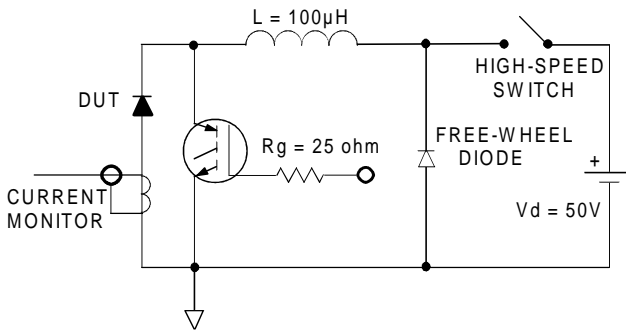

Fig. 11 - Avalanche Test Circuit and Waveforms