

# International IOR Rectifier

## REPETITIVE AVALANCHE AND $dv/dt$ RATED HEXFET<sup>®</sup> TRANSISTORS THRU-HOLE (TO-204AA/AE)

## IRFAF50 900V, N-CHANNEL

### Product Summary

Part Number	BVDSS	RDS(on)	Id
IRFAF50	900V	1.6Ω	6.2A

The HEXFET<sup>®</sup> technology is the key to International Rectifier's advanced line of power MOSFET transistors. The efficient geometry and unique processing of this latest "State of the Art" design achieves: very low on-state resistance combined with high transconductance; superior reverse energy and diode recovery  $dv/dt$  capability.

The HEXFET transistors also feature all of the well established advantages of MOSFETs such as voltage control, very fast switching, ease of paralleling and temperature stability of the electrical parameters.

They are well suited for applications such as switching power supplies, motor controls, inverters, choppers, audio amplifiers and high energy pulse circuits.



TO-3

### Features:

- Repetitive Avalanche Ratings
- Dynamic  $dv/dt$  Rating
- Hermetically Sealed
- Simple Drive Requirements
- Ease of Paralleling

### Absolute Maximum Ratings

	Parameter		Units
$I_D$ @ $V_{GS} = 0V, T_C = 25^\circ C$	Continuous Drain Current	6.2	A
$I_D$ @ $V_{GS} = 0V, T_C = 100^\circ C$	Continuous Drain Current	4.0	
$I_{DM}$	Pulsed Drain Current ①	25	
$P_D$ @ $T_C = 25^\circ C$	Max. Power Dissipation	150	W
	Linear Derating Factor	1.2	W/ $^\circ C$
$V_{GS}$	Gate-to-Source Voltage	$\pm 20$	V
EAS	Single Pulse Avalanche Energy ②	870	mJ
$I_{AR}$	Avalanche Current ①	6.2	A
E <sub>AR</sub>	Repetitive Avalanche Energy ①	15	mJ
$dv/dt$	Peak Diode Recovery $dv/dt$ ③	1.5	V/ns
$T_J$	Operating Junction	-55 to 150	$^\circ C$
$T_{STG}$	Storage Temperature Range		
	Lead Temperature	300 (0.063 in. (1.6mm) from case for 10s)	
	Weight	11.5(typical)	g



**Electrical Characteristics @ T<sub>j</sub> = 25°C (Unless Otherwise Specified)**

	Parameter	Min	Typ	Max	Units	Test Conditions
BV <sub>DSS</sub>	Drain-to-Source Breakdown Voltage	900	—	—	V	V <sub>GS</sub> = 0V, I <sub>D</sub> = 1.0mA
ΔBV <sub>DSS</sub> /ΔT <sub>J</sub>	Temperature Coefficient of Breakdown Voltage	—	1.2	—	V/°C	Reference to 25°C, I <sub>D</sub> = 1.0mA
R <sub>Ds(on)</sub>	Static Drain-to-Source On-State Resistance	—	—	1.6	Ω	V <sub>GS</sub> = 10V, I <sub>D</sub> = 4.0A ④
		—	—	1.85		V <sub>GS</sub> = 10V, I <sub>D</sub> = 6.2A ④
V <sub>GS(th)</sub>	Gate Threshold Voltage	2.0	—	4.0	V	V <sub>DS</sub> = V <sub>GS</sub> , I <sub>D</sub> = 250μA
g <sub>fs</sub>	Forward Transconductance	4.9	—	—	S (Ω)	V <sub>DS</sub> > 15V, I <sub>DS</sub> = 4.0A ④
I <sub>DSS</sub>	Zero Gate Voltage Drain Current	—	—	25	μA	V <sub>DS</sub> = 720V, V <sub>GS</sub> = 0V
		—	—	250		V <sub>DS</sub> = 720V V <sub>GS</sub> = 0V, T <sub>J</sub> = 125°C
I <sub>GSS</sub>	Gate-to-Source Leakage Forward	—	—	100	nA	V <sub>GS</sub> = 20V
I <sub>GSS</sub>	Gate-to-Source Leakage Reverse	—	—	-100	nA	V <sub>GS</sub> = -20V
Total Gate Charge		80	—	180	nC	V <sub>GS</sub> = 10V, I <sub>D</sub> = 6.2A V <sub>DS</sub> = 450V
Q <sub>gs</sub>	Gate-to-Source Charge	7.5	—	17		
Q <sub>gd</sub>	Gate-to-Drain ('Miller') Charge	48	—	110		
t <sub>d(on)</sub>	Turn-On Delay Time	—	—	33		V <sub>DD</sub> = 400V*, I <sub>D</sub> = 6.2A, R <sub>G</sub> = 2.35Ω
t <sub>r</sub>	Rise Time	—	—	66		
t <sub>d(off)</sub>	Turn-Off Delay Time	—	—	200		
t <sub>f</sub>	Fall Time	—	—	57		
L <sub>S</sub> + L <sub>D</sub>	Total Inductance	—	6.1	—		
C <sub>iss</sub>	Input Capacitance	—	2700	—	pF	V <sub>GS</sub> = 0V, V <sub>DS</sub> = 25V f = 1.0MHz
C <sub>oss</sub>	Output Capacitance	—	500	—		
C <sub>rss</sub>	Reverse Transfer Capacitance	—	200	—		

\*Equipment Limitation

**Source-Drain Diode Ratings and Characteristics**

	Parameter	Min	Typ	Max	Units	Test Conditions
I <sub>S</sub>	Continuous Source Current (Body Diode)	—	—	6.2	A	
I <sub>SM</sub>	Pulse Source Current (Body Diode) ①	—	—	25		
V <sub>SD</sub>	Diode Forward Voltage	—	—	1.8	V	T <sub>j</sub> = 25°C, I <sub>S</sub> = 6.2A, V <sub>GS</sub> = 0V ④
t <sub>rr</sub>	Reverse Recovery Time	—	—	1500	nS	T <sub>j</sub> = 25°C, I <sub>F</sub> = 6.2A, di/dt ≤ 100A/μs
Q <sub>RR</sub>	Reverse Recovery Charge	—	—	11	μC	V <sub>DD</sub> ≤ 50V ④
t <sub>on</sub>	Forward Turn-On Time	Intrinsic turn-on time is negligible. Turn-on speed is substantially controlled by L <sub>S</sub> + L <sub>D</sub> .				

**Thermal Resistance**

	Parameter	Min	Typ	Max	Units	Test Conditions
R <sub>thJC</sub>	Junction to Case	—	—	0.83	°C/W	Typical socket mount
R <sub>thJA</sub>	Junction to Ambient	—	—	30		

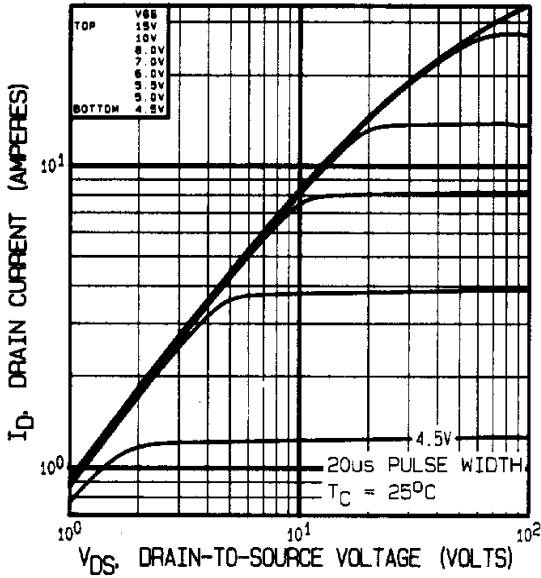

**Fig 1.** Typical Output Characteristics

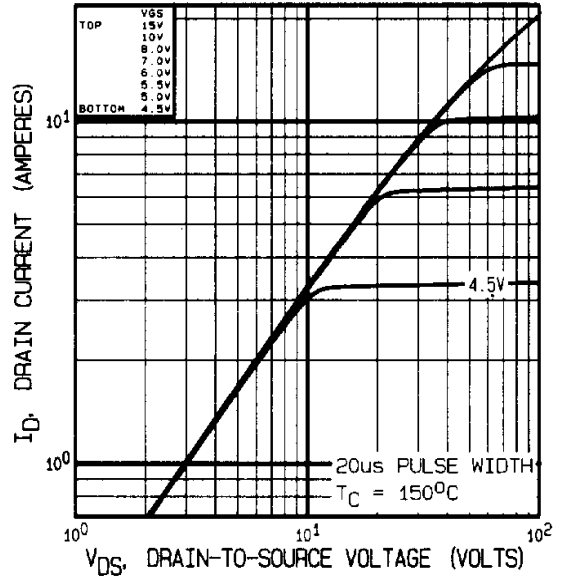

**Fig 2.** Typical Output Characteristics

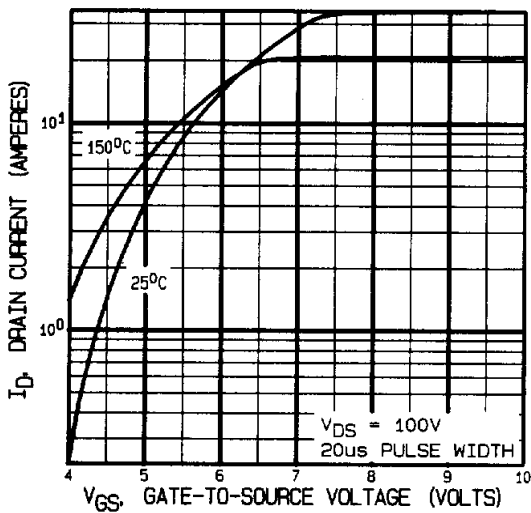

**Fig 3.** Typical Transfer Characteristics

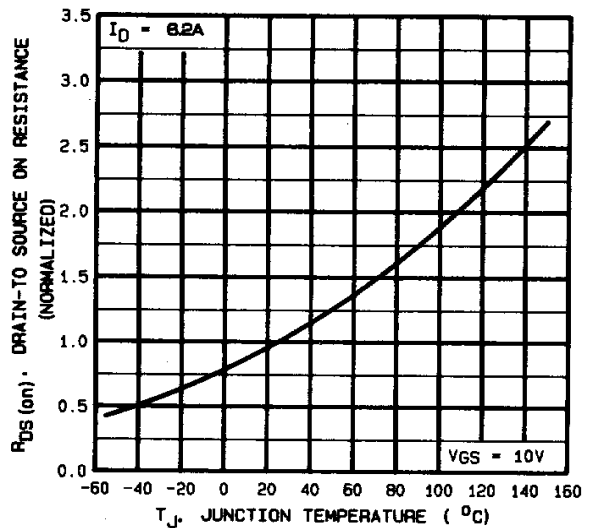

**Fig 4.** Normalized On-Resistance Vs. Temperature

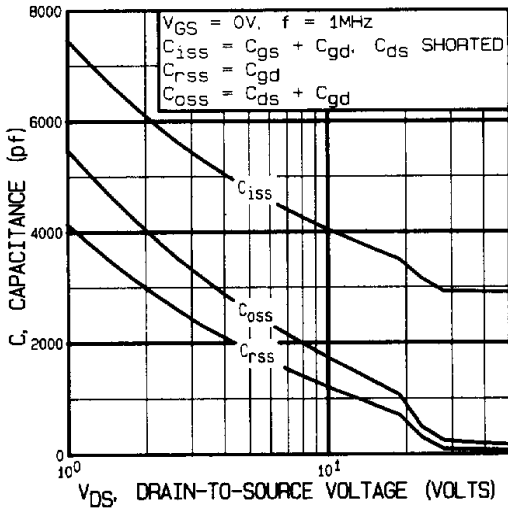

**Fig 5.** Typical Capacitance Vs. Drain-to-Source Voltage

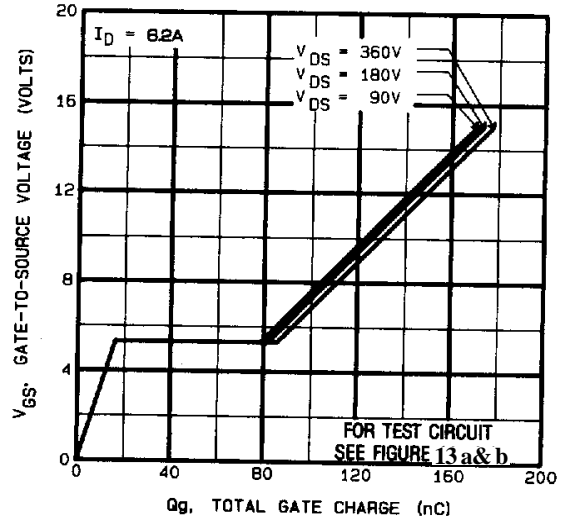

**Fig 6.** Typical Gate Charge Vs. Gate-to-Source Voltage

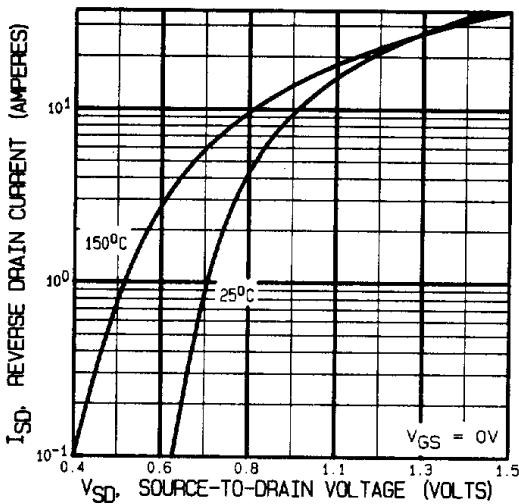

**Fig 7.** Typical Source-Drain Diode Forward Voltage

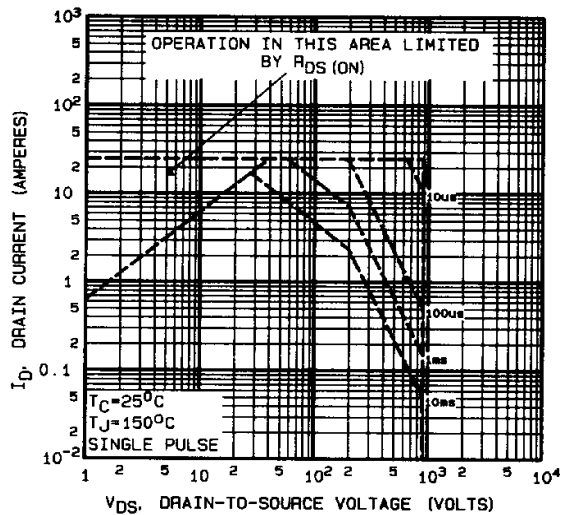

**Fig 8.** Maximum Safe Operating Area

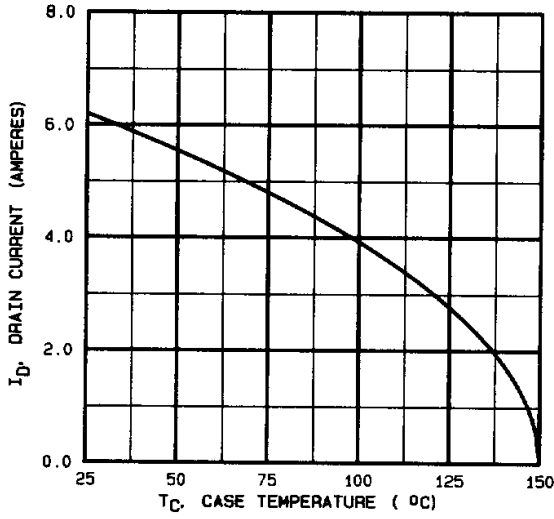

Fig 9. Maximum Drain Current Vs. Case Temperature

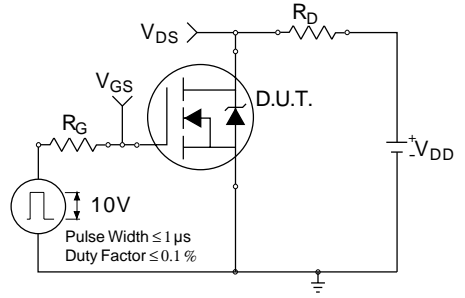

Fig 10a. Switching Time Test Circuit

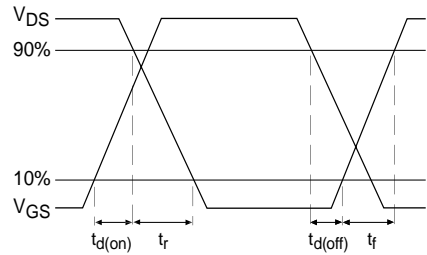

Fig 10b. Switching Time Waveforms

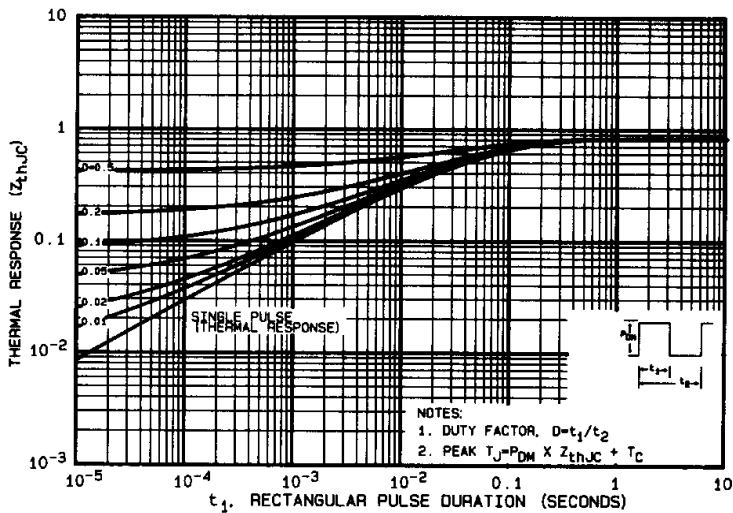

Fig 11. Maximum Effective Transient Thermal Impedance, Junction-to-Case

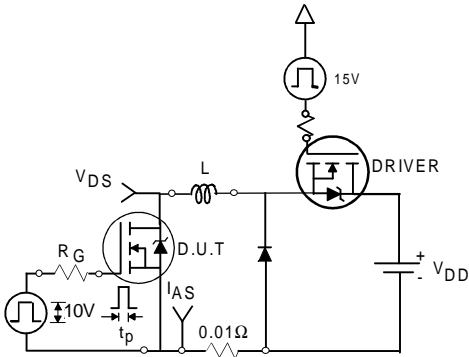

Fig 12a. Unclamped Inductive Test Circuit

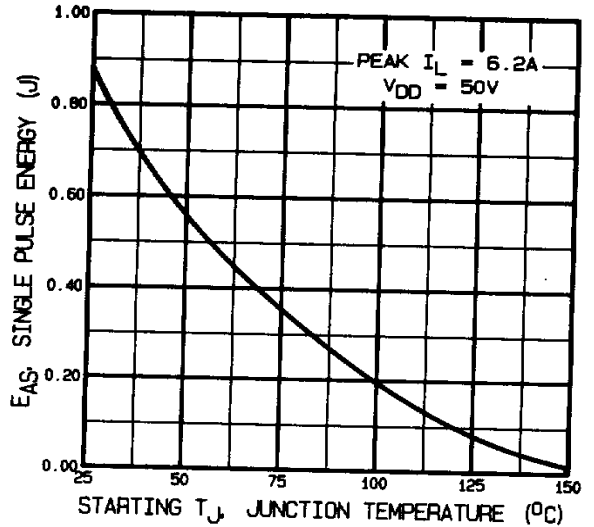

Fig 12c. Maximum Avalanche Energy Vs. Drain Current

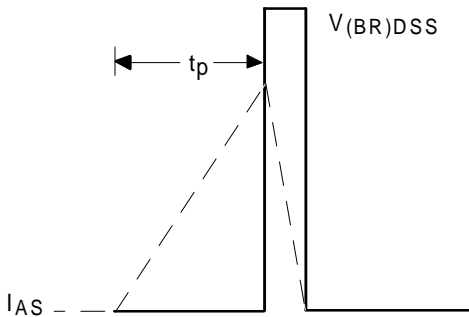

Fig 12b. Unclamped Inductive Waveforms

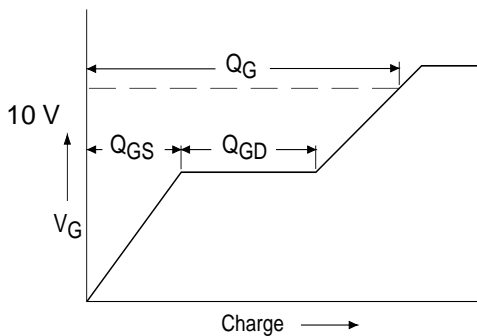

Fig 13a. Basic Gate Charge Waveform

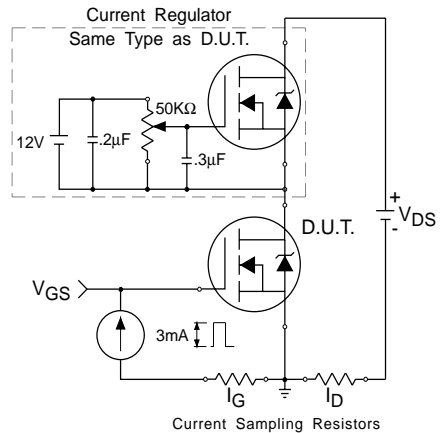
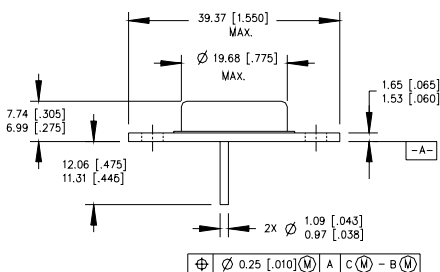

Fig 13b. Gate Charge Test Circuit

**Foot Notes:**

- ① Repetitive Rating; Pulse width limited by maximum junction temperature.
- ②  $V_{DD} = 50V$ , starting  $T_J = 25^{\circ}C$ ,  $L \geq 43mH$ , Peak  $I_L = 6.2A$ ,
- ③  $I_{SD} \leq 6.2A$ ,  $di/dt \leq 130A/\mu s$ ,  
 $V_{DD} \leq 900V$ ,  $T_J \leq 150^{\circ}C$   
Suggested  $R_G = 2.35 \Omega$
- ④ Pulse width  $\leq 300 \mu s$ ; Duty Cycle  $\leq 2\%$

**Case Outline and Dimensions —TO-204AA (Modified TO-3)**



PIN ASSIGNMENTS

HEXFET	SCHOTTKY	IGBT
1 - SOURCE	1 - ANODE 1	1 - GATE
2 - GATE	2 - ANODE 2	2 - EMITTER
3 - DRAIN (CASE)	3 - COMMON CATHODE (CASE)	3 - COLLECTOR (CASE)

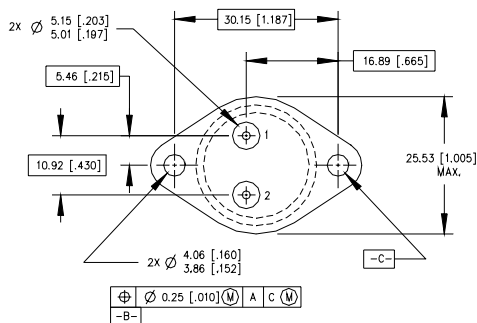

NOTES:

1. DIMENSIONING & TOLERANCING PER ANSI Y14.5M-1982.
2. CONTROLLING DIMENSION : INCH.
3. DIMENSIONS ARE SHOWN IN MILLIMETERS [INCHES].
4. OUTLINE CONFORMS TO JEDEC OUTLINE TO-204-AA.