

FAN5232

Adjustable PWM Buck Controller for LCD PCs

Features

- Three outputs: Adjustable Buck, 3.3V-Always, 5V-Always
- Adjustable synchronous switcher, 5V – 80% V_{in}
- 1% internal reference precision
- Current mode with voltage feed-forward
- Precision current limit option
- Charge pump works at all loads
- No shoot-through current
- Independent shutdown pins for ACPI
- Power Good, input UVLO, output OV
- 5.6V to 24V input voltage range

Applications

- LCD PCs
- Notebook PCs and PDAs
- Hand-held portable instruments

Description

The FAN5232 is a high efficiency and high precision DC/DC controller for PCs. It has a synchronous switcher whose output can be adjusted from 5V up to 80% of V_{in} . It also has two linear regulators for standby, 3.3V and 5V. The PWM utilizes both input and output voltage feedback in a current-mode control, allowing for fast and stable loop response over a wide range of input and output variations. Synchronous switching provides best efficiency over a wide range of loads. Current sense based on MOSFET $R_{DS,on}$ gives maximum efficiency, while also permitting use of an optional sense resistor for high precision.

The FAN5232 is available in a 14 pin TSSOP package.

Block Diagram

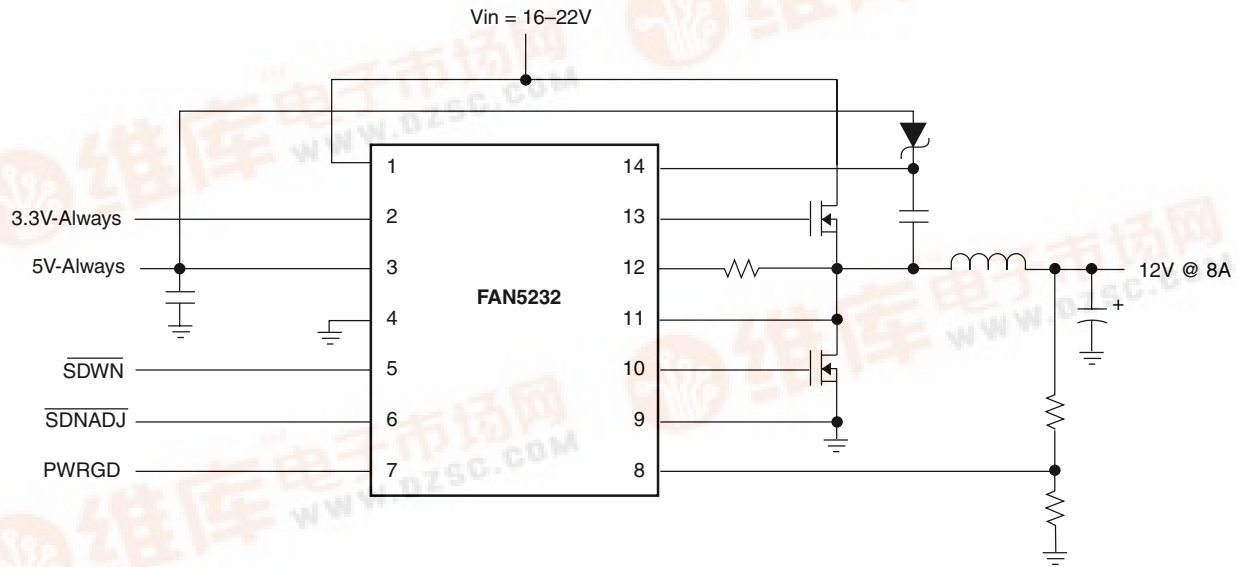

Pin Assignments

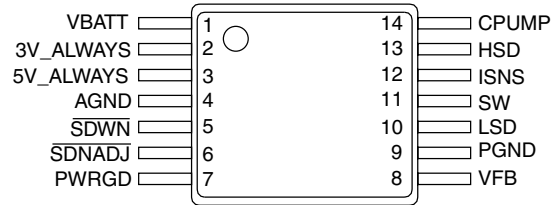

Pin Description

Pin Number	Pin Name	Pin Function Description
1	VBATT	Battery Voltage. Battery voltage sensor.
2	3V_ALWAYS	3.3V-ALWAYS Linear Regulator. Total load current on pins 2 and 3 together must not exceed 50mA.
3	5V_ALWAYS	5V-ALWAYS Linear Regulator. Total load current on pins 2 and 3 together must not exceed 50mA.
4	AGND	Analog Ground.
5	$\overline{\text{SDWN}}$	IC Shutdown. Puts entire chip into shutdown. OFF=0. ON=1.
6	$\overline{\text{SDNADJ}}$	Shutdown and Softstart for the Switcher. OFF=0. ON=1.
7	PWRGD	Switcher Output OK. An open collector output that will be low if the switcher output is out of spec.
8	VFBSW	Voltage Feedback for the Switcher.
9	PGND	Ground for the Switcher. Connect by the shortest possible path to the source of the low side MOSFET.
10	LSD	Low Side FET Driver for the Switcher. Connect this pin through a resistor to the gate of an N-channel MOSFET.
11	SW	High Side FET Source and Low Side FET Drain Switching Node.
12	ISNS	Current Feedback for the Switcher. Connect by the shortest possible path to a resistor connected to the drain of the low side MOSFET.
13	HSD	High Side FET Driver for the Switcher. Connect this pin through a resistor to the gate of an N-channel MOSFET.
14	CPUMP	Charge Pump for the Switcher. Generates gate drive voltage for the high-side MOSFET.

Absolute Maximum Ratings¹

Parameter	Conditions	Min.	Typ.	Max.	Units
VBATT Pin		-0.3		29	V
PHASE, IFB, $\overline{\text{SDWN}}$ Pins		-5		29	V
CPUMP, HSD Pins		-0.3		34	V
All Other Pins		-0.3		6.5	V
Thermal Resistance, θ_{J-A} θ_{J-C}			100 32		$^{\circ}\text{C}/\text{W}$ $^{\circ}\text{C}/\text{W}$
Junction Temperature				150	$^{\circ}\text{C}$
Storage Temperature		-65		150	$^{\circ}\text{C}$
Lead Temperature, Soldering 10 sec.				300	$^{\circ}\text{C}$

Note:

- Functional operation under any of these conditions is NOT implied. Performance and reliability are guaranteed only if Operating Conditions are not exceeded.

Recommended Operating Conditions

Parameter	Conditions	Min.	Typ.	Max.	Units
VBATT Voltage		5.6		24	V
Ambient Temperature		-20		85	°C

Electrical Specifications

($V_{BATT} = 16V$, $T_A = -20$ to $85^\circ C$, circuit of Figure 1, unless otherwise specified.)

Parameter	Conditions	Min.	Typ.	Max.	Units
Supply					
V_{CC} Input Quiescent Current	H/LSD Open			1.4	mA
	Stand-by			60	μA
	Shut-down			10	μA
V_{CC} Input UVLO Threshold	Rising	4.3	4.5	5.1	V
	Falling	4.0	4.3	4.7	
Switcher					
Output Voltage Precision, VFB	$0.1 \leq I \leq 5.5A$, $7.2 \leq V_{BATT} \leq 24V$	4.900	5	5.100	V
	$I \leq 100mA$, $5.6 \leq V_{BATT} \leq 24V$	4.900	5	5.100	
Oscillator Frequency, f_{OSC}		255	300	345	KHz
Gate Drive On-Resistance for all Sources and HSD Sinks			6	12	Ω
Gate Drive On Resistance for LSD Sink			1.5	8	Ω
HSD On Output, $V_{CPUMP}-V_{GS}$	$I = 10\mu A$			100	mV
HSD Off Output, V_{GS}	$I = -10\mu A$			100	mV
LSD On Output, $V_{5V-Always}-V_{GS}$	$I = 10\mu A$			100	mV
LSD Off Output, V_{GS}	$I = -10\mu A$			100	mV
Ramp Amplitude, pk-pk			2		V
Ramp Offset			0.5		V
Ramp Gain from VBATT			125		mV/V
Error Amplifier GBW			3		MHz
Current Limit Threshold	$R3 = 1K\Omega$	135	150	165	mV
Over Voltage Threshold	2 μs delay	110	115	120	% V_O
Under Voltage Threshold	2 μs delay	70	75	80	% V_O
Max Duty Cycle		80			%
Min HSD On-time			200		nsec
VFBSW, ISNS Input Leakage Current			100	200	nA
SDN/SS Full On Voltage Min.		4.2			V
SDN/SS Full Off Voltage Max.				800	mV
5V and 3.3V Always					
Linear Regulator Accuracy	$5.6V \leq V_{BATT} \leq 22V$, $0 \leq I_{LOAD} \leq 50mA$	-3.3		2	%
Rated Output Current	$I_{3.3} + I_5$			50	mA
Overcurrent Limit	2 μs delay	100		180	mA
Undervoltage Threshold	2 μs delay	70	75	80	%

Electrical Specifications (Continued)

($V_{BATT} = 16V$, $T_A = -20$ to $85^\circ C$, circuit of Figure 1, unless otherwise specified.)

Parameter	Conditions	Min.	Typ.	Max.	Units
Control and Signal Functions					
Control Logic Low				600	mV
Control Logic High		2			V
Softstart Current		3	5	7	μA
Over-temperature Shutdown			150		$^\circ C$
Over-temperature Hysteresis			25		$^\circ C$
PWRGD Threshold		-14	-12	-9	$\%V_O$
PWRGD Saturation Voltage	$I_{sink} = 4mA$			400	mV
PWRGD Leakage Current	$V_{CC} = 5.5V$			1	μA
PWRGD Pulse Width for Trip	Low \rightarrow High, High \rightarrow Low	5		10	μsec

Application Circuit

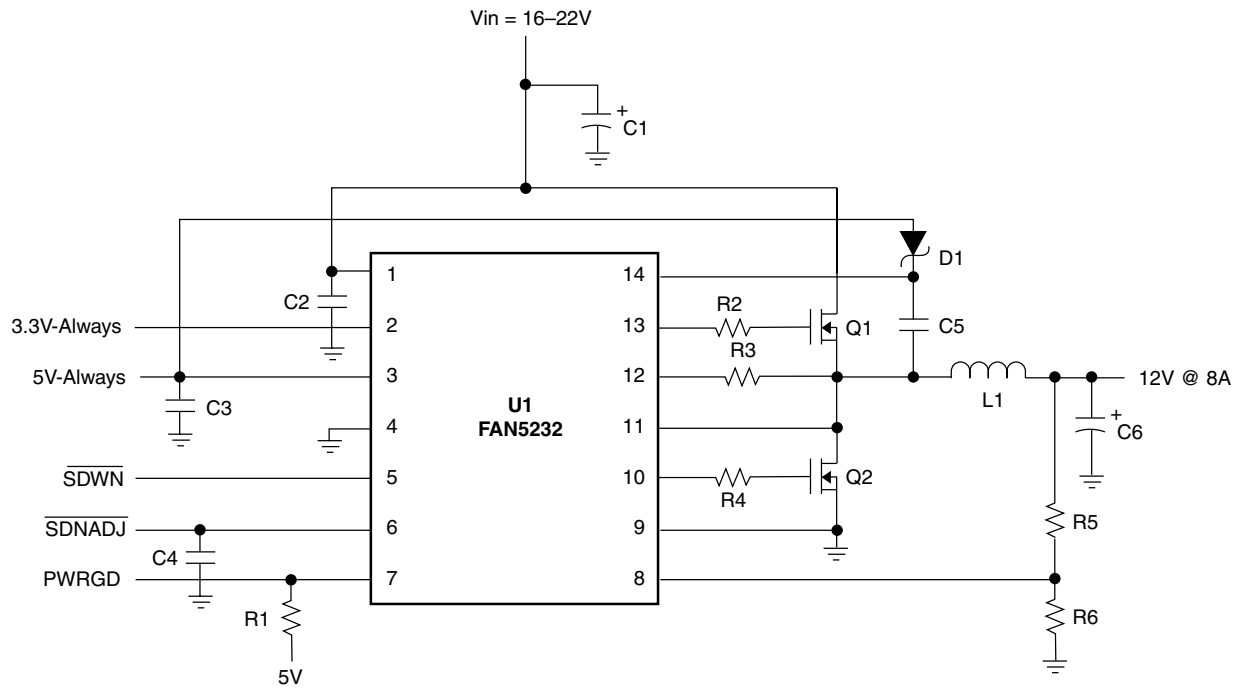

Figure 1. Application Circuit for LCD PC Main Power

Table 1. RC5232 Application Bill of Materials

Reference	Manufacturer, Part #	Quantity	Description	Comments
C1	SANYO 25SV47M	1	47 μ F, 25V	OSCON, $I_{rms} = 3.5A$
C2-5	Any	4	100nF, 50V	Ceramic
C6	AVX TPSE227M016#0100	1	220 μ F, 16V	Tantalum, ESR=100m Ω
R1	Any	1	10K Ω , 1%	
R2, R4	Any	2	4.7 Ω , 1%	
R3, R5	Any	2	1K Ω , 1%	
R6	Any	1	715 Ω , 1%	
D1	Fairchild MBR0540L	1	500mA, 40V Schottky	
L1	Coiltronics UP2B-1R5	1	1.5 μ H, 8.3A	R < 8m Ω
Q1	Fairchild FDS6690A	1	30V N-channel MOSFET	R = 20m Ω @ $V_{GS} = 4.5V$
Q2	Fairchild FDS6680S	1	30V N-channel MOSFET with Integrated Schottky	R = 17m Ω @ $V_{GS} = 4.5V$
U1	Fairchild FAN5232	1	Controller	

Application Information

Overview

The FAN5232 is a high efficiency and high precision DC/DC controller for LCD PCs and portable applications. It provides a switcher controller capable of generating a voltage between 5V to 80% of V_{in} , and a 5V and a 3.3V linear regulator for standby applications. The controller has a power good output and an enable/soft start to permit proper system sequencing.

Initialization

The FAN5232 automatically initializes upon receipt of input power. The Power-on Reset (POR) function continually monitors the input supply voltage on the V_{CC} pin and initiates soft start operation after the input supply voltage exceeds 4.5V. Should this voltage drop below 4.0V, POR disables the chip.

Soft Start

When soft start is initiated by POR, and if the \overline{SDWN} pin is not held low, the voltage on the $SDNADJ$ pin begins ramping up, with the rate of rise set by the external capacitor on the pin. Below 700mV, the output is off. Between 700mV and 1.6V, the output is allowed to linearly ramp up. Above 1.6V, the output is fully enabled, and regulates.

Shutdown

There are two separate shutdown pins to provide output power control – \overline{SDWN} , and $SDNADJ$. Taking the \overline{SDNADJ} pin low will disable the switcher output and reset the output's internal latches for short circuit, under-voltage and over-voltage. Taking the \overline{SDWN} pin low puts the entire chip in shutdown. Each of the SDN pins has an internal pull-up.

Switcher Architecture

Overview

The switcher output of the FAN5232 is generated from the unregulated input (battery) voltage using a synchronous buck converter. Both high-side and low-side MOSFETs are N-channel.

The converter has pins for current sensing using the low-side MOSFET $R_{DS,on}$; a pin for voltage-sense feedback; a pin that enables the converter and permits soft-start; a power good pin; and a pin for generating the boost voltage to drive the high-side MOSFET.

Loop Compensation

The switcher regulator control loop of the FAN5232 is current-mode with voltage feed-forward. It uses voltage feed-forward to guarantee loop rejection of input voltage variation: the ramp amplitude is varied as a function of the input voltage. Compensation of the control loop is done entirely internally using current-mode compensation. This scheme allows the bandwidth and phase margin to be almost independent of output capacitance and capacitors' ESR. Use of a current sense resistor other than the recommended 1K Ω may affect the converter's stability.

Current Sensing

Current sensing is done by measuring the voltage across the low side MOSFET 50nsec after it is turned on. This value is then held for current feedback and over-current limit. The gain is set by an external resistor from the drain to the ISNS pin, which is normally set to be 1K Ω .

Current Limit

The converter senses the voltage across its low-side MOSFET to determine when to enter current limit. If output current in excess of the current limit threshold is measured, the converter enters pulse skip mode with I_{out} equal to the over-current (OC) limit. If this situation persists for 8 clock cycles then the regulator is latched off (HSD and LSD off). This is the likely scenario in case of a "soft" short. If the short is "hard", it will instantly trigger the under-voltage protection, which again will latch the regulator off (HSD and LSD off) after a 2 μ sec delay.

Selection of a current-limit set resistor must include the tolerance of the current-limit trip point, the MOSFET resistance and temperature coefficient, and the ripple current, in addition to the maximum output current.

Example: Maximum DC output current on the 12V is 8A, the MOSFET $R_{DS,on}$ is 17m Ω , and the inductor is 4.7 μ H at a current of 8A. Because of the low $R_{DS,on}$, the low-side MOSFET will have a maximum temperature (ambient + self-heating) of only 75 $^{\circ}$ C, at which its $R_{DS,on}$ increases to 24m Ω .

Peak current is DC output current plus peak ripple current:

$$I_{pk} \approx I_{DC} + \frac{TV_O \cdot (V_{in} - V_o)}{2 \cdot L \cdot V_{in}}$$

$$= 8A + \frac{4\mu s \cdot 12V \cdot (19V - 12V)}{2 \cdot 4.7\mu H \cdot 12V} = 11A$$

where T is the maximum period, V_O is output voltage, V_{in} is input voltage, and L is the inductance. This current generates a voltage on the low-side MOSFET of 11A \cdot 24m Ω = 254mV. The current limit threshold is typically 150mV (worst-case 135mV) with $R_2 = 1K\Omega$, and so this value must be decreased to (135/254) \cdot 1K Ω = 531 Ω .

Precision Current Limit

Precision current limiting can be achieved by placing a discrete sense resistor between the source of the low-side MOSFET and ground. Sensing is then accomplished with the 1K Ω resistor between the sense resistor and the IFBSW pin, as shown in Figure 2. In this case, current limit accuracy is set by the tolerance of the IC, $\pm 10\%$.

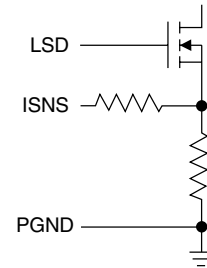

Figure 2. Precision Current Sensing

Softstart

Softstart of the switcher is accomplished by means of an external capacitor between pins \overline{SDNADJ} and ground.

Overvoltage Protection (Soft Crowbar)

When the output voltage of the switcher exceeds approximately 115% of nominal, it enters into over-voltage (OV) protection, with the goal of protecting the load from damage. During operation, severe load dump or a short of an upper MOSFET can cause the output voltage to increase significantly over normal operation range. When the output exceeds the over-voltage threshold of 115%, the over-voltage comparator forces the lower gate driver high and turns the lower MOSFET on. This will pull down the output voltage and eventually may blow the battery fuse. As soon as output voltage drops below the threshold, the OVP comparator is disengaged.

This OVP scheme provides a soft crowbar function (bang-bang control followed by blow of the fuse), which helps to tackle severe load transients and does not invert the output voltage when activated – common problem for OVP schemes with a latch. The prevention of the output inversion saves the use of a Schottky diode across the load.

Undervoltage Protection

When the output voltage of the switcher falls below 75% of nominal value, after a 2 μ sec delay it goes into under-voltage protection. In under-voltage protection, the high and low side MOSFETs are turned off. Once under-voltage protection is triggered, it remains on until power is recycled.

5V/3.3V-ALWAYS Operation

The 5V-ALWAYS supply is generated from the on-chip linear regulator off the input supply voltage. The 3.3V-ALWAYS is generated from a linear regulator attached internally to the 5V-ALWAYS.

The purpose of these two supplies -whose combined current is specified to never exceed 50mA- is to provide power to the system micro-controller (8051 class) as well as a few other ICs needing a stand-by power. The micro-controller as well as the other IC's discussed here are migrating from 5V to 3.3V power at different times and we expect that some "legacy" devices will continue to need 5V indefinitely.

5V/3.3V-ALWAYS Protections

The two internal linear regulators are current limit and undervoltage protected. Once protection is triggered **all** outputs go off until power is recycled.

ALWAYS mode of Operation

If it is desired that the ALWAYS voltages are always ON then the $\overline{\text{SDWN}}$ pin must be connected to V_{CC} permanently. This way the ALWAYS regulator comes up as soon as there is power while the state of the switcher can be controlled via the $\overline{\text{SDNADJ}}$ pin.

Component Selection

Switcher MOSFET Selection

The application circuit shown in Figure 1 is designed to run with an input voltage operating range of 16–22V. This input range helps determine the selection of the MOSFETs for the switcher, since the high-side MOSFET can be on as much as $(V_{out} / V_{in}) = 12V / 16V = 75\%$ of the time, and the low-side MOSFET as much as $1 - (V_{out} / V_{in}) = 1 - (12V / 22V) = 45\%$ of the time.

The MOSFETs have maximum duty cycles greater than 45%. Thus, it is necessary to size both approximately the same.

Switcher Schottky Selection

In the application shown in Figure 1, the use of a SynchFET eliminates the need of a Schottky diode for the synchronous buck. If SynchFETs are not used, selection of a schottky is determined by the maximum current at which the converter operates. Select a diode whose instantaneous Vf is less than 0.75V at the maximum output current. The schottky dissipates no power, because it is on for only a very small portion of the switching cycle.

Input Capacitor Selection

Input capacitor selection is determined by ripple current rating by the formula:

$$I_{rms} = I_{out} \sqrt{DC - DC^2}$$

where I_{out} is the output current of the converter, and DC is the duty cycle, $DC = V_{in} / V_{out}$. Capacitor ripple current rating is a function of temperature and switching frequency, and so the manufacturer should be contacted to find out the ripple current rating at the expected operational temperature and frequency.

Soft Start Capacitor selection

The recommended value of the soft start capacitor is 100nF. This will result in roughly 20msec turn on time. The general formula is:

$$C_{SS} = \frac{(I_{SS} \cdot T_{SS})}{1.125V}$$

Where I_{SS} is the soft start current (5μA), T_{SS} is the soft start delay (i.e. 20msec).

Control and Signal Circuitry

Power Good

Power Good is an open-collector signal, and is asserted when the outputs are greater than 88% of nominal for more than 2μsec. When PWRGD goes low it will stay low for at least 2μsec.

Fault Handling

The FAN5232 has a full suite of protection against faults. Consult Table 2 for an overview, and the individual sections for details.

Table 2. Fault Handling

Fault Condition	Switcher	3V- and 5V-Always
OC Switcher	Latch off	No Change
OC Always	No Change	Ramp Down till UV
UV Switcher	Latch off after 2μsec	No Change
UV Always	No Change	Latch off after 2μsec
UV V_{CC}	Off	Off

Mechanical Dimensions

14-Lead TSSOP

Symbol	Inches		Millimeters		Notes
	Min.	Max.	Min.	Max.	
A	—	.047	—	1.20	
A1	.002	.006	0.05	0.15	
A2	.031	.041	0.80	1.05	
B	.007	.011	0.17	0.27	5
C	.004	.008	0.09	0.20	5
D	.252	.260	6.40	6.60	2, 4
H	.252 BSC		6.40 BSC		
E	.169	.177	4.30	4.50	
e	.026 BSC		0.65 BSC		
L	.018	.030	0.45	0.75	3
N	14		14		6
α	0°	8°	0°	8°	
ccc	—	.004	—	0.10	

Notes:

1. Dimensioning and tolerancing per ANSI Y14.5M-1982.
2. "D" and "E1" do not include mold flash. Mold flash or protrusions shall not exceed .010 inch (0.25mm).
3. "L" is the length of terminal for soldering to a substrate.
4. Terminal numbers are shown for reference only.
5. "B" & "C" dimensions include solder finish thickness.
6. Symbol "N" is the maximum number of terminals.

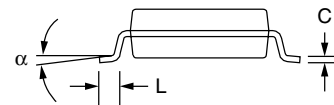
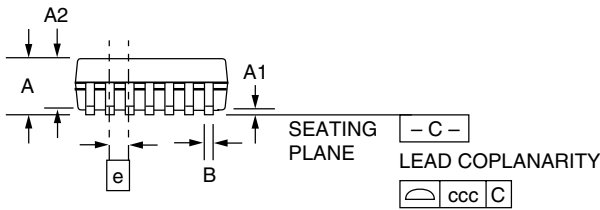
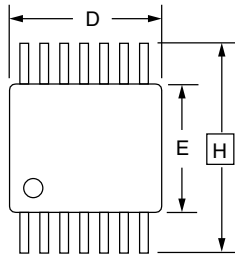

Ordering Information

Product Number	Package
FAN5232MTC	14 Lead TSSOP

DISCLAIMER

FAIRCHILD SEMICONDUCTOR RESERVES THE RIGHT TO MAKE CHANGES WITHOUT FURTHER NOTICE TO ANY PRODUCTS HEREIN TO IMPROVE RELIABILITY, FUNCTION OR DESIGN. FAIRCHILD DOES NOT ASSUME ANY LIABILITY ARISING OUT OF THE APPLICATION OR USE OF ANY PRODUCT OR CIRCUIT DESCRIBED HEREIN; NEITHER DOES IT CONVEY ANY LICENSE UNDER ITS PATENT RIGHTS, NOR THE RIGHTS OF OTHERS.

LIFE SUPPORT POLICY

FAIRCHILD'S PRODUCTS ARE NOT AUTHORIZED FOR USE AS CRITICAL COMPONENTS IN LIFE SUPPORT DEVICES OR SYSTEMS WITHOUT THE EXPRESS WRITTEN APPROVAL OF THE PRESIDENT OF FAIRCHILD SEMICONDUCTOR CORPORATION. As used herein:

1. Life support devices or systems are devices or systems which, (a) are intended for surgical implant into the body, or (b) support or sustain life, or (c) whose failure to perform when properly used in accordance with instructions for use provided in the labeling, can be reasonably expected to result in significant injury to the user.
2. A critical component is any component of a life support device or system whose failure to perform can be reasonably expected to cause the failure of the life support device or system, or to affect its safety or effectiveness.