

Ordering number:EN3075



# FC107

PNP Epitaxial Planar Silicon Composite Transistor

## Switching Applications

### Features

- On-chip bias resistors (R1=47kΩ, R2=47kΩ)
- Composite type with 2 transistors contained in the CP package currently in use, improving the mounting efficiency greatly.
- The FC107 is formed with two chips, being equivalent to the 2SA1341, placed in one package.
- Excellent in thermal equilibrium and pair capability.

### Electrical Connection

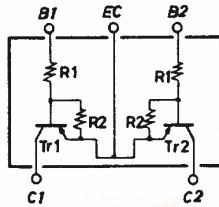

### Package Dimensions

unit:mm

2066

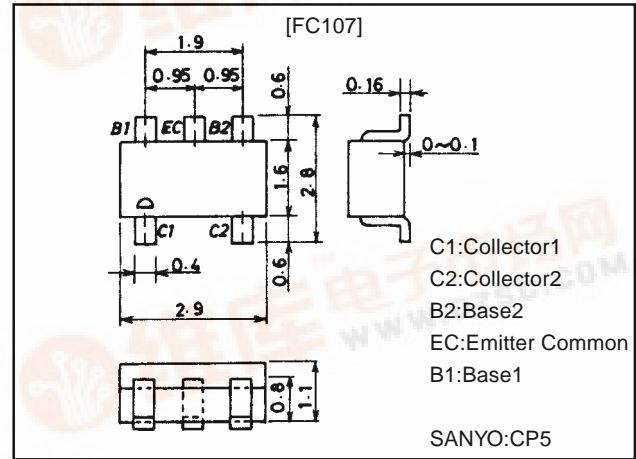

### Specifications

#### Absolute Maximum Ratings at Ta = 25°C

Parameter	Symbol	Conditions	Ratings	Unit
Collector-to-Base Voltage	V <sub>CB0</sub>		-50	V
Collector-to-Emitter Voltage	V <sub>CEO</sub>		-50	V
Emitter-to-Base Voltage	V <sub>EBO</sub>		-10	V
Collector Current	I <sub>C</sub>		-100	mA
Collector Current (Pulse)	I <sub>CP</sub>		-200	mA
Collector Dissipation	P <sub>C</sub>	1 unit	200	mW
Total Dissipation	P <sub>T</sub>		300	mW
Junction Temperature	T <sub>J</sub>		150	°C
Storage Temperature	T <sub>stg</sub>		-55 to+150	°C

#### Electrical Characteristics at Ta = 25°C

Parameter	Symbol	Conditions	Ratings			Unit
			min	typ	max	
Collector Cutoff Current	I <sub>CB0</sub>	V <sub>CB</sub> =-40V, I <sub>E</sub> =0			-0.1	μA
Collector Cutoff Current	I <sub>CEO</sub>	V <sub>CE</sub> =-40V, I <sub>B</sub> =0			-0.5	μA
Emitter Cutoff Current	I <sub>EBO</sub>	V <sub>EB</sub> =-5V, I <sub>C</sub> =0	-30	-53	-80	μA
DC Current Gain	h <sub>FE</sub>	V <sub>CE</sub> =-5V, I <sub>C</sub> =-5mA	50			
Gain-Bandwidth Product	f <sub>T</sub>	V <sub>CE</sub> =-10V, I <sub>C</sub> =-5mA		200		MHz
Output Capacitance	C <sub>ob</sub>	V <sub>CB</sub> =-10V, f=1MHz		5.1		pF
C-E Saturation Voltage	V <sub>CE(sat)</sub>	I <sub>C</sub> =-5mA, I <sub>B</sub> =-0.25mA		-0.1	-0.3	V
C-B Breakdown Voltage	V <sub>(BR)CBO</sub>	I <sub>C</sub> =-10μA, I <sub>E</sub> =0	-50			V
C-E Breakdown Voltage	V <sub>(BR)CEO</sub>	I <sub>C</sub> =-100μA, R <sub>BE</sub> =∞	-50			V
Input OFF-State Voltage	V <sub>I(off)</sub>	V <sub>CE</sub> =-5V, I <sub>C</sub> =-100μA	-0.8	-1.1	-1.5	V
Input ON-State Voltage	V <sub>I(on)</sub>	V <sub>CE</sub> =-0.2V, I <sub>C</sub> =-5mA	-1.0	-2.5	-5.0	V
Input Resistance	R <sub>1</sub>		32	47	62	kΩ
Resistance Ratio	R <sub>1/R2</sub>		0.9	1.0	1.1	

Note: The specifications shown above are for each individual transistor.

Marking:107

**SANYO Electric Co.,Ltd. Semiconductor Business Headquarters**

TOKYO OFFICE Tokyo Bldg., 1-10, 1 Chome, Ueno, Taito-ku, TOKYO, 110-8534 JAPAN



Sample Application Circuit

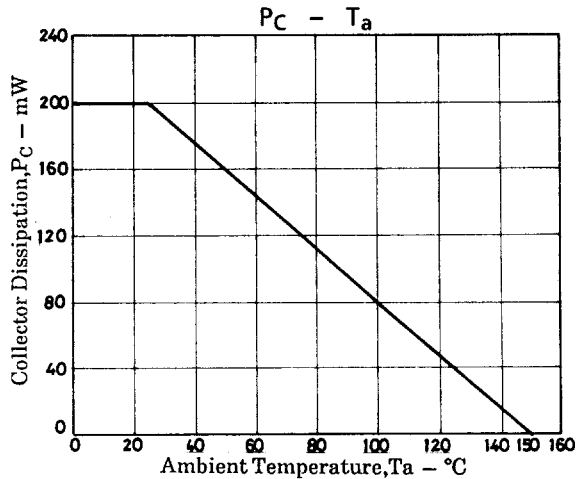
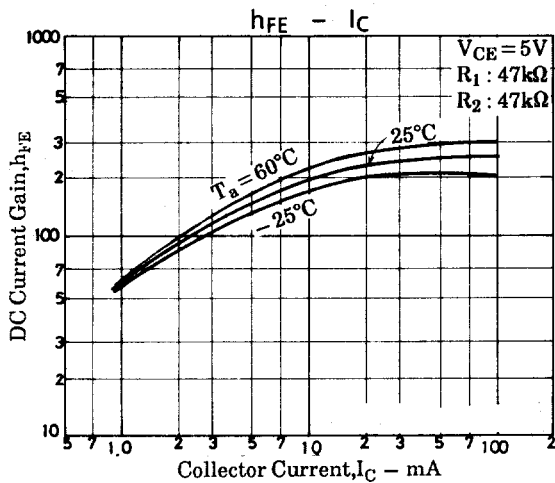
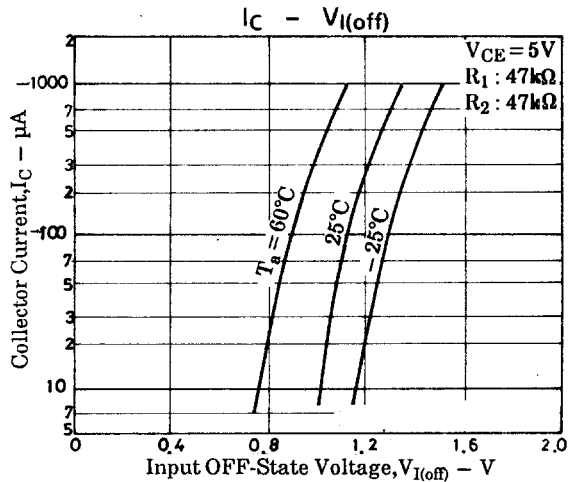
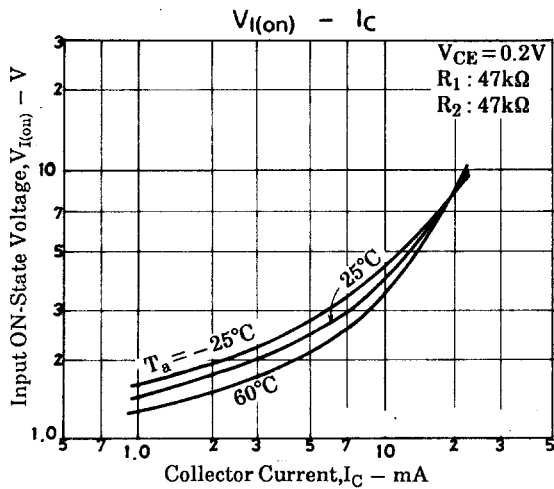
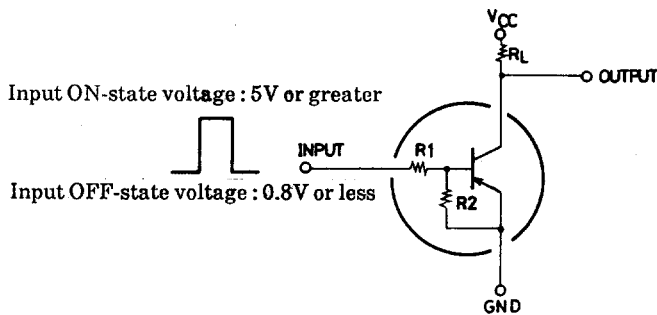

■ No products described or contained herein are intended for use in surgical implants, life-support systems, aerospace equipment, nuclear power control systems, vehicles, disaster/crime-prevention equipment and the like, the failure of which may directly or indirectly cause injury, death or property loss.

■ Anyone purchasing any products described or contained herein for an above-mentioned use shall:

- ① Accept full responsibility and indemnify and defend SANYO ELECTRIC CO., LTD., its affiliates, subsidiaries and distributors and all their officers and employees, jointly and severally, against any and all claims and litigation and all damages, cost and expenses associated with such use:
- ② Not impose any responsibility for any fault or negligence which may be cited in any such claim or litigation on SANYO ELECTRIC CO., LTD., its affiliates, subsidiaries and distributors or any of their officers and employees jointly or severally.

■ Information (including circuit diagrams and circuit parameters) herein is for example only; it is not guaranteed for volume production. SANYO believes information herein is accurate and reliable, but no guarantees are made or implied regarding its use or any infringements of intellectual property rights or other rights of third parties.