

SBD Type : FCH20A09

OUTLINE DRAWING

FEATURES

- *TO-220AB Case
- *Fully Molded
- *Dual Diodes – Cathode Common
- *Low Forward Voltage Drop
- *High Surge Capability
- *Tj=150 °C operation

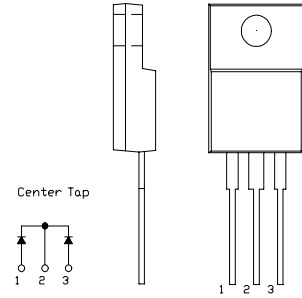

Maximum Ratings

Approx Net Weight: 1.75g

Rating	Symbol	FCH20A09			Unit
Repetitive Peak Reverse Voltage	V_{RRM}	90			V
Average Rectified Output Current	I_O	20	$T_c=121^{\circ}C$	50 Hz Full Sine Wave Resistive Load	A
RMS Forward Current	$I_{F(RMS)}$	22.2			A
Surge Forward Current	I_{FSM}	180	50Hz Full Sine Wave ,1cycle Non-repetitive		A
Operating JunctionTemperature Range	T_{jw}	-40 to +150			°C
Storage Temperature Range	T_{stg}	-40 to +150			°C
Mounting torque	F_{tor}	recommended torque = 0.5			N•m

Electrical • Thermal Characteristics

Characteristics	Symbol	Conditions	Min.	Typ.	Max.	Unit
Peak Reverse Current	I_{RM}	$T_j= 25^{\circ}C, V_{RM}= V_{RRM}$ per arm	-	-	1	mA
Peak Forward Voltage	V_{FM}	$T_j= 25^{\circ}C, I_{FM}= 10 A$ per arm	-	-	0.88	V
Thermal Resistance	$R_{th(j-c)}$	Junction to Case	-	-	1.5	°C/W
	$R_{th(c-f)}$	Cace to Fin	-	-	1.5	°C/W

FCH_A_OUTLINE DRAWING (Dimensions in mm)

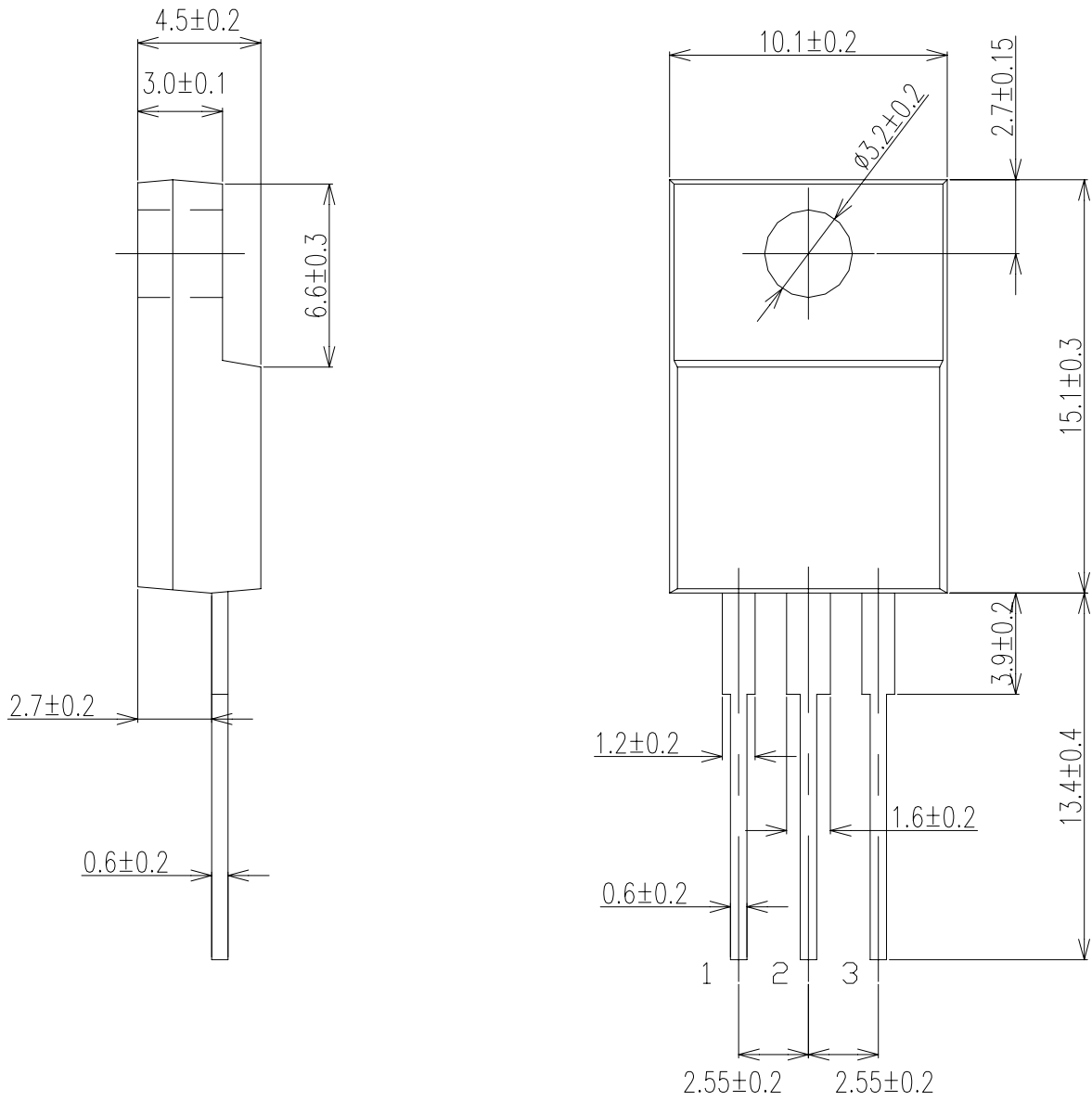

Center Tap

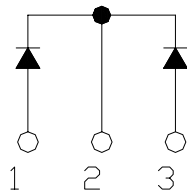

FORWARD CURRENT VS. VOLTAGE

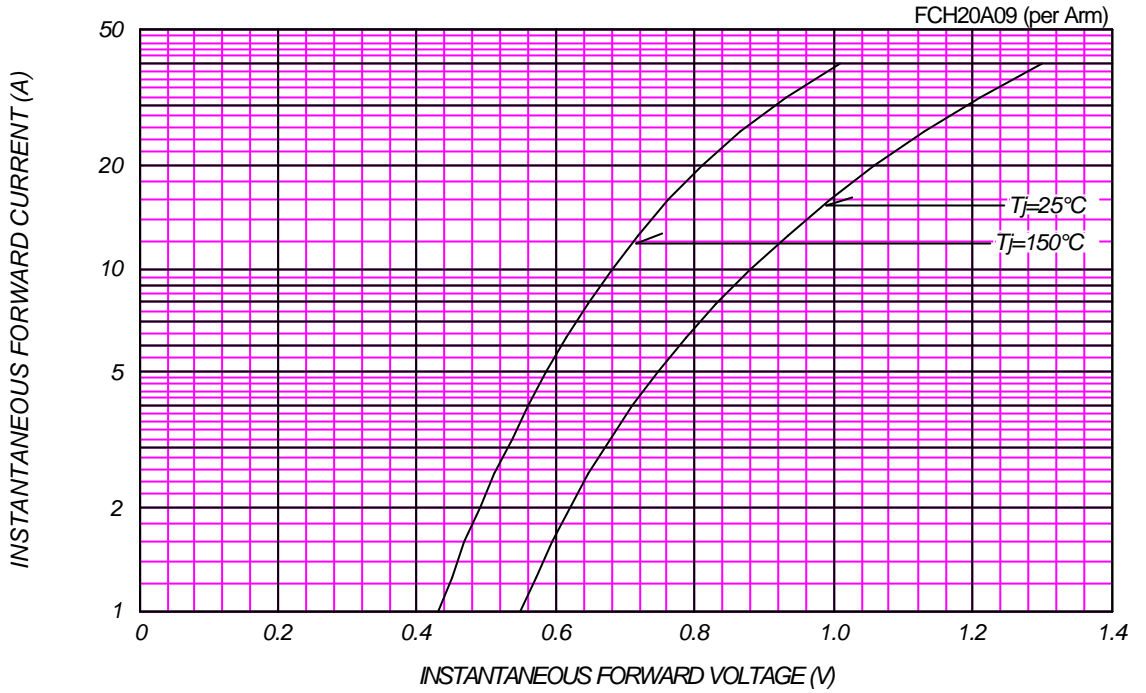

AVERAGE FORWARD POWER DISSIPATION

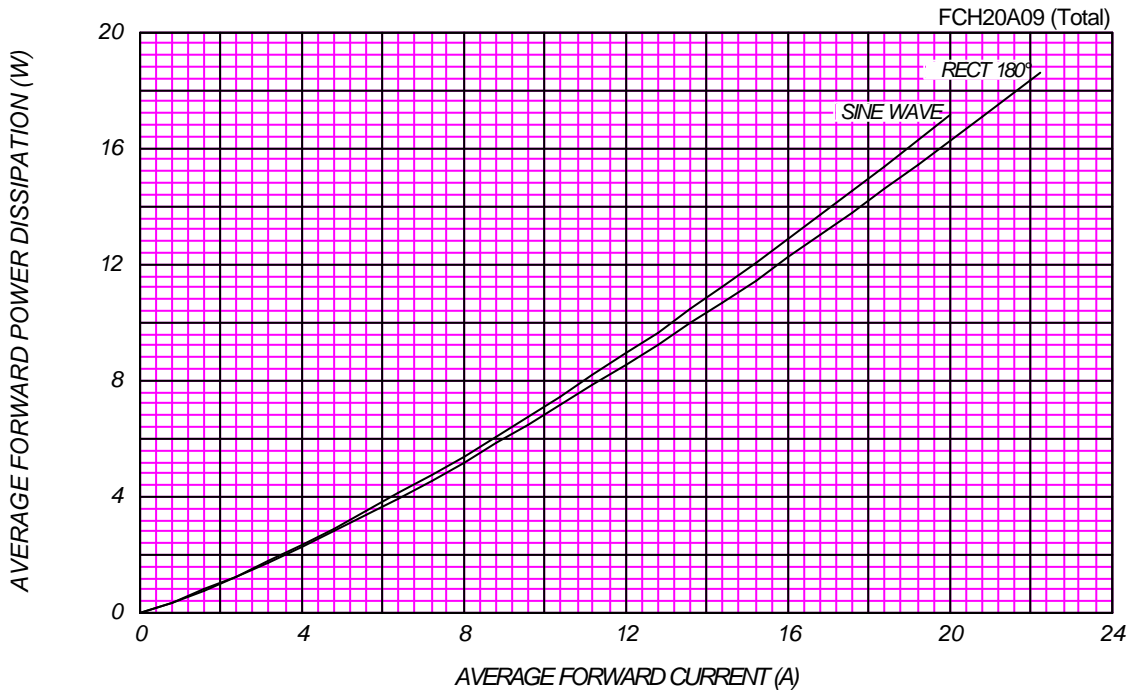

PEAK REVERSE CURRENT VS. PEAK REVERSE VOLTAGE

T_j = 150 °C

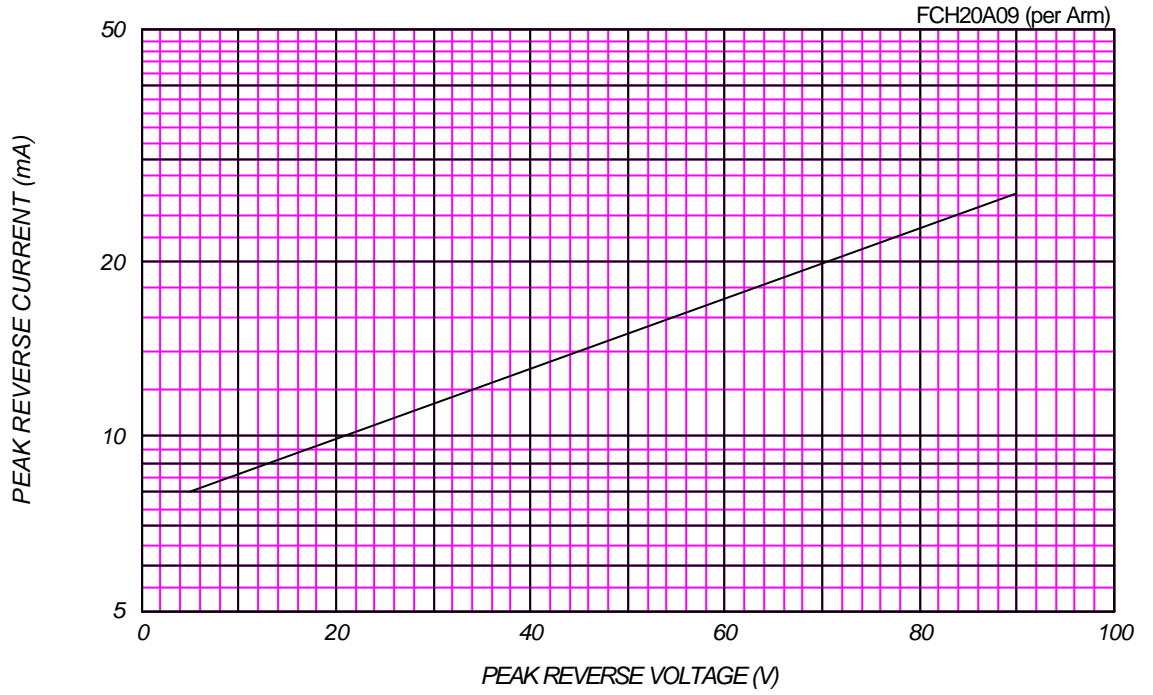

AVERAGE REVERSE POWER DISSIPATION

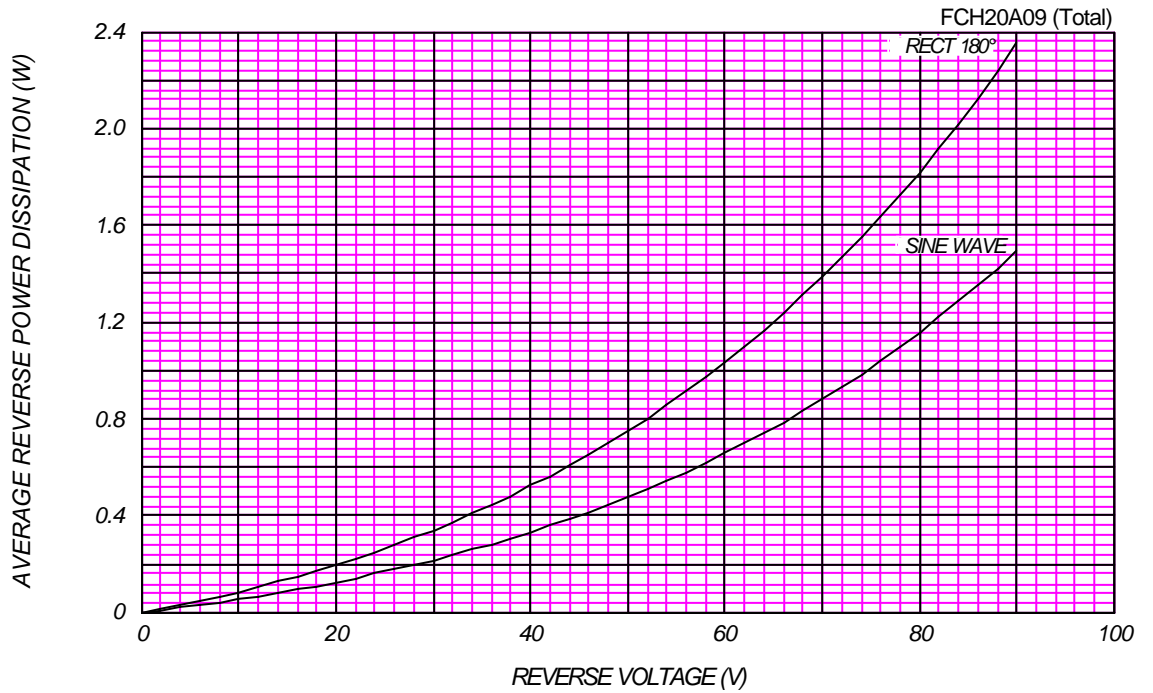



AVERAGE FORWARD CURRENT VS. CASE TEMPERATURE

$V_{RM}=90\text{ V}$

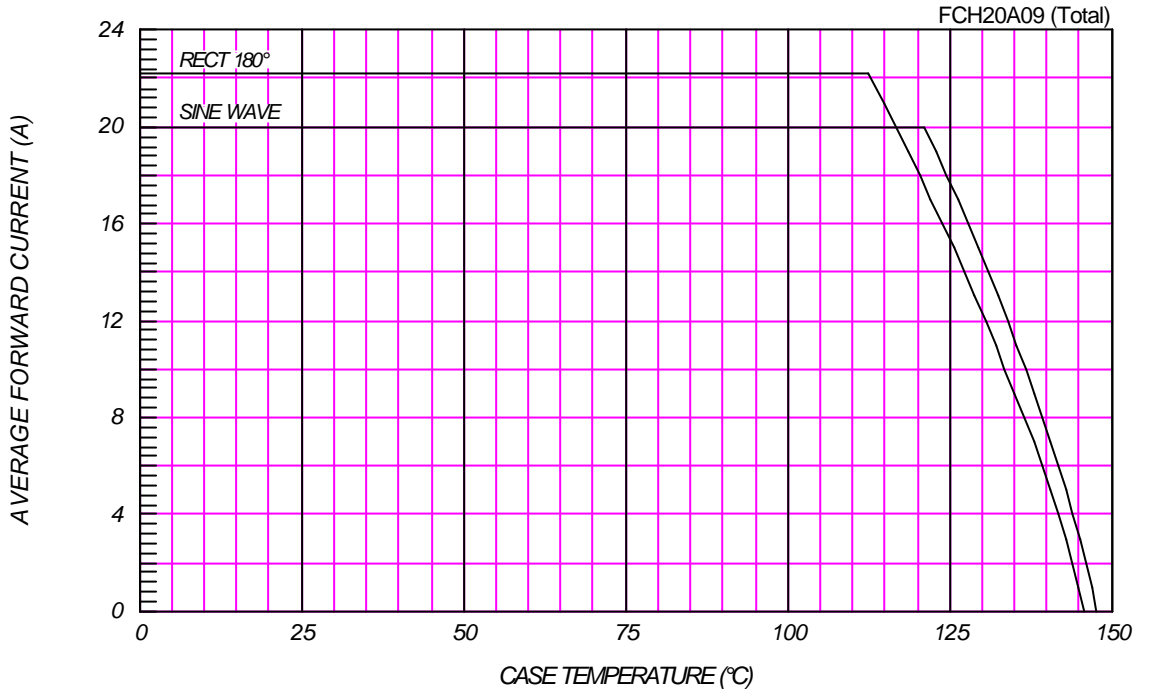

SURGE CURRENT RATINGS

$f=50\text{ Hz}$, Sine Wave, Non-Repetitive, No Load

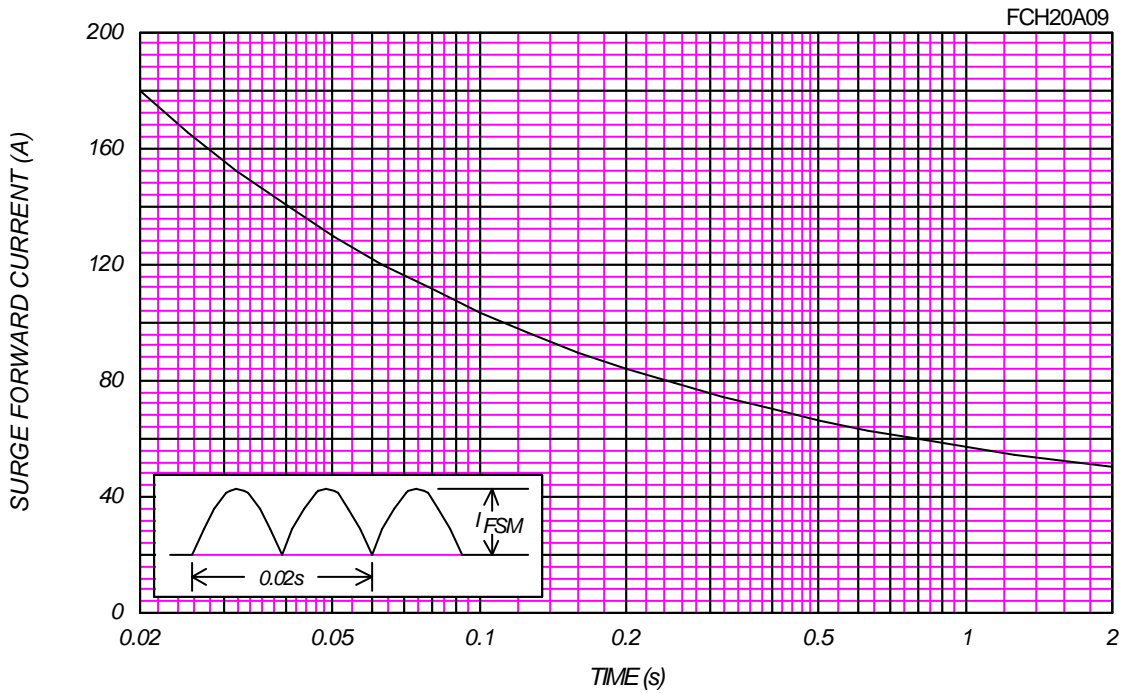

JUNCTION CAPACITANCE VS. REVERSE VOLTAGE

$T_j=25^\circ\text{C}$, $V_m=20\text{mV}_{\text{RMS}}$, $f=100\text{kHz}$, Typical Value

FCH20A09 (per Arm)

