

SBD Type : FCQ20B06

OUTLINE DRAWING

FEATURES

- *Similar to TO-220AB Case
- *Fully Molded Isolation
- *Dual Diodes – Cathode Common
- *Low Forward Voltage Drop
- *High Surge Capability
- *Tj=150 °C operation

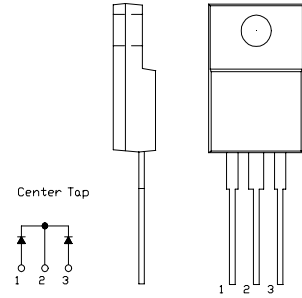

Maximum Ratings

Approx Net Weight: 1.75g

Rating	Symbol	FCQ20B06			Unit
Repetitive Peak Reverse Voltage	V_{RRM}	60			V
Average Rectified Output Current	I_O	20	$T_c=88^\circ\text{C}$	50 Hz Full Sine Wave Resistive Load	A
RMS Forward Current	$I_{F(RMS)}$	22.2			A
Surge Forward Current	I_{FSM}	180	50Hz Full Sine Wave ,1cycle Non-repetitive		A
Operating JunctionTemperature Range	T_{jw}	-40 to +150			°C
Storage Temperature Range	T_{stg}	-40 to +150			°C
Mounting torque	F_{tor}	recommended torque = 0.5			N•m

Electrical • Thermal Characteristics

Characteristics	Symbol	Conditions	Min.	Typ.	Max.	Unit
Peak Reverse Current	I_{RM}	$T_j= 25^\circ\text{C}$, $V_{RM}= V_{RRM}$ per Arm	-	-	10	mA
Peak Forward Voltage	V_{FM}	$T_j= 25^\circ\text{C}$, $I_{FM}= 10\text{ A}$ per Arm	-	-	0.69	V
Thermal Resistance	$R_{th(j-c)}$	Junction to Case	-	-	2.3	°C /W
	$R_{th(c-f)}$	Case to Fin	-	-	1.5	°C /W

FCQ20B06 OUTLINE DRAWING (Dimensions in mm)

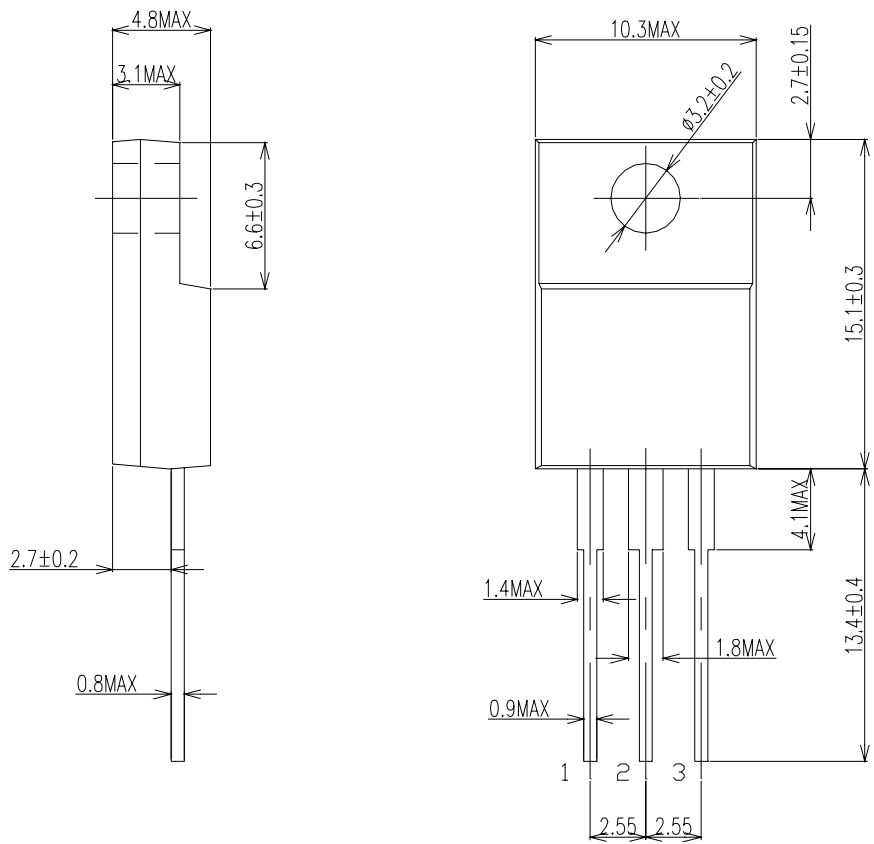

Center Tap

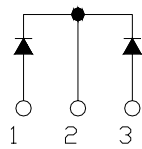

FORWARD CURRENT VS. VOLTAGE

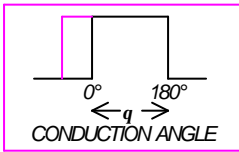
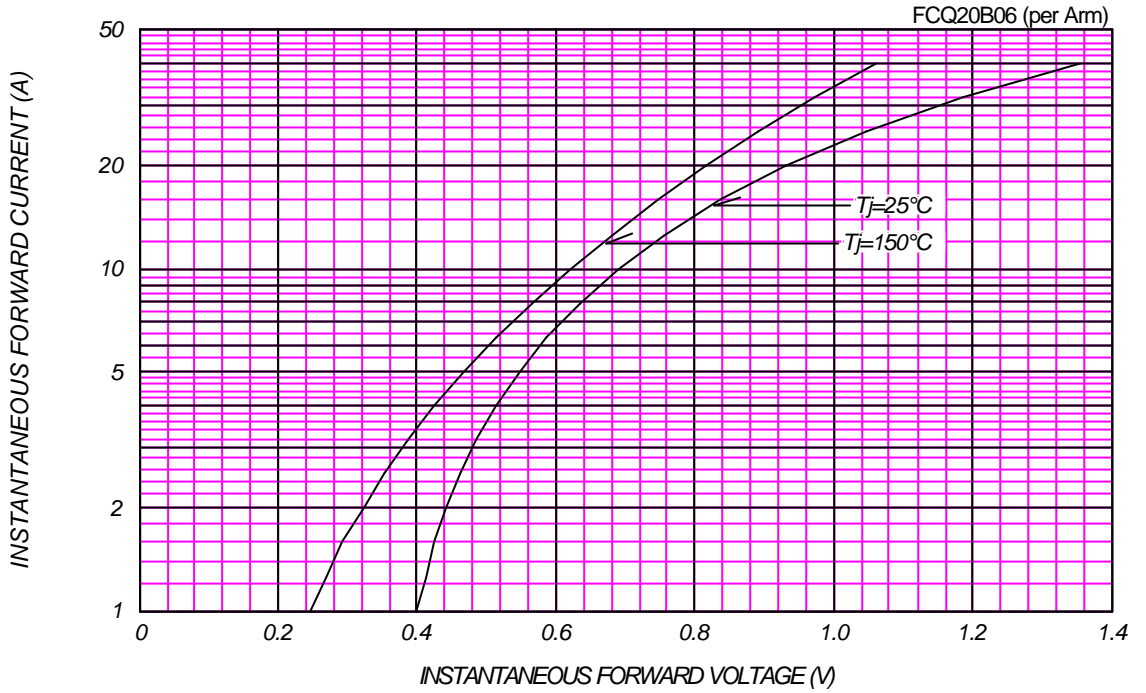

AVERAGE FORWARD POWER DISSIPATION

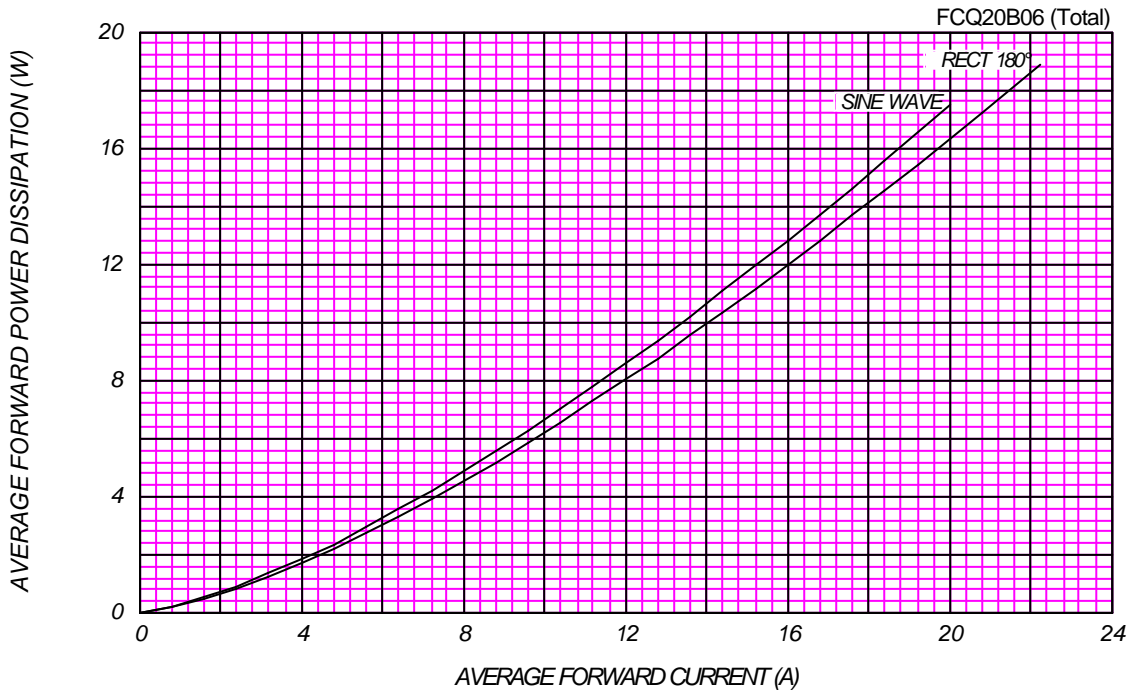

PEAK REVERSE CURRENT VS. PEAK REVERSE VOLTAGE

T_j = 150 °C

FCQ20B06 (per Arm)

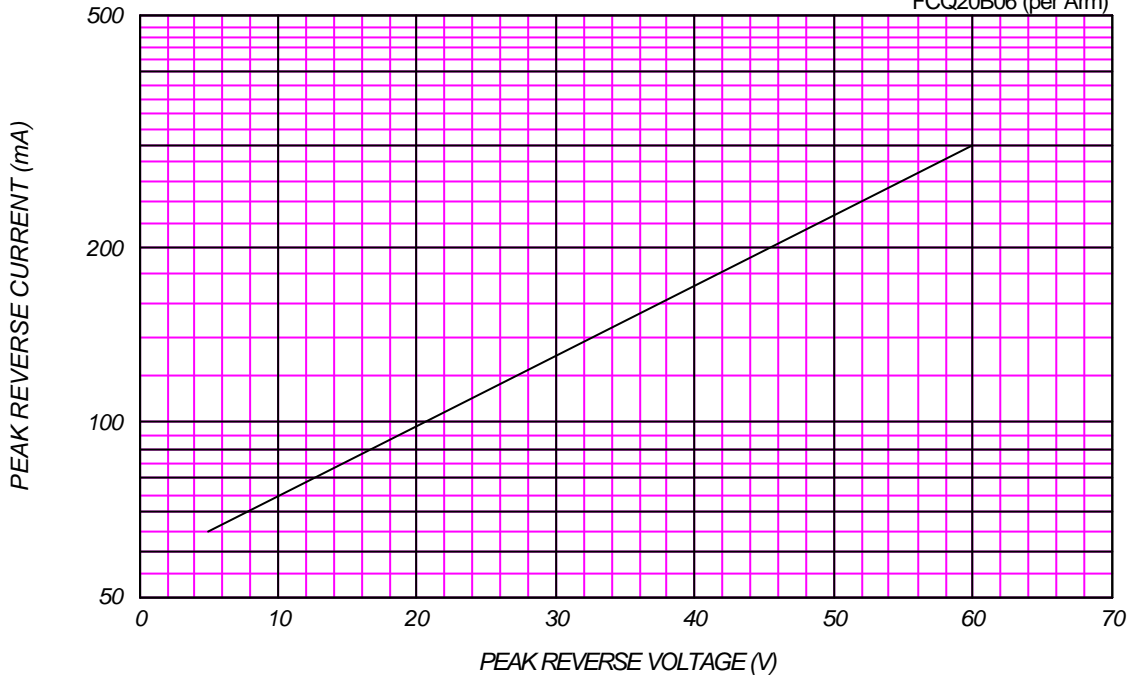

AVERAGE REVERSE POWER DISSIPATION

FCQ20B06 (Total)

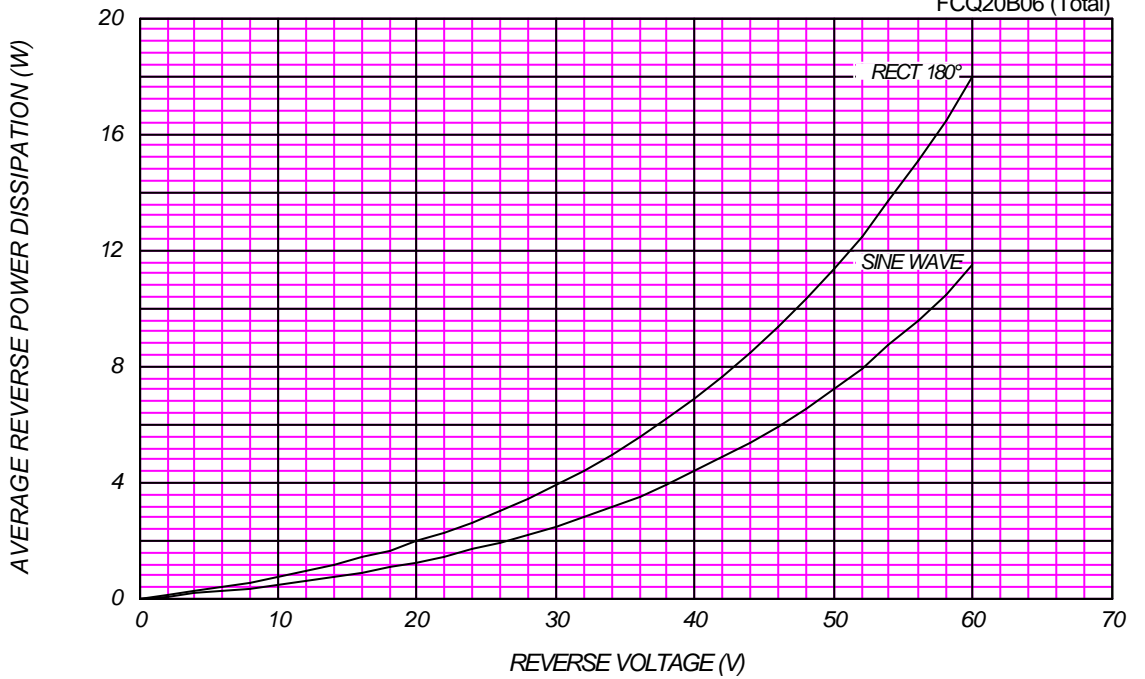

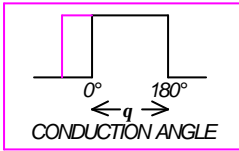

AVERAGE FORWARD CURRENT VS. CASE TEMPERATURE

$V_{RM}=60\text{ V}$

FCQ20B06 (Total)

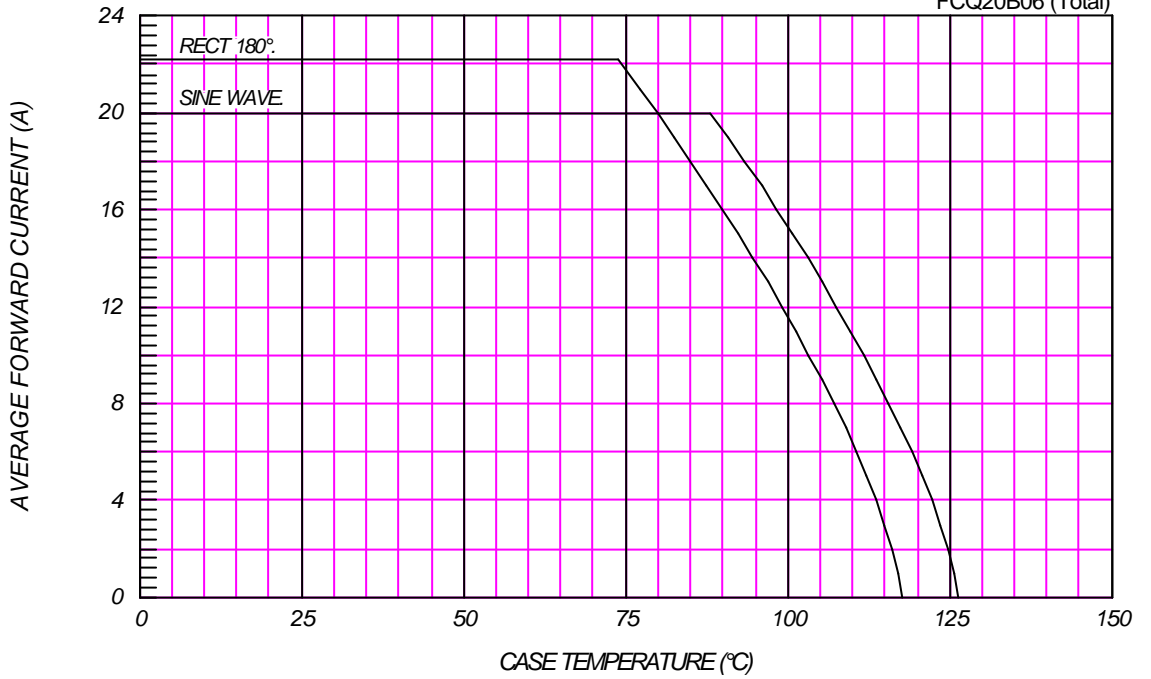

SURGE CURRENT RATINGS

f=50Hz, Sine Wave, Non-Repetitive, No Load

FCQ20B06

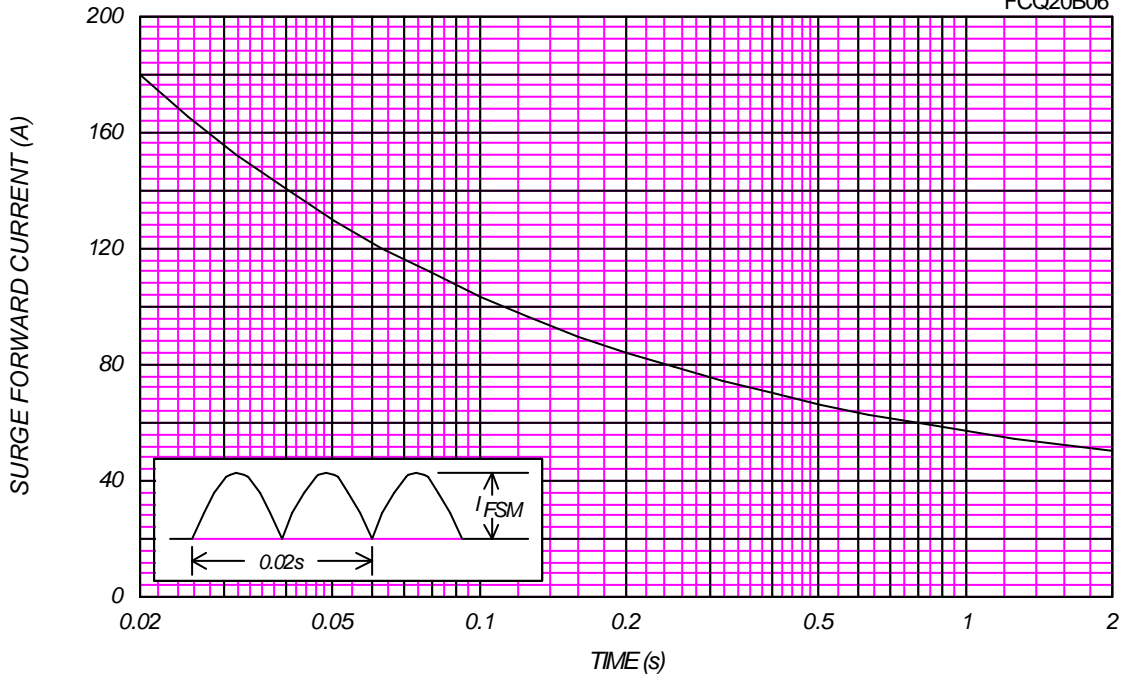

JUNCTION CAPACITANCE VS. REVERSE VOLTAGE

$T_j=25^\circ\text{C}$, $V_m=20\text{mV}_{\text{RMS}}$, $f=100\text{kHz}$, Typical Value

