

# SBD Type : FCQ20C03

OUTLINE DRAWING

**FEATURES**

- \*Similar to TO-220AB Case
- \*Fully Molded Isolation
- \*Dual Diodes – Cathode Common
- \*Low Forward Voltage Drop
- \*Low Power Loss,High Efficiency
- \*High Surge Capability
- \*Tj=150 °C operation

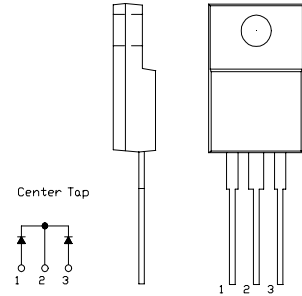

## Maximum Ratings

Approx Net Weight: 1.75g

Rating	Symbol	FCQ20C03		Unit
Repetitive Peak Reverse Voltage	$V_{RRM}$	30		V
Repetitive Peak Surge Reverse Voltage	$V_{RRSM}$	35(pulse width $\leq 1\mu s$ duty $\leq 1/50$ )		V
Average Rectified Output Current	$I_O$	20	$T_c=104^\circ C$ 50 Hz Full Sine Wave Resistive Load	A
RMS Forward Current	$I_{F(RMS)}$	22.2		A
Surge Forward Current	$I_{FSM}$	180	50Hz Full Sine Wave ,1cycle Non-repetitive	A
Operating JunctionTemperature Range	$T_{jw}$	-40 to +150		$^\circ C$
Storage Temperature Range	$T_{stg}$	-40 to +150		$^\circ C$
Mounting torque	Ftor	recommended torque = 0.5		N•m

## Electrical • Thermal Characteristics

Characteristics	Symbol	Conditions	Min.	Typ.	Max.	Unit
Peak Reverse Current	$I_{RM}$	$T_j= 25^\circ C, V_{RM}= V_{RRM}$ per Arm	-	-	10	mA
Peak Forward Voltage	$V_{FM}$	$T_j= 25^\circ C, I_{FM}= 10 A$ per Arm	-	-	0.51	V
Thermal Resistance	$R_{th(j-c)}$	Junction to Case	-	-	2.3	$^\circ C/W$
	$R_{th(c-f)}$	Cace to Fin	-	-	1.5	$^\circ C/W$

FCQ\_C\_ OUTLINE DRAWING (Dimensions in mm)

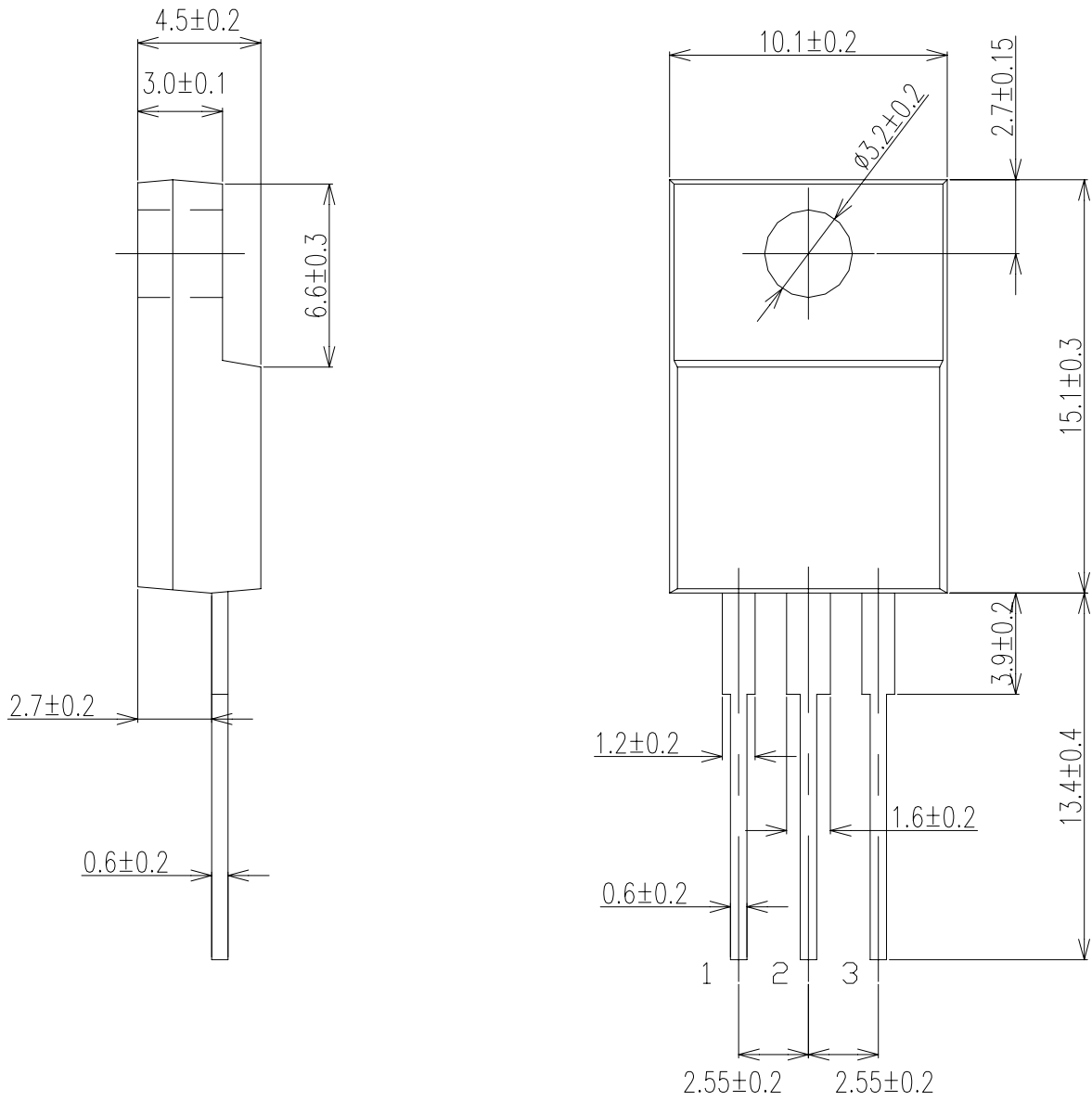

Center Tap

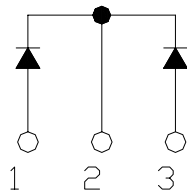

### FORWARD CURRENT VS. VOLTAGE

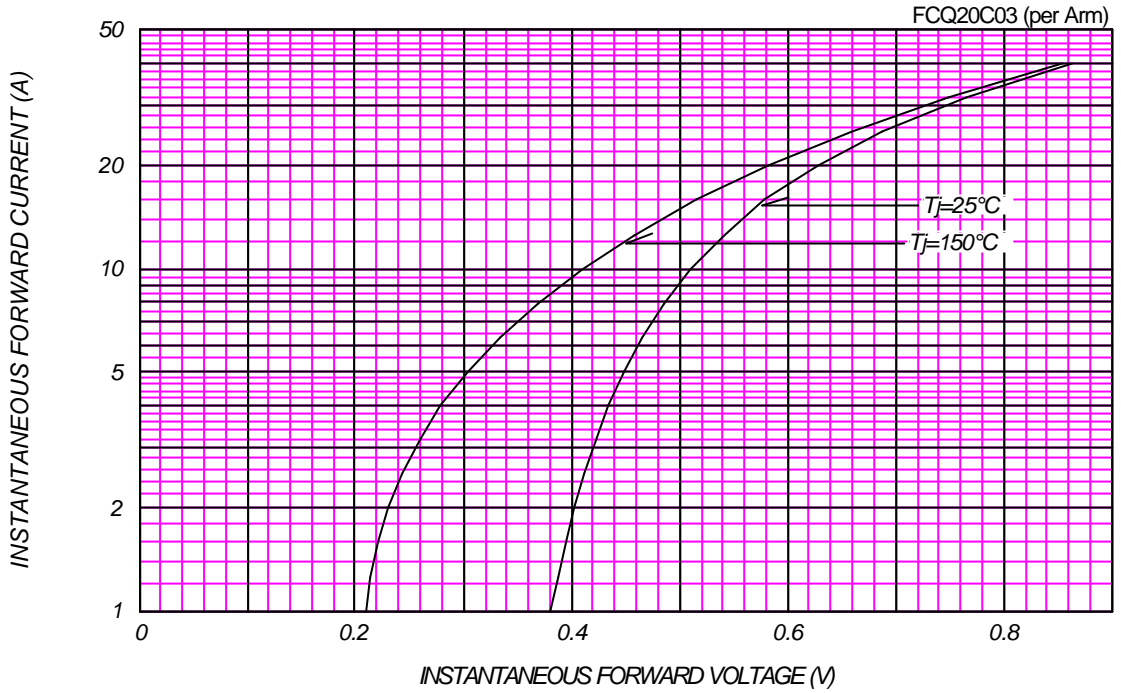

### AVERAGE FORWARD POWER DISSIPATION

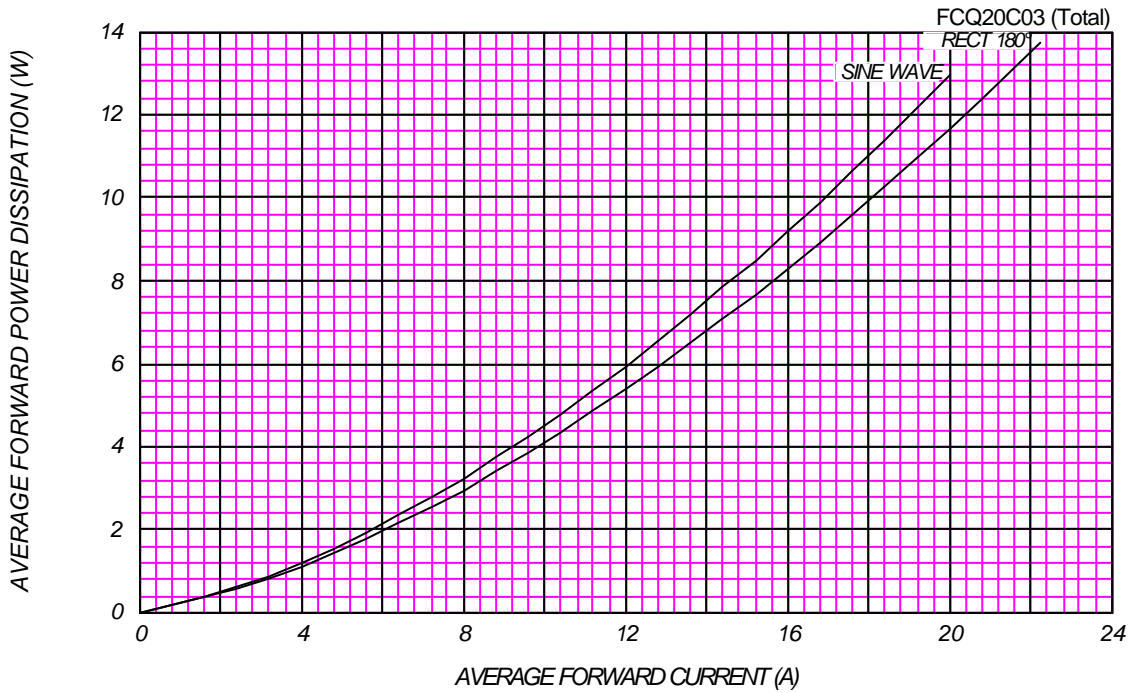

PEAK REVERSE CURRENT VS. PEAK REVERSE VOLTAGE

T<sub>j</sub> = 150 °C

FCQ20C03 (per Arm)

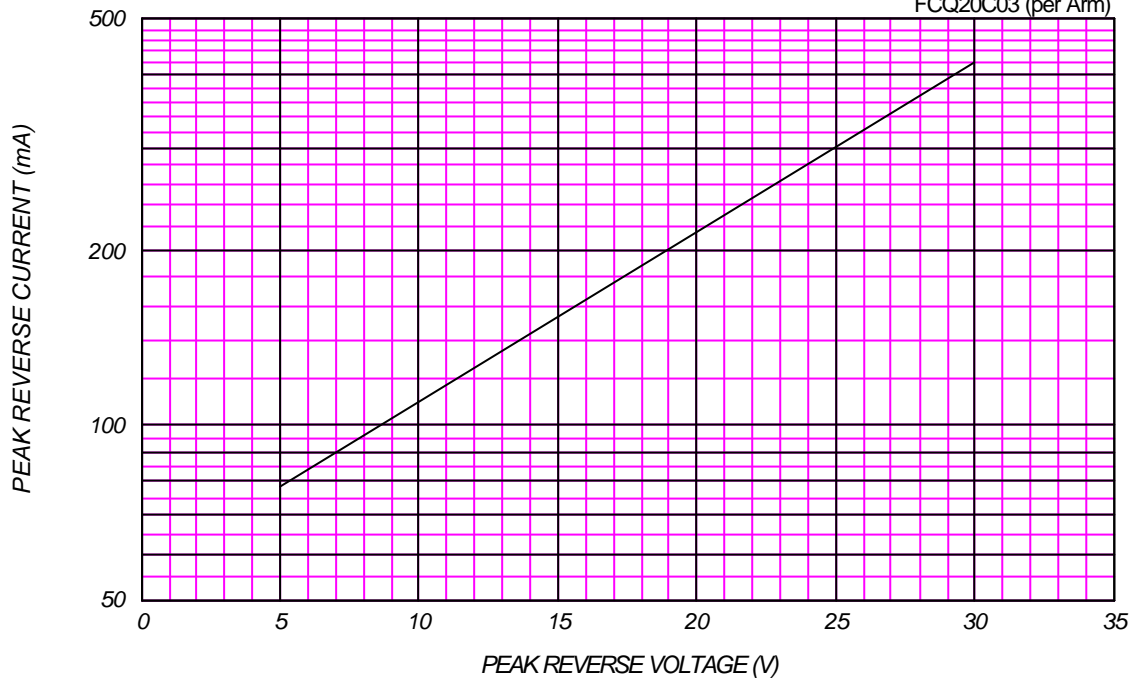

AVERAGE REVERSE POWER DISSIPATION

FCQ20C03 (Total)

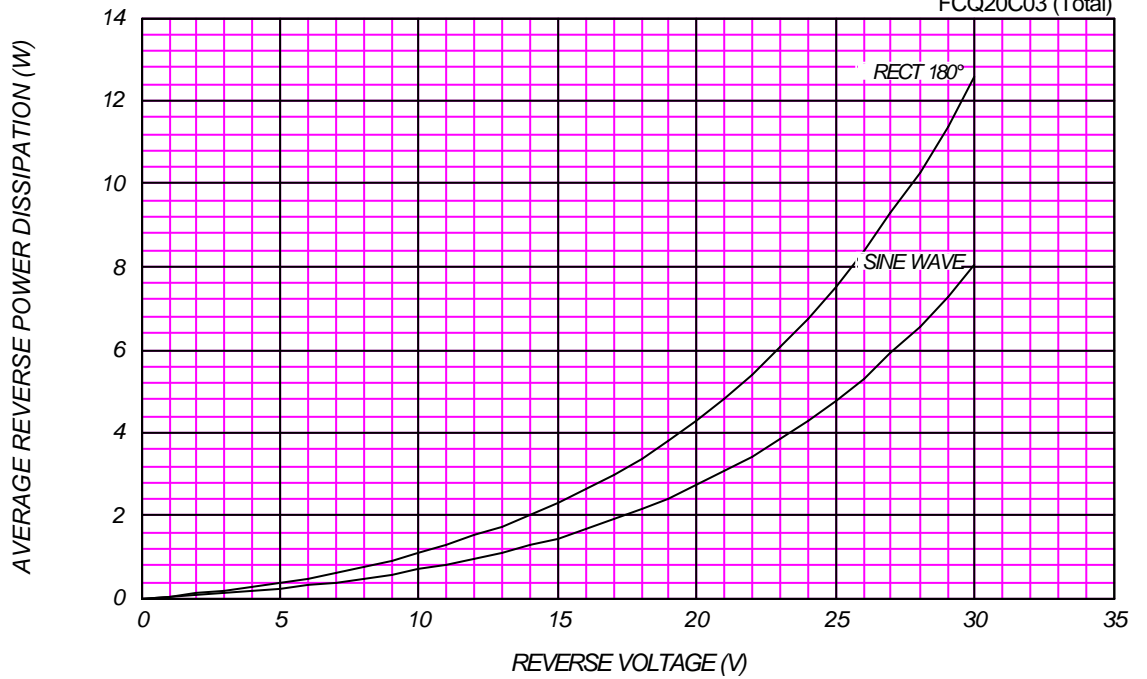

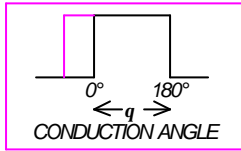

### AVERAGE FORWARD CURRENT VS. CASE TEMPERATURE

$V_{RM}=30\text{ V}$

FCQ20C03 (Total)

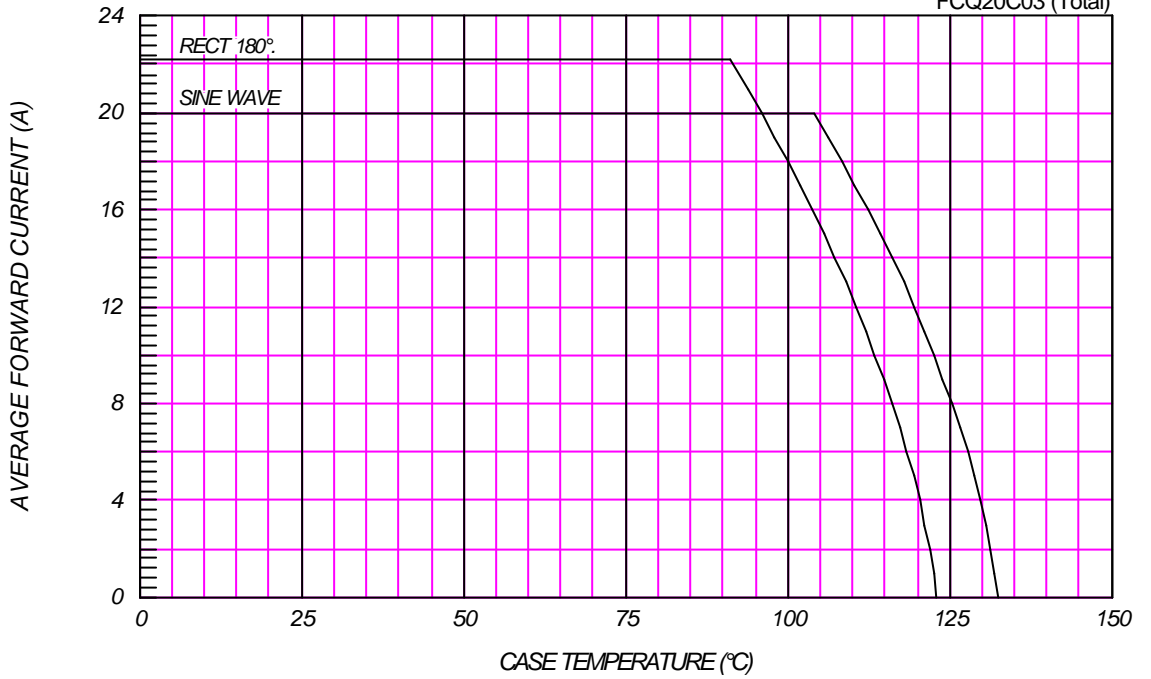

### SURGE CURRENT RATINGS

f=50Hz, Sine Wave, Non-Repetitive, No Load

FCQ20C03

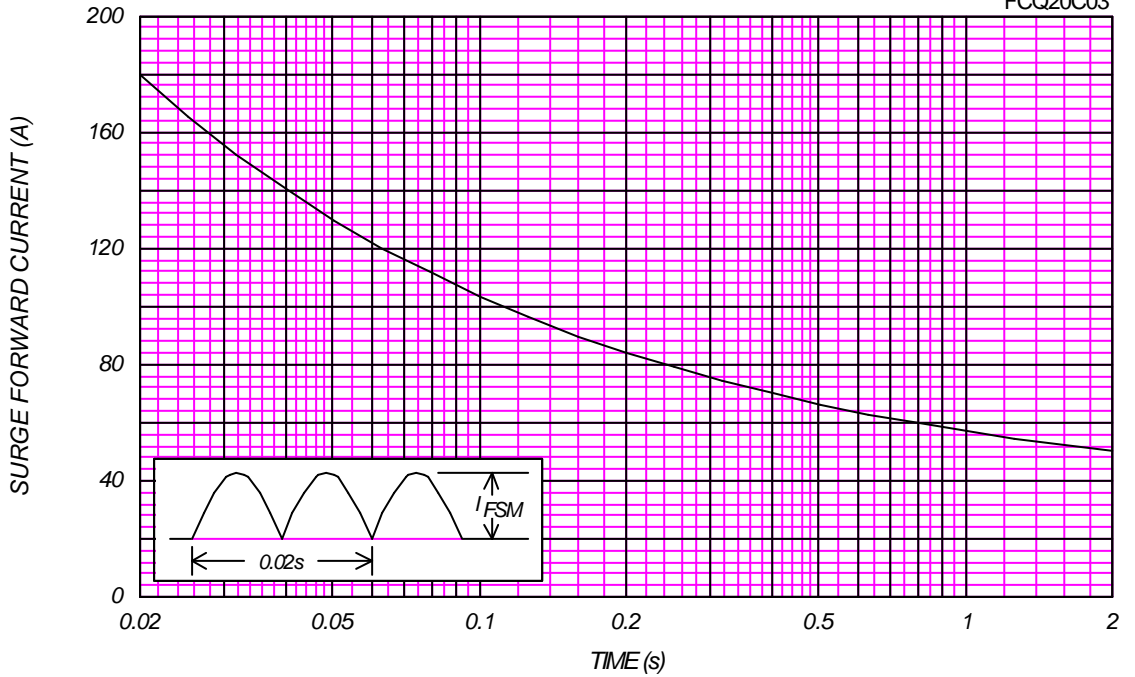

JUNCTION CAPACITANCE VS. REVERSE VOLTAGE

$T_j=25^\circ\text{C}$ ,  $V_m=20\text{mV}_{\text{RMS}}$ ,  $f=100\text{kHz}$ , Typical Value

FCQ20C03 (per Arm)

