



July 2000
PRELIMINARY

FDN5618P

60V P-Channel Logic Level PowerTrench® MOSFET

General Description

This 60V P-Channel MOSFET uses Fairchild's high voltage PowerTrench process. It has been optimized for power management applications.

Applications

- DC-DC converters
- Load switch
- Power management

Features

- -1.25 A, -60 V. $R_{DS(ON)} = 0.170 \Omega @ V_{GS} = -10 \text{ V}$
 $R_{DS(ON)} = 0.230 \Omega @ V_{GS} = -4.5 \text{ V}$
- Fast switching speed
- High performance trench technology for extremely low $R_{DS(ON)}$

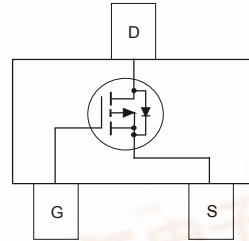
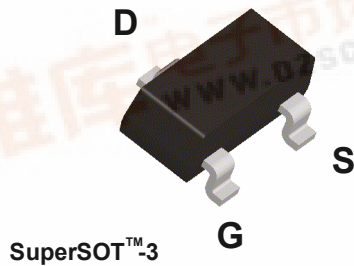

Absolute Maximum Ratings T_A=25°C unless otherwise noted

| Symbol | Parameter | Ratings | Units |
|-----------------------------------|--|-------------|-------|
| V _{DSS} | Drain-Source Voltage | -60 | V |
| V _{GSS} | Gate-Source Voltage | ±20 | V |
| I _D | Drain Current – Continuous (Note 1a) – Pulsed | -1.25 | A |
| | | -10 | |
| P _D | Maximum Power Dissipation (Note 1a) (Note 1b) | 0.5 | W |
| | | 0.46 | |
| T _J , T _{STG} | Operating and Storage Junction Temperature Range | -55 to +150 | °C |

Thermal Characteristics

| | | | |
|------------------|---|-----|------|
| R _{θJA} | Thermal Resistance, Junction-to-Ambient (Note 1a) | 250 | °C/W |
| R _{θJC} | Thermal Resistance, Junction-to-Case (Note 1) | 75 | °C/W |

Package Marking and Ordering Information

| Device Marking | Device | Reel Size | Tape width | Quantity |
|----------------|----------|-----------|------------|------------|
| 618 | FDN5618P | 7" | 8mm | 3000 units |



Electrical Characteristics $T_A = 25^\circ\text{C}$ unless otherwise noted

| Symbol | Parameter | Test Conditions | Min | Typ | Max | Units |
|---|---|---|-----|-------------------------|-------------------------|----------------------|
| Off Characteristics | | | | | | |
| BV_{DSS} | Drain–Source Breakdown Voltage | $V_{GS} = 0\text{ V}, I_D = -250\ \mu\text{A}$ | -60 | | | V |
| $\frac{\Delta BV_{DSS}}{\Delta T_J}$ | Breakdown Voltage Temperature Coefficient | $I_D = -250\ \mu\text{A}$, Referenced to 25°C | | -58 | | mV/ $^\circ\text{C}$ |
| I_{DSS} | Zero Gate Voltage Drain Current | $V_{DS} = -48\text{ V}, V_{GS} = 0\text{ V}$ | | | -1 | μA |
| I_{GSSF} | Gate–Body Leakage, Forward | $V_{GS} = 20\text{ V}, V_{DS} = 0\text{ V}$ | | | 100 | nA |
| I_{GSSR} | Gate–Body Leakage, Reverse | $V_{GS} = -20\text{ V}, V_{DS} = 0\text{ V}$ | | | -100 | nA |
| On Characteristics (Note 2) | | | | | | |
| $V_{GS(th)}$ | Gate Threshold Voltage | $V_{DS} = V_{GS}, I_D = -250\ \mu\text{A}$ | -1 | -1.6 | -3 | V |
| $\frac{\Delta V_{GS(th)}}{\Delta T_J}$ | Gate Threshold Voltage Temperature Coefficient | $I_D = -250\ \mu\text{A}$, Referenced to 25°C | | 4 | | mV/ $^\circ\text{C}$ |
| $R_{DS(on)}$ | Static Drain–Source On–Resistance | $V_{GS} = -10\text{ V}, I_D = -1.25\text{ A}$ $V_{GS} = -4.5\text{ V}, I_D = -1.0\text{ A}$ $V_{GS} = -10\text{ V}, I_D = -3\text{ A}, T_J = 125^\circ\text{C}$ | | 0.148 0.185 0.245 | 0.170 0.230 0.315 | Ω |
| $I_{D(on)}$ | On–State Drain Current | $V_{GS} = -10\text{ V}, V_{DS} = -5\text{ V}$ | -5 | | | A |
| g_{FS} | Forward Transconductance | $V_{DS} = -5\text{ V}, I_D = -1.25\text{ A}$ | | 4.3 | | S |
| Dynamic Characteristics | | | | | | |
| C_{iss} | Input Capacitance | $V_{DS} = -30\text{ V}, V_{GS} = 0\text{ V},$ | | 430 | | pF |
| C_{oss} | Output Capacitance | $f = 1.0\text{ MHz}$ | | 52 | | pF |
| C_{rss} | Reverse Transfer Capacitance | | | 19 | | pF |
| Switching Characteristics (Note 2) | | | | | | |
| $t_{d(on)}$ | Turn–On Delay Time | $V_{DD} = -30\text{ V}, I_D = -1\text{ A},$ | | 6.5 | 13 | ns |
| t_r | Turn–On Rise Time | $V_{GS} = -10\text{ V}, R_{GEN} = 6\ \Omega$ | | 8 | 16 | ns |
| $t_{d(off)}$ | Turn–Off Delay Time | | | 16.5 | 30 | ns |
| t_f | Turn–Off Fall Time | | | 4 | 8 | ns |
| Q_g | Total Gate Charge | $V_{DS} = -30\text{ V}, I_D = -1.25\text{ A},$ | | 8.6 | 13.8 | nC |
| Q_{gs} | Gate–Source Charge | $V_{GS} = -10\text{ V}$ | | 1.5 | | nC |
| Q_{gd} | Gate–Drain Charge | | | 1.3 | | nC |
| Drain–Source Diode Characteristics and Maximum Ratings | | | | | | |
| I_S | Maximum Continuous Drain–Source Diode Forward Current | | | | -0.42 | A |
| V_{SD} | Drain–Source Diode Forward Voltage | $V_{GS} = 0\text{ V}, I_S = -0.42$ (Note 2) | | -0.7 | -1.2 | V |

Notes:

- $R_{\theta JA}$ is the sum of the junction-to-case and case-to-ambient thermal resistance where the case thermal reference is defined as the solder mounting surface of the drain pins. $R_{\theta JC}$ is guaranteed by design while $R_{\theta CA}$ is determined by the user's board design.



a) 250°C/W when mounted on a 0.02 in^2 pad of 2 oz. copper.



b) 270°C/W when mounted on a minimum pad.

Scale 1 : 1 on letter size paper

- Pulse Test: Pulse Width $\leq 300\ \mu\text{s}$, Duty Cycle ≤ 2.0

Typical Characteristics

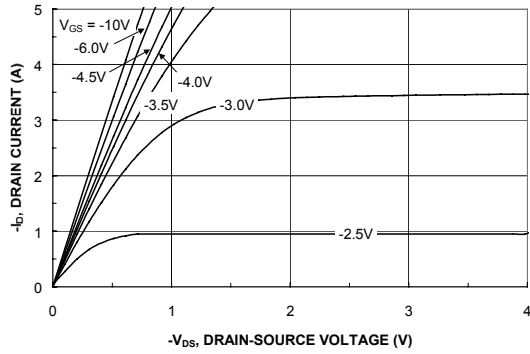

Figure 1. On-Region Characteristics.

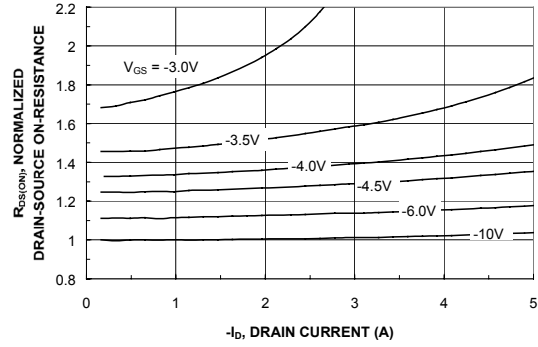

Figure 2. On-Resistance Variation with Drain Current and Gate Voltage.

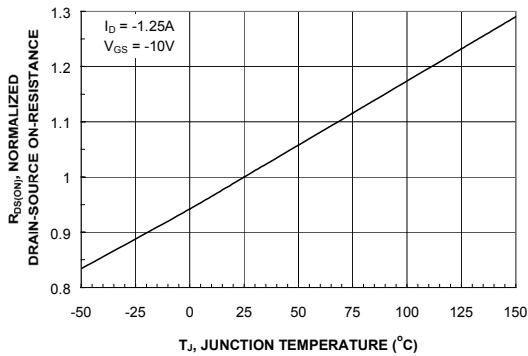

Figure 3. On-Resistance Variation with Temperature.

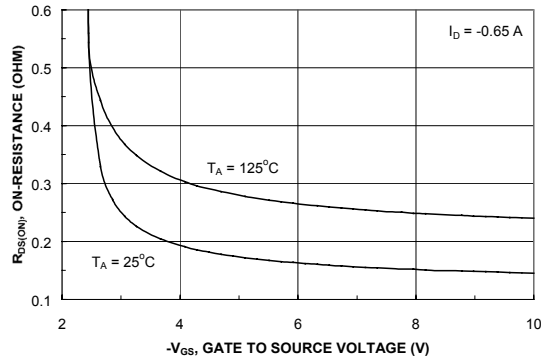

Figure 4. On-Resistance Variation with Gate-to-Source Voltage.

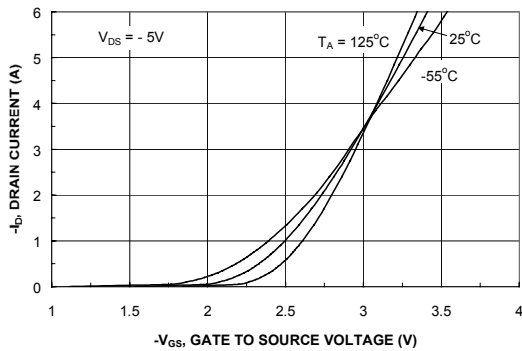

Figure 5. Transfer Characteristics.

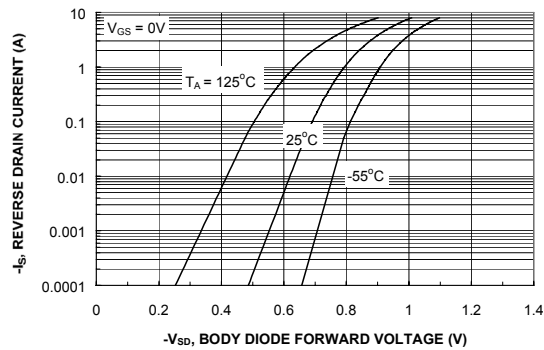

Figure 6. Body Diode Forward Voltage Variation with Source Current and Temperature.

Typical Characteristics

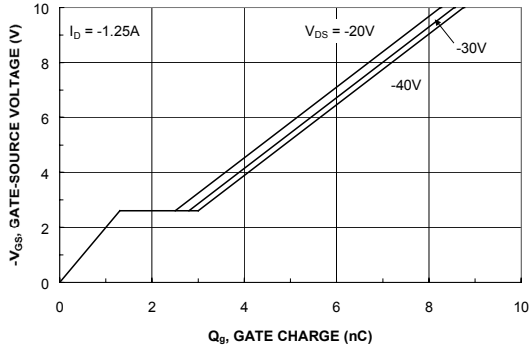

Figure 7. Gate Charge Characteristics.

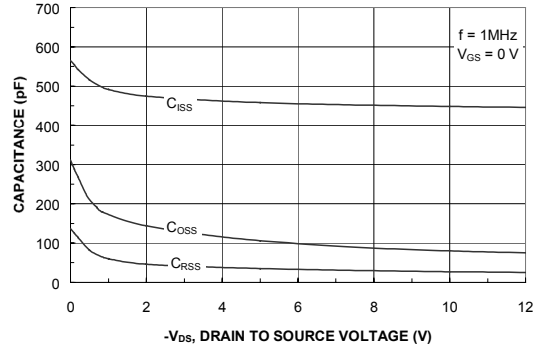

Figure 8. Capacitance Characteristics.

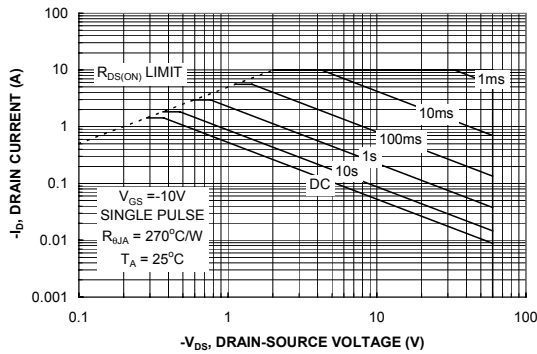

Figure 9. Maximum Safe Operating Area.

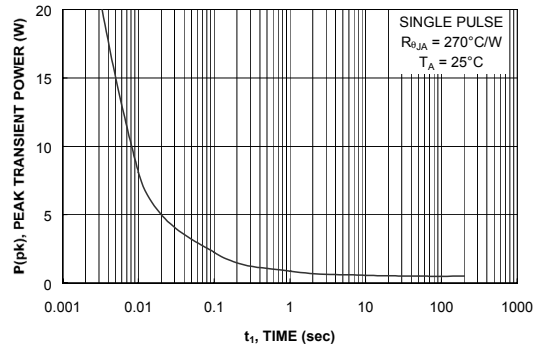

Figure 10. Single Pulse Maximum Power Dissipation.

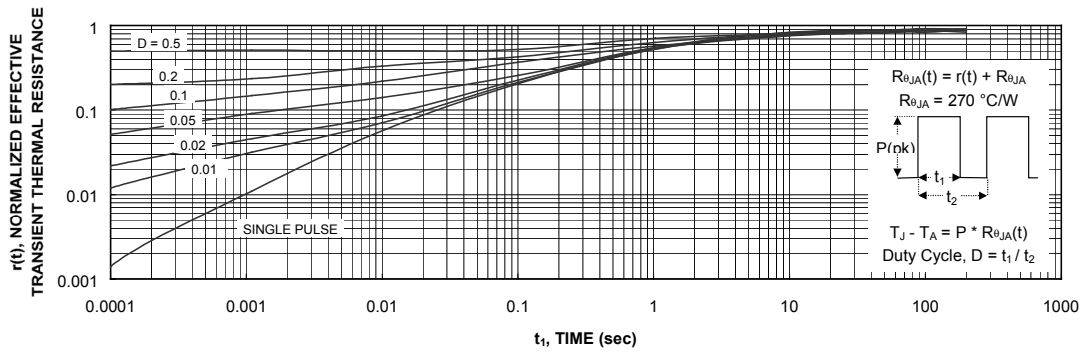

Figure 11. Transient Thermal Response Curve.

Thermal characterization performed using the conditions described in Note 1b. Transient thermal response will change depending on the circuit board design.

SuperSOT™-3 Tape and Reel Data and Package Dimensions



SSOT-3 Packaging Configuration: Figure 1.0

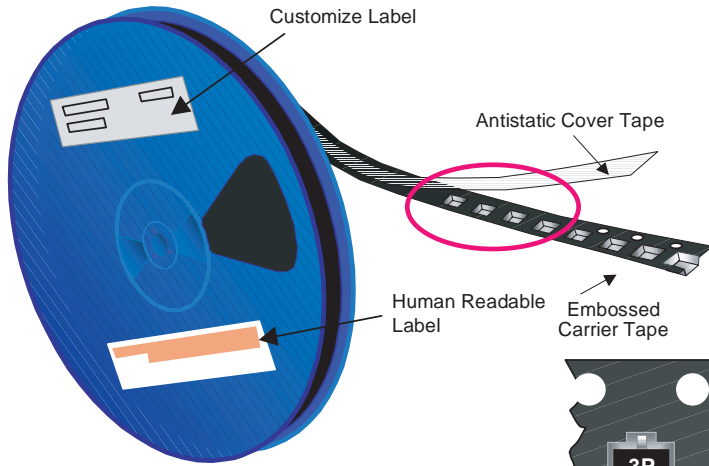

Packaging Description:

SSOT-3 parts are shipped in tape. The carrier tape is made from a dissipative (carbon filled) polycarbonate resin. The cover tape is a multilayer film (Heat Activated Adhesive in nature) primarily composed of polyester film, adhesive layer, sealant, and anti-static sprayed agent. These reeled parts in standard option are shipped with 3,000 units per 7" or 177cm diameter reel. The reels are dark blue in color and is made of polystyrene plastic (anti-static coated). Other option comes in 10,000 units per 13" or 330cm diameter reel. This and some other options are described in the Packaging Information table.

These full reels are individually labeled and placed inside a standard intermediate made of recyclable corrugated brown paper with a Fairchild logo printing. One pizza box contains eight reels maximum. And these intermediate boxes are placed inside a labeled shipping box which comes in different sizes depending on the number of parts shipped.

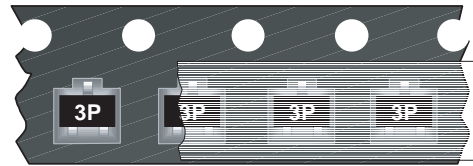

| SSOT-3 Std Packaging Information | | |
|----------------------------------|-------------------------|------------|
| Packaging Option | Standard (no flow code) | D87Z |
| Packaging type | TNR | TNR |
| Qty per Reel/Tube/Bag | 3,000 | 10,000 |
| Reel Size | 7" Dia | 13" |
| Box Dimension (mm) | 187x107x183 | 343x343x64 |
| Max qty per Box | 24,000 | 30,000 |
| Weight per unit (gm) | 0.0097 | 0.0097 |
| Weight per Reel (kg) | 0.1230 | 0.4150 |
| Note/Comments | | |

SSOT-3 Std Unit Orientation

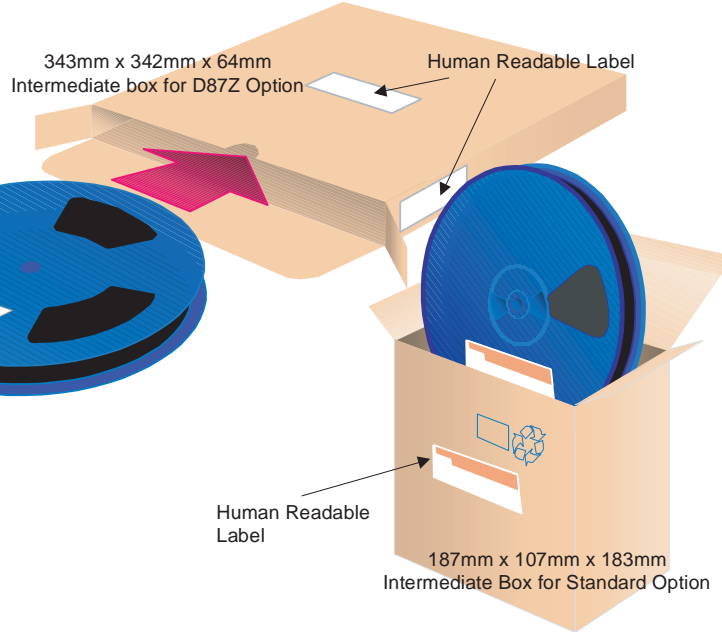

Human Readable Label sample



SSOT-3 Tape Leader and Trailer Configuration: Figure 2.0

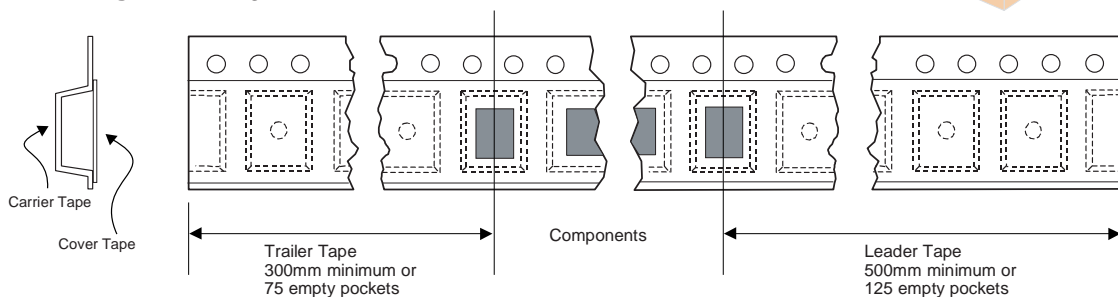

SuperSOT™-3 Tape and Reel Data and Package Dimensions, continued

SSOT-3 Embossed Carrier Tape Configuration: Figure 3.0

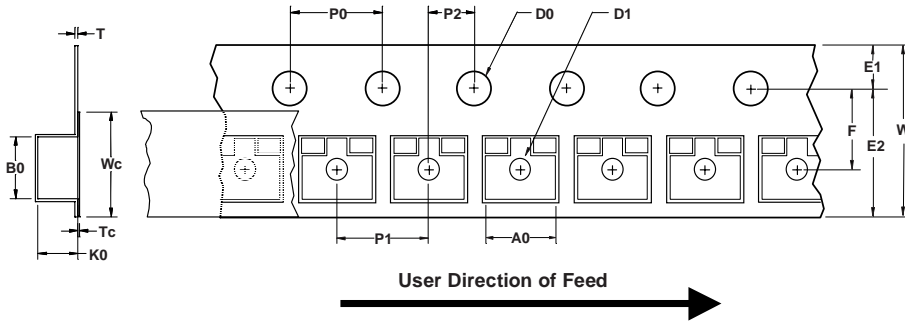

Dimensions are in millimeter

| Pkg type | A0 | B0 | W | D0 | D1 | E1 | E2 | F | P1 | P0 | K0 | T | Wc | Tc |
|--------------|-----------------|-----------------|---------------|-----------------|-------------------|-----------------|-------------|-----------------|---------------|---------------|-----------------|-------------------|---------------|-----------------|
| SSOT-3 (8mm) | 3.15 +/-0.10 | 2.77 +/-0.10 | 8.0 +/-0.3 | 1.55 +/-0.05 | 1.125 +/-0.125 | 1.75 +/-0.10 | 6.25 min | 3.50 +/-0.05 | 4.0 +/-0.1 | 4.0 +/-0.1 | 1.30 +/-0.10 | 0.228 +/-0.013 | 5.2 +/-0.3 | 0.06 +/-0.02 |

Notes: A0, B0, and K0 dimensions are determined with respect to the EIA/Jedec RS-481 rotational and lateral movement requirements (see sketches A, B, and C).

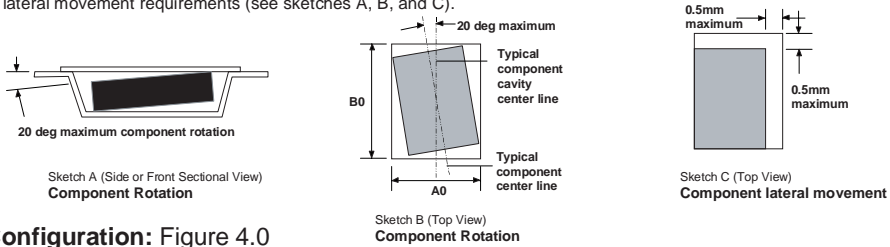

SSOT-3 Reel Configuration: Figure 4.0

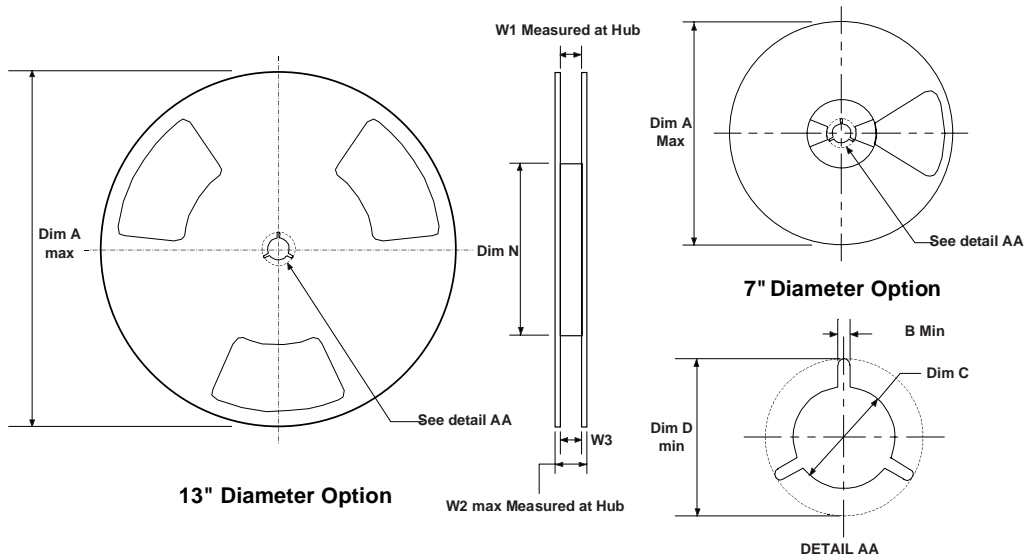

Dimensions are in inches and millimeters

| Tape Size | Reel Option | Dim A | Dim B | Dim C | Dim D | Dim N | Dim W1 | Dim W2 | Dim W3 (LSL-USL) |
|-----------|-------------|---------------|--------------|-----------------------------------|---------------|-------------|-----------------------------------|---------------|-----------------------------|
| 8mm | 7" Dia | 7.00 177.8 | 0.059 1.5 | 512 +0.020/-0.008 13 +0.5/-0.2 | 0.795 20.2 | 2.165 55 | 0.331 +0.059/-0.000 8.4 +1.5/0 | 0.567 14.4 | 0.311 - 0.429 7.9 - 10.9 |
| 8mm | 13" Dia | 13.00 330 | 0.059 1.5 | 512 +0.020/-0.008 13 +0.5/-0.2 | 0.795 20.2 | 4.00 100 | 0.331 +0.059/-0.000 8.4 +1.5/0 | 0.567 14.4 | 0.311 - 0.429 7.9 - 10.9 |

SuperSOT™-3 Tape and Reel Data and Package Dimensions, continued

SuperSOT™-3 (FS PKG Code 32)

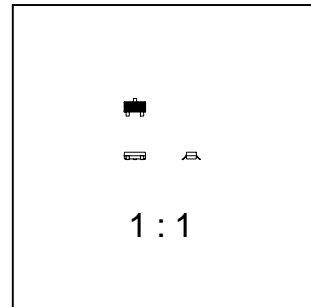
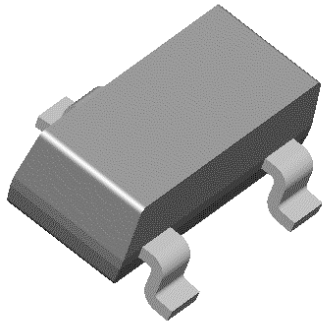

Scale 1:1 on letter size paper

Dimensions shown below are in:
inches [millimeters]

Part Weight per unit (gram): 0.0097

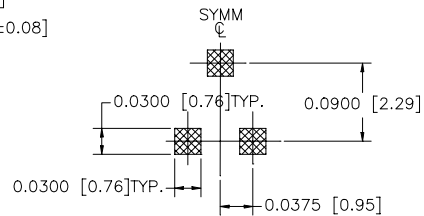
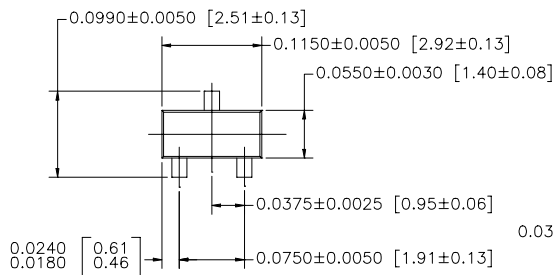

LAND PATTERN RECOMMENDATION

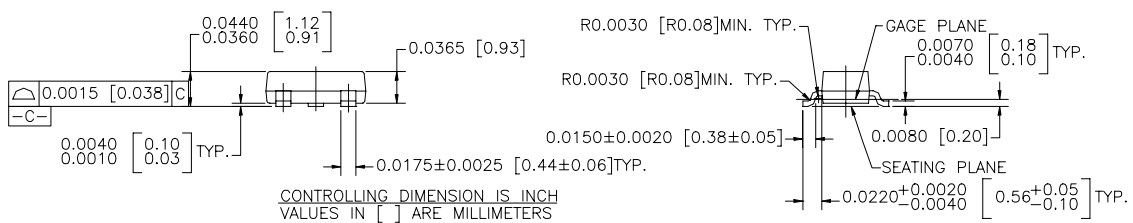

NOTES : UNLESS OTHERWISE SPECIFIED

SUPER SOT , 3 LEADS

- STANDARD LEAD FINISH TO BE 150 MICROINCHES / 3.81 MICROMETERS MINIMUM TIN/LEAD (SOLDER) ON COPPER.
- NO JEDEC REGISTRATION AS OF DEC. 1995.

TRADEMARKS

The following are registered and unregistered trademarks Fairchild Semiconductor owns or is authorized to use and is not intended to be an exhaustive list of all such trademarks.

| | | |
|----------------------|---------------|-------------|
| ACEx™ | HiSeC™ | SuperSOT™-8 |
| Bottomless™ | ISOPLANAR™ | SyncFET™ |
| CoolFET™ | MICROWIRE™ | TinyLogic™ |
| CROSSVOLT™ | POP™ | UHC™ |
| E ² CMOS™ | PowerTrench® | VCX™ |
| FACT™ | QFET™ | |
| FACT Quiet Series™ | QS™ | |
| FAST® | Quiet Series™ | |
| FASTr™ | SuperSOT™-3 | |
| GTO™ | SuperSOT™-6 | |

DISCLAIMER

FAIRCHILD SEMICONDUCTOR RESERVES THE RIGHT TO MAKE CHANGES WITHOUT FURTHER NOTICE TO ANY PRODUCTS HEREIN TO IMPROVE RELIABILITY, FUNCTION OR DESIGN. FAIRCHILD DOES NOT ASSUME ANY LIABILITY ARISING OUT OF THE APPLICATION OR USE OF ANY PRODUCT OR CIRCUIT DESCRIBED HEREIN; NEITHER DOES IT CONVEY ANY LICENSE UNDER ITS PATENT RIGHTS, NOR THE RIGHTS OF OTHERS.

LIFE SUPPORT POLICY

FAIRCHILD'S PRODUCTS ARE NOT AUTHORIZED FOR USE AS CRITICAL COMPONENTS IN LIFE SUPPORT DEVICES OR SYSTEMS WITHOUT THE EXPRESS WRITTEN APPROVAL OF FAIRCHILD SEMICONDUCTOR CORPORATION. As used herein:

1. Life support devices or systems are devices or systems which, (a) are intended for surgical implant into the body, or (b) support or sustain life, or (c) whose failure to perform when properly used in accordance with instructions for use provided in the labeling, can be reasonably expected to result in significant injury to the user.
2. A critical component is any component of a life support device or system whose failure to perform can be reasonably expected to cause the failure of the life support device or system, or to affect its safety or effectiveness.

PRODUCT STATUS DEFINITIONS

Definition of Terms

| Datasheet Identification | Product Status | Definition |
|--------------------------|------------------------|---|
| Advance Information | Formative or In Design | This datasheet contains the design specifications for product development. Specifications may change in any manner without notice. |
| Preliminary | First Production | This datasheet contains preliminary data, and supplementary data will be published at a later date. Fairchild Semiconductor reserves the right to make changes at any time without notice in order to improve design. |
| No Identification Needed | Full Production | This datasheet contains final specifications. Fairchild Semiconductor reserves the right to make changes at any time without notice in order to improve design. |
| Obsolete | Not In Production | This datasheet contains specifications on a product that has been discontinued by Fairchild semiconductor. The datasheet is printed for reference information only. |