

MITSUBISHI GATE TURN-OFF THYRISTORS

FG4000GX-90DA

HIGH POWER INVERTER USE
PRESS PACK TYPE

FG4000GX-90DA



- ITQRM Repetitive controllable on-state current 4000A
- IT(AV) Average on-state current 1200A
- VDRM Repetitive peak off state voltage 4500V
- Anode short type

OUTLINE DRAWING

Dimensions in mm

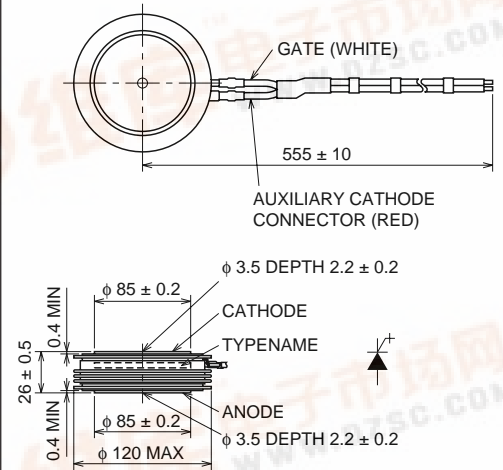

APPLICATION

Inverters, D.C. choppers, Induction heaters, D.C. to D.C. converters.

MAXIMUM RATINGS

| Symbol | Parameter | Voltage class | | Unit |
|--------|--|---------------|--|------|
| | | 90DA | | |
| VRRM | Repetitive peak reverse voltage | 17 | | V |
| VRSM | Non-repetitive peak reverse voltage | 17 | | V |
| VR(DC) | DC reverse voltage | 17 | | V |
| VDRM | Repetitive peak off-state voltage* | 4500 | | V |
| VDSM | Non-repetitive peak off-state voltage* | 4500 | | V |
| VD(DC) | DC off-state voltage* | 3600 | | V |
| VLTD5 | Long term DC stability voltage* | 3000 | | V |

* : VGK = -2V

| Symbol | Parameter | Conditions | Ratings | Unit |
|------------------|---|---|-----------------------|------------------|
| ITQRM | Repetitive controllable on-state current | VDM = 4500V, Tj = 125°C, Cs = 4.0μF, Ls = 0.2μH | 4000 | A |
| IT(RMS) | RMS on-state current | | 1800 | A |
| IT(AV) | Average on-state current | f = 60Hz, sine wave θ = 180°, Tf = 70°C | 1200 | A |
| ITSM | Surge (non-repetitive) on-state current | One half cycle at 60Hz | 25 | kA |
| I ² t | Current-squared, time integration | One cycle at 60Hz | 2.6 × 10 ⁶ | A ² s |
| diT/dt | Critical rate of rise of on-state current | VD = 3400V, IGM = 25A, Tj = 125°C | 500 | A/μs |
| VFGM | Peak forward gate voltage | | 10 | V |
| VRGM | Peak reverse gate voltage | | 17 | V |
| IFGM | Peak forward gate current | | 130 | A |
| IRGM | Peak gate reverse current | | 900 | A |
| PFGM | Peak forward gate power dissipation | | 520 | W |
| PRGM | Peak reverse gate power dissipation | | 33 | kW |
| PFG(AV) | Average forward gate power dissipation | | 130 | W |
| PRG(AV) | Average reverse gate power dissipation | | 300 | W |
| Tj | Junction temperature | | -40 ~ +125 | °C |
| Tstg | Storage temperature | | -40 ~ +150 | °C |
| — | Mounting force required | Recommended value 42 | 35 ~ 48 | kN |
| — | Weight | Standard value | 1220 | g |

FG4000GX-90DA

HIGH POWER INVERTER USE
PRESS PACK TYPE

ELECTRICAL CHARACTERISTICS

| Symbol | Parameter | Test conditions | Limits | | | Unit |
|----------------------|--|--|--------|-----|-------|------|
| | | | Min | Typ | Max | |
| V _{TM} | On-state voltage | T _J = 125°C, I _{TM} = 4000A, Instantaneous measurement | — | — | 4.3 | V |
| I _{RRM} | Repetitive peak reverse current | T _J = 125°C, V _{RRM} Applied | — | — | 10 | mA |
| I _{DRM} | Repetitive peak off-state current | T _J = 125°C, V _{DRM} Applied, V _{GK} = -2V | — | — | 150 | mA |
| I _{RG} | Reverse gate current | T _J = 125°C, V _{RG} = 17V | — | — | 10 | mA |
| dv/dt | Critical rate of rise of off-state voltage | T _J = 125°C, V _D = 2250V, V _{GK} = -2V | 1000 | — | — | V/μs |
| t _{gt} | Turn-on time | T _J = 125°C, I _{TM} = 4000A, I _{GM} = 25A, V _D = 3400V | — | — | 8 | μs |
| t _{gq} | Turn-off time | T _J = 125°C, I _{TM} = 4000A, V _{DM} = 4500V, diGQ/dt = -50A/μs V _{RG} = 17V, C _S = 4.0μF, L _S = 0.2μH | — | — | 35 | μs |
| I _{GQM} | Peak gate turn-off current | | — | 900 | — | A |
| V _{GT} | Gate trigger voltage | DC METHOD : V _D = 24V, R _L = 0.1Ω, T _J = 25°C | — | — | 1.5 | V |
| I _{GT} | Gate trigger current | | — | — | 2500 | mA |
| R _{th(j-f)} | Thermal resistance | Junction to fin | — | — | 0.011 | °C/W |

PERFORMANCE CURVES

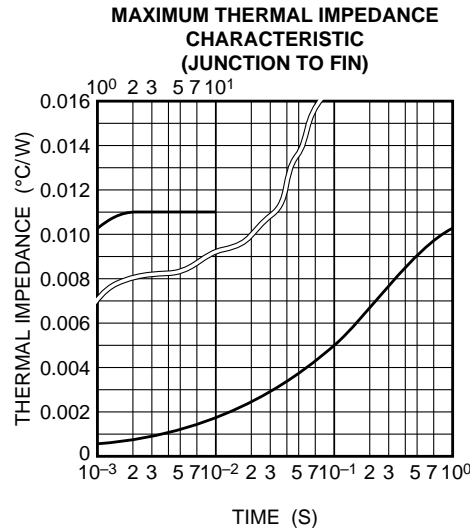
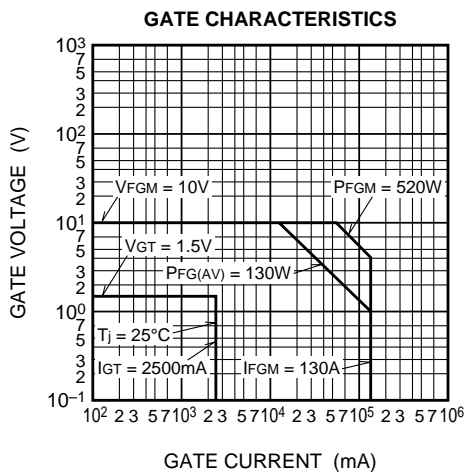
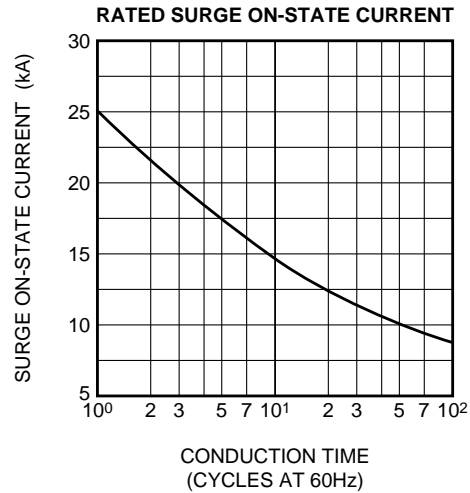
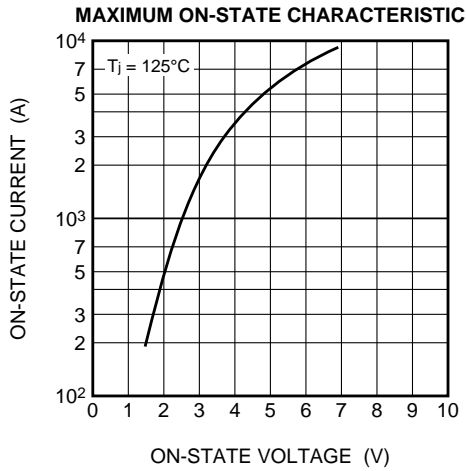

FG4000GX-90DA

HIGH POWER INVERTER USE
PRESS PACK TYPE

MAXIMUM ON-STATE POWER DISSIPATION CHARACTERISTICS (SINGLE-PHASE HALF WAVE)

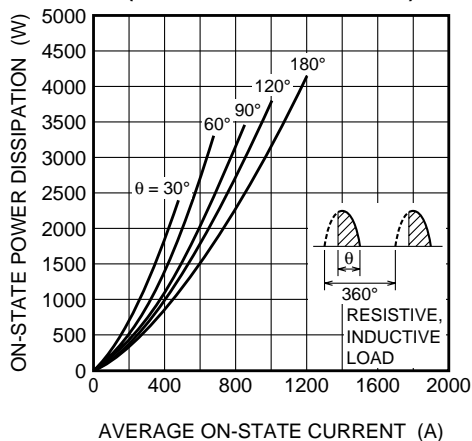

ALLOWABLE FIN TEMPERATURE VS. AVERAGE ON-STATE CURRENT (SINGLE-PHASE HALF WAVE)

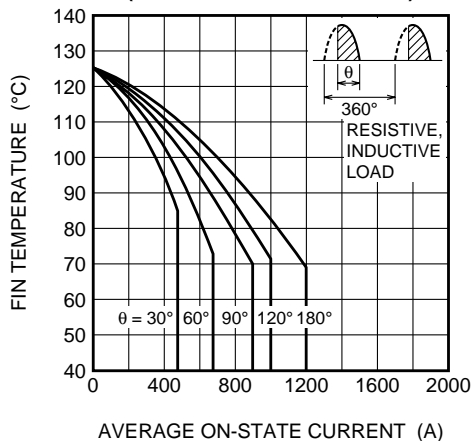

MAXIMUM ON-STATE POWER DISSIPATION CHARACTERISTICS (RECTANGULAR WAVE)

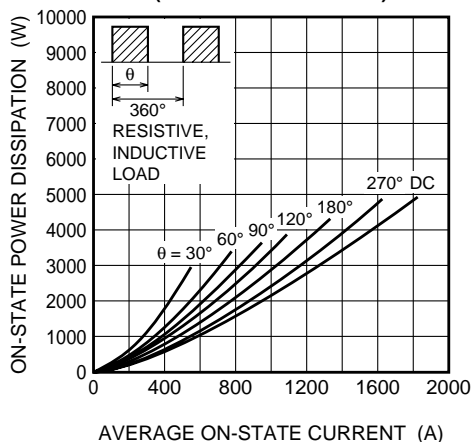

ALLOWABLE FIN TEMPERATURE VS. AVERAGE ON-STATE CURRENT (RECTANGULAR WAVE)

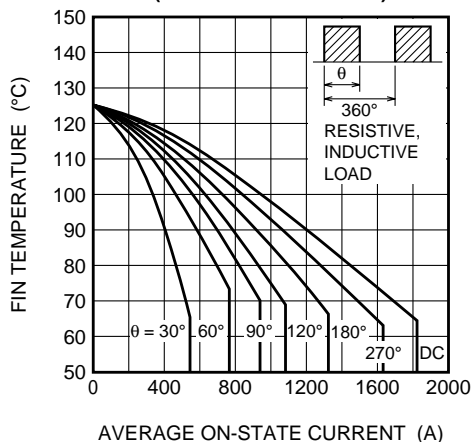

GATE TRIGGER CURRENT VS. JUNCTION TEMPERATURE (MAXIMUM)

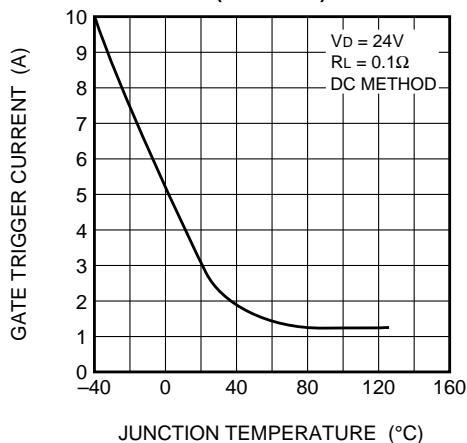

TURN ON TIME, TURN ON DELAY TIME VS. TURN ON GATE CURRENT (TYPICAL)

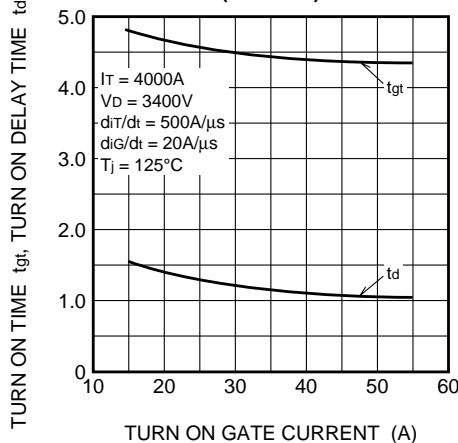

FG4000GX-90DA

HIGH POWER INVERTER USE
PRESS PACK TYPE

