

SFH600-0, SFH600-1, SFH600-2, SFH600-3, SFH600-4
 SFH601-1, SFH601-2, SFH601-3, SFH601-4, SFH601-5
 SFH609-1, SFH609-2, SFH609-3, SFH609-4, SFH609-5



**OPTICALLY COUPLED
 ISOLATOR
 PHOTOTRANSISTOR OUTPUT**

APPROVALS

- UL recognised, File No. E91231
- 'X' SPECIFICATION APPROVALS
 - VDE 0884 in 3 available lead forms :-
 - STD
 - G form
 - SMD approved to CECC 00802
 Excludes SFH609-4,-5
 - Certified to EN60950 by the following Test Bodies :-
 - Nemko - Certificate No. P01102465
 - Fimko - Certificate No. FI18162
 - Semko - Reference No. 0202041/01-25
 - Demko - Certificate No. 311161-01
 Excludes SFH600-0, 601-2, 609-4,-5
 - BSI approved - Certificate No. 8001
 - Excludes SFH609-4,-5

DESCRIPTION

The SFH600-, SFH601-, SFH609-_ series of optically coupled isolators consist of an infrared light emitting diode and a NPN silicon photo transistor in a standard 6 pin dual in line plastic package.

FEATURES

- Options :-
 - 10mm lead spread - add G after part no.
 - Surface mount - add SM after part no.
 - Tape&reel - add SMT&R after part no.
- High BV_{CEO} (70V, 90V, 100V min)
- High Isolation Voltage ($5.3kV_{RMS}$, $7.5kV_{PK}$)
- All electrical parameters 100% tested
- Custom electrical selections available

APPLICATIONS

- DC motor controllers
- Industrial systems controllers
- Measuring instruments
- Signal transmission between systems of different potentials and impedances

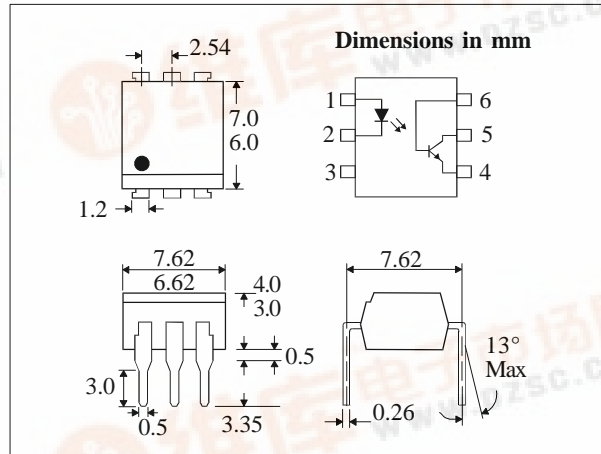
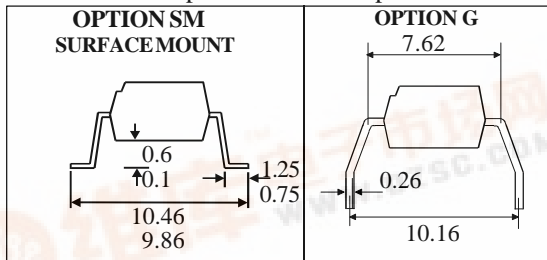

**ABSOLUTE MAXIMUM RATINGS
 (25°C unless otherwise specified)**

Storage Temperature	-55°C to + 150°C
Operating Temperature	-55°C to + 100°C
Lead Soldering Temperature (1/16 inch (1.6mm) from case for 10 secs)	260°C

INPUT DIODE

Forward Current	60mA
Reverse Voltage	6V
Power Dissipation	105mW

OUTPUT TRANSISTOR

Collector-emitter Voltage BV_{CEO}	70V
SFH600-0,1,2,3,4	70V
SFH601-1,2,3,4,5	100V
SFH609-1,2,3,4,5	90V
Collector-base Voltage BV_{CBO}	70V
SFH600-0,1,2,3,4	70V
SFH601-1,2,3,4,5	100V
SFH609-1,2,3,4,5	90V
Emitter-collector Voltage BV_{ECO}	6V
Power Dissipation	160mW

POWER DISSIPATION

Total Power Dissipation	200mW
(derate linearly 2.67mW/°C above 25°C)	

ISOCOM COMPONENTS LTD
 Unit 25B, Park View Road West,
 Park View Industrial Estate, Brenda Road
 Hartlepool, Cleveland, TS25 1YD
 Tel: (01429) 863609 Fax :(01429) 863581

ISOCOM INC
 1024 S. Greenville Ave, Suite 240,
 Allen, TX 75002 USA
 Tel: (214)495-0755 Fax: (214)495-0901
 e-mail info@isocom.com
 http://www.isocom.com



ELECTRICAL CHARACTERISTICS ($T_A = 25^\circ\text{C}$ Unless otherwise noted)

PARAMETER		MIN	TYP	MAX	UNITS	TEST CONDITION
Input	Forward Voltage (V_F)		1.2	1.65	V	$I_F = 60\text{mA}$
	Reverse Current (I_R)			10	μA	$V_R = 6\text{V}$
Output	Collector-emitter Breakdown (BV_{CEO}) SFH600-0, 1, 2, 3, 4	70			V	$I_C = 1\text{mA}$ (Note 2)
	SFH601-1, 2, 3, 4, 5	100			V	
	SFH609-1, 2, 3, 4, 5	90			V	
	Collector-base Breakdown (BV_{CBO}) SFH600-0, 1, 2, 3, 4	70			V	$I_C = 100\mu\text{A}$
	SFH601-1, 2, 3, 4, 5	100			V	
	SFH609-1, 2, 3, 4, 5	90			V	
	Emitter-collector Breakdown (BV_{ECO})	6			V	$I_E = 100\mu\text{A}$
	Collector-emitter Dark Current (I_{CEO})			50	nA	$V_{CE} = 10\text{V}$
Coupled	Current Transfer Ratio (CTR) (Note 2) SFH600-0, SFH601-1, SFH609-1	40		80	%	$10\text{mA } I_F, 5\text{V } V_{CE}$
	SFH600-1, SFH601-2, SFH609-2	63		125	%	$10\text{mA } I_F, 5\text{V } V_{CE}$
	SFH600-2, SFH601-3, SFH609-3	100		200	%	$10\text{mA } I_F, 5\text{V } V_{CE}$
	SFH600-3, SFH601-4, SFH609-4	160		320	%	$10\text{mA } I_F, 5\text{V } V_{CE}$
	SFH600-4, SFH601-5, SFH609-5	200		400	%	$10\text{mA } I_F, 5\text{V } V_{CE}$
	SFH600-0, SFH601-1, SFH609-1	13			%	$1\text{mA } I_F, 5\text{V } V_{CE}$
	SFH600-1, SFH601-2, SFH609-2	22			%	$1\text{mA } I_F, 5\text{V } V_{CE}$
	SFH600-2, SFH601-3, SFH609-3	34			%	$1\text{mA } I_F, 5\text{V } V_{CE}$
	SFH600-3, SFH601-4, SFH609-4	56			%	$1\text{mA } I_F, 5\text{V } V_{CE}$
	SFH600-4, SFH601-5, SFH609-5	68			%	$1\text{mA } I_F, 5\text{V } V_{CE}$
	Collector-emitter Saturation Voltage $V_{CE(SAT)}$			0.4	V	$10\text{mA } I_F, 2.5\text{mA}$
	Input to Output Isolation Voltage V_{ISO}	5300			V_{RMS}	See note 1
		7500			V_{PK}	See note 1
Input-output Isolation Resistance R_{ISO}	5×10^{10}			Ω	$V_{IO} = 500\text{V}$ (note 1)	

Note 1 Measured with input leads shorted together and output leads shorted together.

Note 2 Special Selections are available on request. Please consult the factory.

TYPICAL SWITCHING CHARACTERISTICS

1. Linear Operation (without saturation) Fig 1 .

$I_F = 10\text{mA}, V_{CC} = 5\text{V}, R_L = 75\Omega$

			UNITS
Turn-on Time	t_{on}	3.0	μs
Rise Time	t_r	2.0	μs
Turn-off Time	t_{off}	2.3	μs
Fall Time	t_f	2.0	μs
Cut-off Frequency	F_{CO}	250	kHz

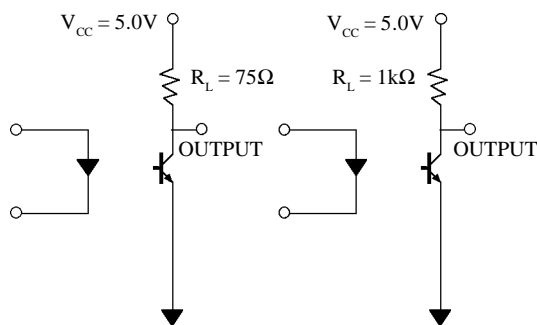

FIG 1

FIG 2

2. Switching Operation (with saturation) Fig 2

$V_{CC} = 5\text{V}, R_L = 1\text{k}\Omega$

GROUP	600-0 601/9-1 ($I_F=20\text{mA}$)	600-1&2 601/9-2&3 ($I_F=10\text{mA}$)	600-3 601/9-4&5 ($I_F=5\text{mA}$)	UNITS	
Turn-on Time	t_{on}	3.0	4.2	6.0	μs
Rise Time	t_r	2.0	3.0	4.6	μs
Turn-off Time	t_{off}	18	23	25	μs
Fall Time	t_f	11	14	15	μs
	V_{CESAT}	≤ 0.4			V

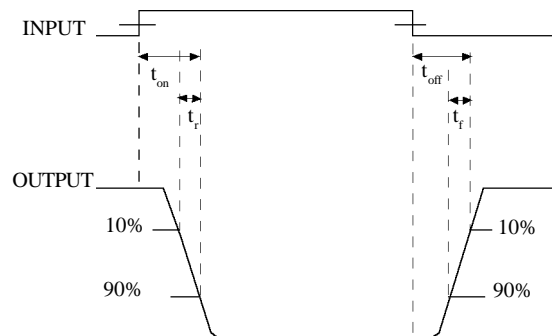

Collector Power Dissipation vs. Ambient Temperature

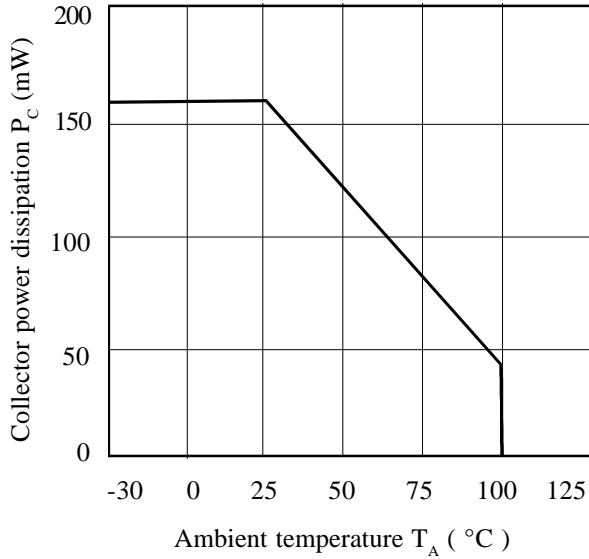

Collector Current vs. Collector-emitter Voltage (normalised to SFH601-3)

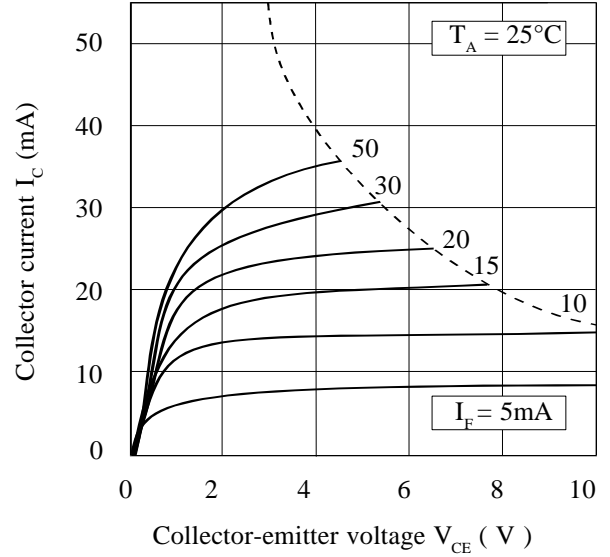

Forward Current vs. Ambient Temperature

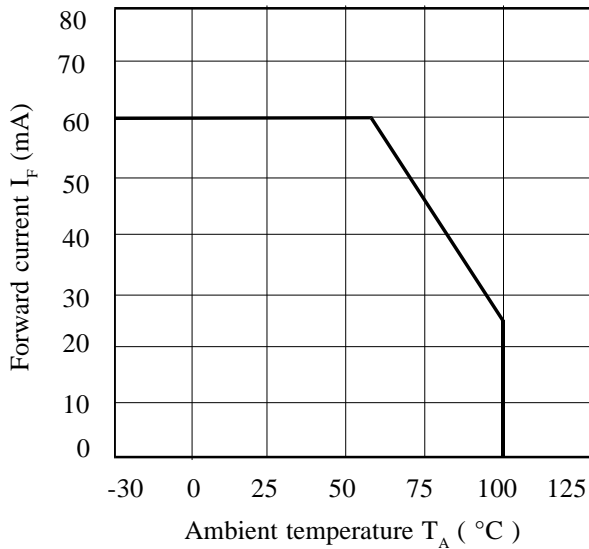

Current Transfer Ratio vs. Forward Current

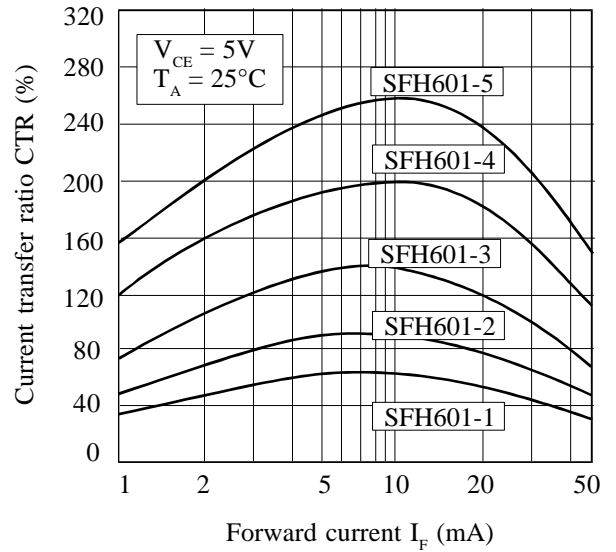

Relative Current Transfer Ratio vs. Ambient Temperature

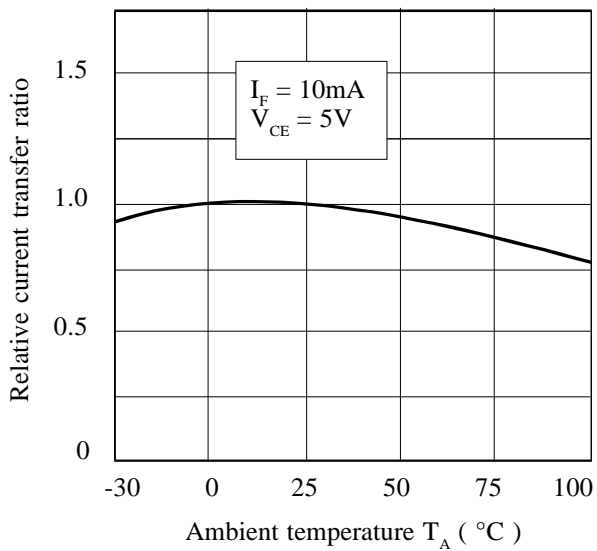

Collector-emitter Saturation Voltage vs. Ambient Temperature

