

FAIRCHILD
SEMICONDUCTOR®

FJPF5021

High Voltage and High Reliability

- High Speed Switching : $t_F = 0.1\mu s$ (Typ.)
- Wide SOA

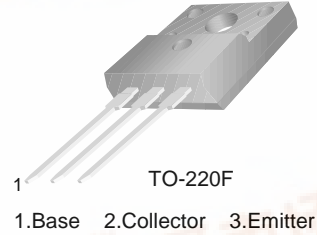

NPN Silicon Transistor

Absolute Maximum Ratings $T_C=25^\circ C$ unless otherwise noted

| Symbol | Parameter | Value | Units |
|-----------|--|------------|------------|
| V_{CBO} | Collector-Base Voltage | 800 | V |
| V_{CEO} | Collector-Emitter Voltage | 500 | V |
| V_{EBO} | Emitter-Base Voltage | 7 | V |
| I_C | Collector Current (DC) | 5 | A |
| I_{CP} | Collector Current (Pulse) | 10 | A |
| I_B | Base Current | 2 | A |
| P_C | Collector Dissipation ($T_C=25^\circ C$) | 40 | W |
| T_J | Junction Temperature | 150 | $^\circ C$ |
| T_{STG} | Storage Temperature | - 55 ~ 150 | $^\circ C$ |

Electrical Characteristics $T_C=25^\circ C$ unless otherwise noted

| Symbol | Parameter | Test Condition | Min. | Typ. | Max. | Units |
|------------------------|--------------------------------------|---|---------|------|------|---------|
| BV_{CBO} | Collector-Base Breakdown Voltage | $I_C = 1mA, I_E = 0$ | 800 | | | V |
| BV_{CEO} | Collector-Emitter Sustaining Voltage | $I_C = 5mA, I_B = 0$ | 500 | | | V |
| BV_{EBO} | Emitter-Base Breakdown Voltage | $I_E = 1mA, I_C = 0$ | 7 | | | V |
| $V_{CEX(sus)}$ | Collector-Emitter Sustaining Voltage | $I_C = 2.5A, I_{B1} = -I_{B2} = 1A$ $L = 1mH, Clamped$ | 500 | | | V |
| I_{CBO} | Collector Cut-off Current | $V_{CB} = 500V, I_E = 0$ | | | 10 | μA |
| I_{EBO} | Emitter Cut-off Current | $V_{EB} = 5V, I_C = 0$ | | | 10 | μA |
| h_{FE1} h_{FE2} | DC Current Gain | $V_{CE} = 5V, I_C = 0.6A$ $V_{CE} = 5V, I_C = 3A$ | 15 8 | | 50 | |
| $V_{CE(sat)}$ | Collector-Emitter Saturation Voltage | $I_C = 3A, I_B = 0.6A$ | | | 1 | V |
| $V_{BE(sat)}$ | Base-Emitter Saturation Voltage | $I_C = 3A, I_B = 0.6A$ | | | 1.5 | V |
| C_{ob} | Output Capacitance | $V_{CB} = 10V, I_E = 0, f = 1MHz$ | | 80 | | pF |
| f_T | Current Gain Bandwidth Product | $V_{CE} = 10V, I_C = 0.6A$ | | 15 | | MHz |
| t_{ON} | Turn On Time | $V_{CC} = 200V$ | | | 0.5 | μs |
| t_{STG} | Storage Time | $I_C = 5I_{B1} = -2.5I_{B2} = 4A$ | | | 3 | μs |
| t_F | Fall Time | $R_L = 50\Omega$ | | 0.1 | 0.3 | μs |

h_{FE} Classification

| Classification | R | O | Y |
|----------------|---------|---------|---------|
| h_{FE1} | 15 ~ 30 | 20 ~ 40 | 30 ~ 50 |



Typical Characteristics

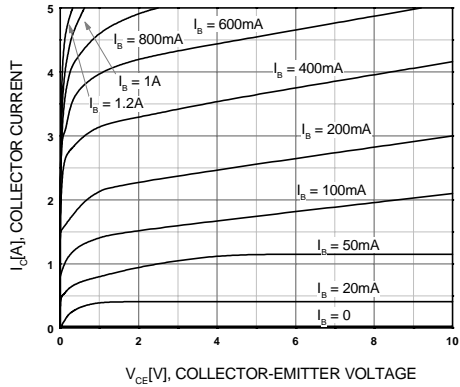

Figure 1. Static Characteristic

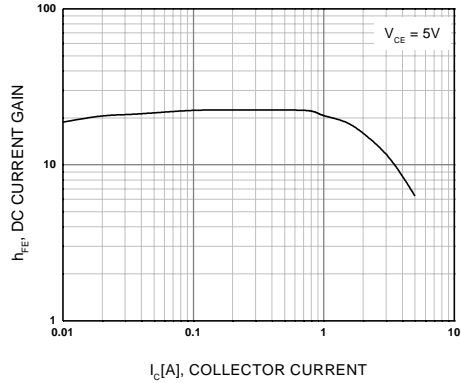

Figure 2. DC current Gain

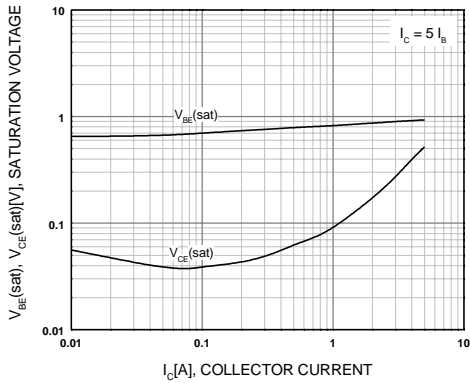

Figure 3. Base-Emitter Saturation Voltage
Collector-Emitter Saturation Voltage

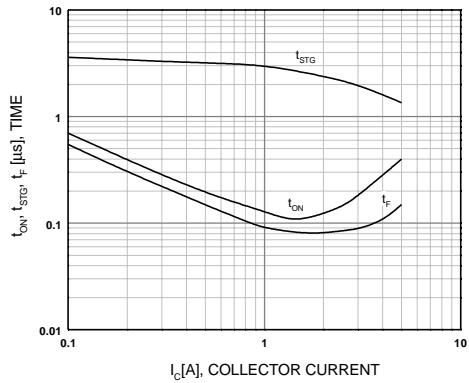

Figure 4. Switching Time

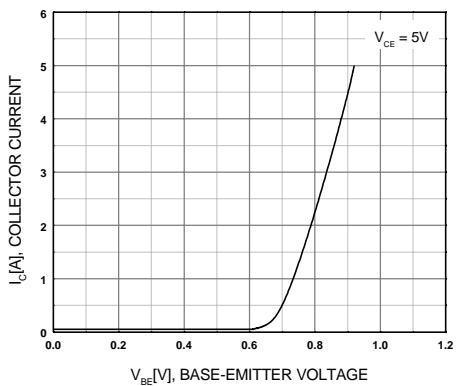

Figure 5. Base-Emitter On Voltage

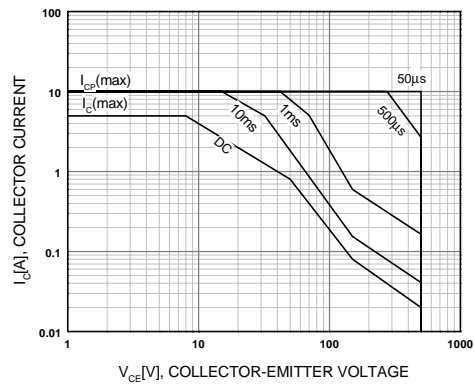

Figure 6. Forward Bias Safe Operating Area

Typical Characteristics (Continued)

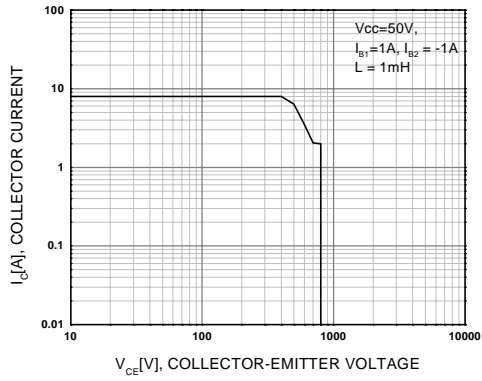

Figure 7. Reverse Bias Safe Operating Area

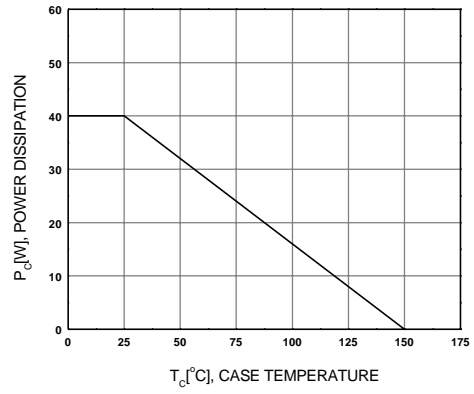
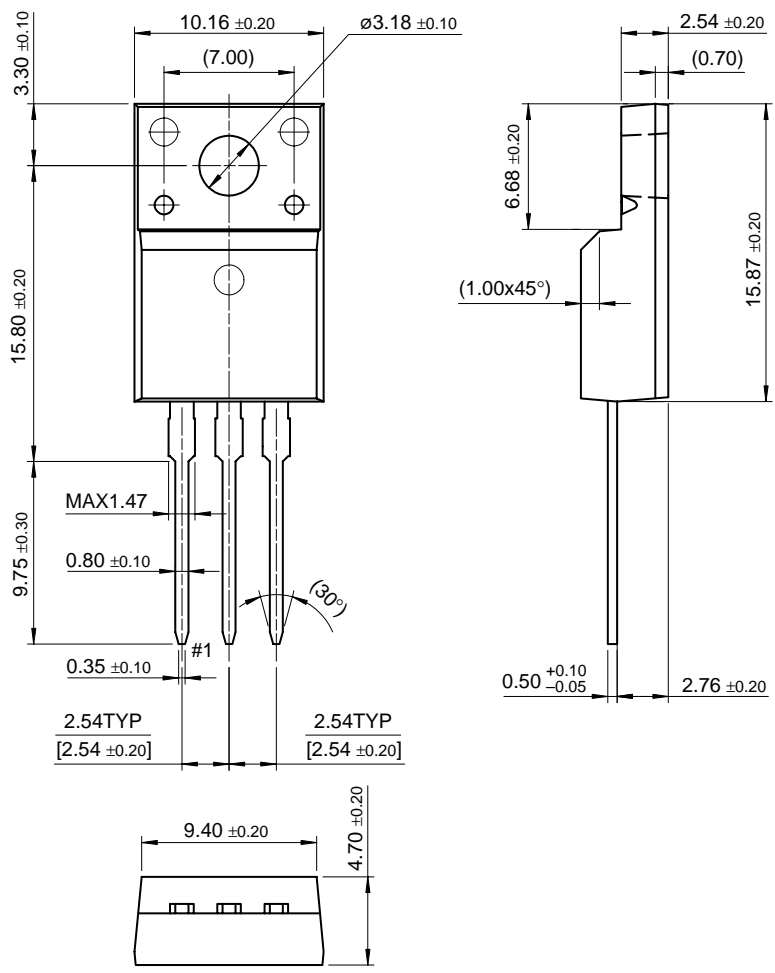

Figure 8. Power Derating

Package Dimensions

FJPF5021

TO-220F



Dimensions in Millimeters

TRADEMARKS

The following are registered and unregistered trademarks Fairchild Semiconductor owns or is authorized to use and is not intended to be an exhaustive list of all such trademarks.

| | | | | |
|--------------------------------------|---------------------|--------------------|---------------------|-----------------|
| ACEx™ | FACT™ | ImpliedDisconnect™ | PACMAN™ | SPM™ |
| ActiveArray™ | FACT Quiet series™ | ISOPLANAR™ | POP™ | Stealth™ |
| Bottomless™ | FAST® | LittleFET™ | Power247™ | SuperSOT™-3 |
| CoolFET™ | FASTr™ | MicroFET™ | PowerTrench® | SuperSOT™-6 |
| CROSSVOLT™ | FRFET™ | MicroPak™ | QFET™ | SuperSOT™-8 |
| DOMET™ | GlobalOptoisolator™ | MICROWIRE™ | QS™ | SyncFET™ |
| EcoSPARK™ | GTO™ | MSX™ | QT Optoelectronics™ | TinyLogic® |
| E ² CMOS™ | HiSeC™ | MSXPro™ | Quiet Series™ | TruTranslation™ |
| EnSigna™ | I ² C™ | OCX™ | RapidConfigure™ | UHC™ |
| Across the board. Around the world.™ | | OCXPro™ | RapidConnect™ | UltraFET® |
| The Power Franchise™ | | OPTOLOGIC® | SILENT SWITCHER® | VCX™ |
| Programmable Active Droop™ | | OPTOPLANAR™ | SMART START™ | |

DISCLAIMER

FAIRCHILD SEMICONDUCTOR RESERVES THE RIGHT TO MAKE CHANGES WITHOUT FURTHER NOTICE TO ANY PRODUCTS HEREIN TO IMPROVE RELIABILITY, FUNCTION OR DESIGN. FAIRCHILD DOES NOT ASSUME ANY LIABILITY ARISING OUT OF THE APPLICATION OR USE OF ANY PRODUCT OR CIRCUIT DESCRIBED HEREIN; NEITHER DOES IT CONVEY ANY LICENSE UNDER ITS PATENT RIGHTS, NOR THE RIGHTS OF OTHERS.

LIFE SUPPORT POLICY

FAIRCHILD'S PRODUCTS ARE NOT AUTHORIZED FOR USE AS CRITICAL COMPONENTS IN LIFE SUPPORT DEVICES OR SYSTEMS WITHOUT THE EXPRESS WRITTEN APPROVAL OF FAIRCHILD SEMICONDUCTOR CORPORATION.

As used herein:

1. Life support devices or systems are devices or systems which, (a) are intended for surgical implant into the body, or (b) support or sustain life, or (c) whose failure to perform when properly used in accordance with instructions for use provided in the labeling, can be reasonably expected to result in significant injury to the user.
2. A critical component is any component of a life support device or system whose failure to perform can be reasonably expected to cause the failure of the life support device or system, or to affect its safety or effectiveness.

PRODUCT STATUS DEFINITIONS

Definition of Terms

| Datasheet Identification | Product Status | Definition |
|--------------------------|------------------------|---|
| Advance Information | Formative or In Design | This datasheet contains the design specifications for product development. Specifications may change in any manner without notice. |
| Preliminary | First Production | This datasheet contains preliminary data, and supplementary data will be published at a later date. Fairchild Semiconductor reserves the right to make changes at any time without notice in order to improve design. |
| No Identification Needed | Full Production | This datasheet contains final specifications. Fairchild Semiconductor reserves the right to make changes at any time without notice in order to improve design. |
| Obsolete | Not In Production | This datasheet contains specifications on a product that has been discontinued by Fairchild semiconductor. The datasheet is printed for reference information only. |